

GSM and EDGE Guide

Agilent Technologies PSA Series and VSA E4406A

Options 202, 252, BAH

This manual provides documentation for the following instruments:

Transmitter Tester:

E4406A

Spectrum Analyzers:

E4440A (3 Hz - 26.5 GHz)

E4443A (3 Hz - 6.7 GHz)

E4445A (3 Hz - 13.2 GHz)

E4446A (3 Hz - 44.0 GHz)

E4447A (3 Hz - 42.98 GHz)

E4448A (3 Hz - 50.0 GHz)



Agilent Technologies

Manufacturing Part Number: E4406-90306

Supersedes E4406-90287

Printed in USA

June 2007

© Copyright 1999 - 2007 Agilent Technologies, Inc.

The information contained in this document is subject to change without notice.

Agilent Technologies makes no warranty of any kind with regard to this material, including but not limited to, the implied warranties of merchantability and fitness for a particular purpose. Agilent Technologies shall not be liable for errors contained herein or for incidental or consequential damages in connection with the furnishing, performance, or use of this material.

1. Introduction to GSM and EDGE

| | |
|---|----|
| What Does the Agilent PSA Series and VSA E4406A do? | 34 |
| Installing Optional Measurement Personalities | 35 |
| Do You Have Enough Memory to Load All Your Personality Options? | 35 |
| How to Predict Your Memory Requirements | 37 |
| Loading an Optional Measurement Personality | 39 |
| Obtaining and Installing a License Key | 40 |
| Viewing a License Key | 41 |
| Using the Delete License Key on PSA | 42 |
| Using the Uninstall Key on E4406A | 42 |
| Ordering Optional Measurement Personalities | 43 |

2. Making Measurements

| | |
|--|----|
| GSM and EDGE Measurements | 46 |
| Setting up and Making a Measurement | 48 |
| Making the Initial Signal Connection | 48 |
| Using Instrument Mode and Measurement Presets | 48 |
| The 3 Steps to Set Up and Make Measurements | 49 |
| EDGE Power vs. Time (PVT) Measurements | 50 |
| Configuring the Measurement System | 50 |
| Setting the BTS (Example) | 51 |
| Measurement Procedure | 51 |
| Results | 52 |
| For More Information | 55 |
| Troubleshooting Hints | 55 |
| EDGE Error Vector Magnitude (EVM) Measurements | 56 |
| Configuring the Measurement System | 56 |
| Setting the BTS (Example) | 57 |
| Measurement Procedure | 57 |
| Troubleshooting Hints | 60 |
| EDGE Output RF Spectrum (ORFS) Measurements | 62 |
| Configuring the Measurement System | 62 |
| Setting the BTS (Example) | 63 |
| Measurement Procedure | 63 |
| EDGE ORFS Measurement Results | 65 |
| EDGE Tx Band Spur Measurements | 74 |
| Configuring the Measurement System | 74 |
| Setting the BTS (Example) | 75 |
| Measurement Procedure | 75 |
| Results | 76 |
| Troubleshooting Hints | 76 |
| GMSK Output RF Spectrum (ORFS) Measurements | 77 |
| Configuring the Measurement System | 77 |
| Setting the BTS (Example) | 78 |
| Measurement Procedure | 78 |
| GMSK ORFS Measurement Results | 80 |
| GMSK Phase and Frequency Error Measurements | 89 |
| Configuring the Measurement System | 89 |

Contents

| | |
|--|-----|
| Setting the BTS (Example) | 90 |
| Measurement Procedure | 90 |
| For More Information. | 93 |
| Troubleshooting Hints | 93 |
| GMSK Power vs. Time (PvT) Measurements | 94 |
| Configuring the Measurement System | 94 |
| Setting the BTS (Example) | 95 |
| Measurement Procedure | 95 |
| Results | 96 |
| Troubleshooting Hints | 100 |
| GMSK Transmitter Band Spurious Signal (Tx Band Spur) Measurements | 101 |
| Configuring the Measurement System | 101 |
| Setting the BTS (Example) | 102 |
| Measurement Procedure | 102 |
| Results | 103 |
| Troubleshooting Hints | 103 |
| Spectrum (Frequency Domain) Measurements | 104 |
| Configuring the Measurement System | 104 |
| Setting the BTS | 105 |
| Measurement Procedure | 105 |
| Transmit Power Measurements | 115 |
| Configuring the Measurement System | 115 |
| Setting the BTS (Example) | 115 |
| Measurement Procedure | 116 |
| Troubleshooting Hints | 118 |
| Waveform (Time Domain) Measurements | 119 |
| Configuring the Measurement System | 119 |
| Measurement Procedure | 120 |
| Using Option B7C Baseband I/Q Inputs | 131 |
| Baseband I/Q Measurements Available for E4406A VSA Series Transmitter Tester | 131 |
| Baseband I/Q Measurement Overview | 131 |
| Baseband I/Q Measurement Result Examples | 132 |
| Using Basic Mode | 136 |
| Basic Mode in E4406A VSA Series Transmitter Testers | 136 |
| Basic Mode in PSA Series Spectrum Analyzers | 136 |
| Interpreting Error Codes | 137 |
| | |
| 3. Key Reference | |
| Instrument Front Panel Highlights | 140 |
| Selected E4406A VSA and PSA Front-Panel Features | 141 |
| Front Panel Keys | 143 |
| FREQUENCY Channel Key Menu | 143 |
| Measurement Control Key Menu | 146 |
| MODE Key Menu | 146 |
| Mode Setup Key Menu | 147 |
| Input/Output Key Menu | 152 |
| Measurement Keys | 156 |
| EDGE EVM (Error Vector Magnitude) | |
| Measurement Keys | 156 |

| | |
|---|-----|
| EDGE Output RF Spectrum Measurement Keys | 166 |
| EDGE Power vs. Time Measurement Keys | 177 |
| EDGE Tx Band Spur Measurement Keys | 184 |
| GMSK Output RF Spectrum Measurement Keys | 187 |
| GMSK Phase and Frequency Error Measurement Keys | 197 |
| GMSK Power vs. Time Measurement Keys | 204 |
| GMSK Tx Band Spur Measurement Keys | 214 |
| Spectrum (Frequency Domain) Keys | 217 |
| Transmit Power Measurement Keys | 234 |
| Waveform (Time Domain) Keys | 240 |
| Baseband I/Q Inputs (Option B7C) Keys | 259 |
| Input Port Key Menu | 259 |
| I/Q Setup Key Menu | 260 |
| I/Q Range Key Menu | 262 |
| Baseband I/Q Key Access Locations | 263 |
| | |
| 4. Programming Commands | |
| SCPI Command Subsystems | 266 |
| Programming Command Compatibility | |
| Across Model Numbers and Across Modes | 267 |
| Across PSA Modes: Command Subsystem Similarities | 267 |
| Across PSA Modes: Specific Command Differences | 269 |
| Using Applications in PSA Series vs. VSA E4406A | 270 |
| CALCulate Subsystem | 272 |
| Test Current Results Against all Limits | 272 |
| Data Query | 272 |
| Calculate/Compress Trace Data Query | 272 |
| Calculate Peaks of Trace Data | 282 |
| CALCulate EDGE EVM Subsystem | 284 |
| EDGE TX Band Spur Calculate Commands | 300 |
| CALCulate:MARKers Subsystem | 301 |
| CALCulate Phase and Frequency Error Subsystem | 312 |
| Baseband I/Q - Spectrum I/Q Marker Query | 316 |
| Transmit Band Spurious - Limits | 317 |
| Baseband I/Q - Waveform I/Q Marker Query | 317 |
| CONFigure Subsystem | 319 |
| Configure the Selected Measurement | 319 |
| Configure Query | 319 |
| DISPlay Subsystem | 320 |
| Adjacent Channel Power - View Selection | 320 |
| Turn the Display On/Off | 320 |
| EDGE PVT - Limit Mask On/Off | 321 |
| EDGE PVT - View Selection (PSA Only) | 321 |
| EDGE Output RF Spectrum - View Selection (PSA Only) | 322 |
| EDGE EVM - View Selection (PSA Only) | 323 |
| GMSK PVT - View Selection (PSA Only) | 324 |
| GMSK Output RF Spectrum - View Selection (PSA Only) | 325 |
| GMSK Phase & Frequency - View Selection (PSA Only) | 326 |
| Select Display Format | 327 |

Contents

| | |
|--|-----|
| Select Display Format | 327 |
| Full Screen Display (PSA Only) | 328 |
| PVT - Limit Mask Display | 328 |
| Spectrum - Y-Axis Scale/Div | 328 |
| Spectrum - Y-Axis Reference Level | 330 |
| Turn a Trace Display On/Off | 331 |
| Waveform - Y-Axis Scale/Div | 335 |
| Waveform - Y-Axis Reference Level | 336 |
| FETCh Subsystem. | 338 |
| Fetch the Current Measurement Results | 338 |
| FORMat Subsystem | 339 |
| Byte Order | 339 |
| Numeric Data Format | 339 |
| INITiate Subsystem. | 341 |
| Take New Data Acquisition for Selected Measurement | 341 |
| Continuous or Single Measurements | 341 |
| Take New Data Acquisitions | 342 |
| Restart the Measurement | 342 |
| INSTrument Subsystem | 343 |
| Catalog Query | 343 |
| Select Application by Number | 343 |
| Select Application | 344 |
| MEASure Group of Commands. | 347 |
| Command Interactions: MEASure, CONFIgure, FETCh, INITiate and READ | 348 |
| 50 MHz Amplitude Reference Measurement | 352 |
| EDGE Error Vector Magnitude Measurement | 353 |
| EDGE Output RF Spectrum Measurement | 357 |
| EDGE Power vs. Time Measurement | 361 |
| EDGE Transmit Band Spurs Measure Commands | 364 |
| GMSK Output RF Spectrum Measurement | 366 |
| GMSK Phase & Frequency Error Measurement | 370 |
| GMSK Power vs. Time Measurement | 373 |
| Sensor Measurement | 377 |
| Spectrum (Frequency Domain) Measurement | 378 |
| Timebase Frequency Measurement | 381 |
| GMSK Transmit Band Spurs Measurement | 382 |
| GMSK Transmit Power Measurement | 383 |
| Waveform (Time Domain) Measurement | 385 |
| READ Subsystem | 387 |
| Initiate and Read Measurement Data | 387 |
| SENSE Subsystem | 388 |
| Baseband I/Q Commands (E4406A only) | 388 |
| Channel Commands | 390 |
| Signal Corrections Commands | 395 |
| EDGE Error Vector Magnitude Measurement | 396 |
| EDGE Output RF Spectrum Measurement | 402 |
| EDGE Power vs. Time (Burst Power) Measurement | 419 |
| EDGE Transmit Band Spurs Measurement | 433 |
| RF Input Signal Alignments | 435 |

| | |
|--|-----|
| Frequency Commands | 437 |
| GMSK Output RF Spectrum Measurement | 438 |
| GMSK Phase & Frequency Error Measurement | 454 |
| Select I/Q Power Range (E4406A only) | 458 |
| Select I/Q Voltage Range (E4406A only) | 458 |
| RF Power Commands | 459 |
| GMSK Power vs. Time Measurement | 462 |
| Radio Standards Commands | 478 |
| Reference Oscillator Commands | 482 |
| Spectrum (Frequency-Domain) Measurement | 484 |
| Synchronization Commands | 498 |
| GMSK Transmit Band Spurs Measurement | 499 |
| Transmit Power Measurement | 502 |
| Waveform (Time-Domain) Measurement | 506 |
| TRIGger Subsystem | 514 |
| Automatic Trigger Control | 514 |
| Automatic Trigger Time | 514 |
| External Trigger Delay | 515 |
| External Trigger Level | 515 |
| External Trigger Slope | 515 |
| Frame Trigger Adjust | 516 |
| Frame Trigger Period | 516 |
| Frame Trigger Sync Source | 517 |
| Frame Trigger Synchronization Offset | 517 |
| Trigger Holdoff | 518 |
| Video (IF) Trigger Delay | 518 |
| Video (IF) Trigger Level | 518 |
| Video (IF) Trigger Slope | 519 |
| RF Burst Trigger Delay | 519 |
| RF Burst Trigger Level | 519 |
| RF Burst Trigger Slope | 520 |

5. Concepts

| | |
|---|-----|
| What are GSM and EDGE? | 522 |
| Frequently Used Terms | 525 |
| Mobile Stations and Base Transceiver Stations | 525 |
| Uplink and Downlink | 525 |
| ARFCN | 525 |
| Timeslots | 525 |
| Transmit Power Measurement Concepts | 526 |
| Purpose | 526 |
| Measurement Method | 526 |
| GMSK Power vs. Time Measurement Concepts | 527 |
| Purpose | 527 |
| Measurement Method | 527 |
| Measurement Adjustments | 528 |
| Measurement Results | 531 |
| GMSK Phase and Frequency Error Measurement Concepts | 533 |
| Purpose | 533 |

Contents

| | |
|--|-----|
| Measurement Method | 533 |
| Measurement Adjustments | 533 |
| GMSK Output RF Spectrum Measurement Concepts | 536 |
| Purpose | 536 |
| Measurement Method | 536 |
| Changing the View | 539 |
| GMSK ORFS Measurements on a Single Bursted Slot | 539 |
| GMSK Tx Band Spur Measurement Concepts | 540 |
| Purpose | 540 |
| Measurement Method | 540 |
| Changing the View | 541 |
| EDGE Power vs. Time Measurement Concepts | 542 |
| Purpose | 542 |
| Measurement Method | 542 |
| Measurement Adjustments | 543 |
| EDGE EVM Measurement Concepts | 544 |
| Purpose | 544 |
| Measurement Method | 544 |
| Measurement Adjustments | 544 |
| EDGE Output RF Spectrum Measurement Concepts | 549 |
| Purpose | 549 |
| Measurement Method | 549 |
| Measurement Adjustments | 553 |
| EDGE ORFS Measurements on a Single Bursted Slot | 553 |
| EDGE Tx Band Spur Measurement Concepts | 554 |
| Purpose | 554 |
| Measurement Method | 554 |
| Measurement Adjustments | 555 |
| Spectrum (Frequency Domain) Measurement Concepts | 556 |
| Purpose | 556 |
| Measurement Method | 556 |
| Troubleshooting Hints | 556 |
| Waveform (Time Domain) Measurement Concepts | 557 |
| Purpose | 557 |
| Measurement Method | 557 |
| Baseband I/Q Inputs (Option B7C) Measurement Concepts | 558 |
| What are Baseband I/Q Inputs? | 558 |
| What are Baseband I/Q Signals? | 559 |
| Why Make Measurements at Baseband? | 559 |
| Selecting Input Probes for Baseband Measurements | 559 |
| Baseband I/Q Measurement Views | 562 |
| Other Sources of Measurement Information | 565 |
| Instrument Updates at www.agilent.com | 565 |
| | |
| 6. Menu Maps | |
| EDGE and GSM Measurement Key Flow | 568 |

List of Commands

| | |
|--|-----|
| :CALCulate:CLIMits:FAIL? | 272 |
| :CALCulate:DATA<n>:COMPRESS? BLOCK CFIT MAXimum MINimum MEAN DMEan RMS SAMPLE SDEVIation PPHase [,<soffset>[,<length>[,<roffset>[,<rlimit>]]]] | 272 |
| :CALCulate:DATA<n>:PEAKs? <threshold>,<excursion>[,AMPLitude FREQuency TIME] ... | 282 |
| :CALCulate:DATA[n]? | 272 |
| :CALCulate:EEVM:LIMit:BTS:EXTRemE:EVMP95 <real> | 284 |
| :CALCulate:EEVM:LIMit:BTS:EXTRemE:EVMP95? | 284 |
| :CALCulate:EEVM:LIMit:BTS:EXTRemE:FERRor <real> | 284 |
| :CALCulate:EEVM:LIMit:BTS:EXTRemE:FERRor? | 284 |
| :CALCulate:EEVM:LIMit:BTS:EXTRemE:IQOOffset <float> | 285 |
| :CALCulate:EEVM:LIMit:BTS:EXTRemE:IQOOffset? | 285 |
| :CALCulate:EEVM:LIMit:BTS:EXTRemE:PEVM <real> | 286 |
| :CALCulate:EEVM:LIMit:BTS:EXTRemE:PEVM? | 286 |
| :CALCulate:EEVM:LIMit:BTS:EXTRemE:REVM <real> | 287 |
| :CALCulate:EEVM:LIMit:BTS:EXTRemE:REVM? | 287 |
| :CALCulate:EEVM:LIMit:BTS:NORMal:EVMP95 <real> | 287 |
| :CALCulate:EEVM:LIMit:BTS:NORMal:EVMP95? | 288 |
| :CALCulate:EEVM:LIMit:BTS:NORMal:FERRor <real> | 288 |
| :CALCulate:EEVM:LIMit:BTS:NORMal:FERRor? | 288 |
| :CALCulate:EEVM:LIMit:BTS:NORMal:IQOOffset <float> | 289 |
| :CALCulate:EEVM:LIMit:BTS:NORMal:IQOOffset? | 289 |
| :CALCulate:EEVM:LIMit:BTS:NORMal:PEVM <real> | 290 |
| :CALCulate:EEVM:LIMit:BTS:NORMal:PEVM? | 290 |
| :CALCulate:EEVM:LIMit:BTS:NORMal:REVM <real> | 290 |
| :CALCulate:EEVM:LIMit:BTS:NORMal:REVM? | 290 |
| :CALCulate:EEVM:LIMit:MBTS:EXTRemE:FERRor <real> | 292 |
| :CALCulate:EEVM:LIMit:MBTS:EXTRemE:FERRor? | 292 |
| :CALCulate:EEVM:LIMit:MBTS:NORMal:FERRor <real> | 293 |
| :CALCulate:EEVM:LIMit:MBTS:NORMal:FERRor? | 293 |
| :CALCulate:EEVM:LIMit:MS:EXTRemE:EVMP95 <real> | 291 |
| :CALCulate:EEVM:LIMit:MS:EXTRemE:EVMP95? | 291 |

List of Commands

| | |
|---|-----|
| :CALCulate:EEVM:LIMit:MS:EXTReme:FERRor <real> | 292 |
| :CALCulate:EEVM:LIMit:MS:EXTReme:FERRor? | 292 |
| :CALCulate:EEVM:LIMit:MS:EXTReme:IQOOffset <real> | 293 |
| :CALCulate:EEVM:LIMit:MS:EXTReme:IQOOffset? | 293 |
| :CALCulate:EEVM:LIMit:MS:EXTReme:PEVM <real> | 294 |
| :CALCulate:EEVM:LIMit:MS:EXTReme:PEVM? | 294 |
| :CALCulate:EEVM:LIMit:MS:EXTReme:REVM <real> | 295 |
| :CALCulate:EEVM:LIMit:MS:EXTReme:REVM? | 295 |
| :CALCulate:EEVM:LIMit:MS:NORMal:EVMP95 <real> | 295 |
| :CALCulate:EEVM:LIMit:MS:NORMal:EVMP95? | 295 |
| :CALCulate:EEVM:LIMit:MS:NORMal:FERRor <real> | 296 |
| :CALCulate:EEVM:LIMit:MS:NORMal:FERRor? | 296 |
| :CALCulate:EEVM:LIMit:MS:NORMal:IQOOffset <real> | 296 |
| :CALCulate:EEVM:LIMit:MS:NORMal:IQOOffset? | 296 |
| :CALCulate:EEVM:LIMit:MS:NORMal:PEVM <real> | 297 |
| :CALCulate:EEVM:LIMit:MS:NORMal:PEVM? | 297 |
| :CALCulate:EEVM:LIMit:MS:NORMal:REVM <real> | 297 |
| :CALCulate:EEVM:LIMit:MS:NORMal:REVM? | 297 |
| :CALCulate:EEVM:LIMit:PBTS:EXTReme:FERRor <real> | 298 |
| :CALCulate:EEVM:LIMit:PBTS:EXTReme:FERRor? | 298 |
| :CALCulate:EEVM:LIMit:PBTS:NORMal:FERRor <real> | 299 |
| :CALCulate:EEVM:LIMit:PBTS:NORMal:FERRor? | 299 |
| :CALCulate:ETSPur:LIMit:TEST ABSolute RELative | 300 |
| :CALCulate:ETSPur:LIMit:TEST? | 300 |
| :CALCulate:ETSPur:LIMit[:UPPer][:DATA] <power> | 300 |
| :CALCulate:ETSPur:LIMit[:UPPer][:DATA]? | 300 |
| :CALCulate:PFER:LIMit:BTS:FERRor <real> | 312 |
| :CALCulate:PFER:LIMit:BTS:FERRor? | 312 |
| :CALCulate:PFER:LIMit:BTS:PPHase <degree> | 312 |
| :CALCulate:PFER:LIMit:BTS:PPHase? | 312 |
| :CALCulate:PFER:LIMit:BTS:RPHase <degree> | 313 |

List of Commands

| | |
|--|-----|
| :CALCulate:PFER:LIMit:BTS:RPHase? | 313 |
| :CALCulate:PFER:LIMit:MBTS:FERRor <real> | 313 |
| :CALCulate:PFER:LIMit:MBTS:FERRor? | 314 |
| :CALCulate:PFER:LIMit:MS:FERRor <real>..... | 314 |
| :CALCulate:PFER:LIMit:MS:FERRor?..... | 314 |
| :CALCulate:PFER:LIMit:MS:PPHase <degree>..... | 315 |
| :CALCulate:PFER:LIMit:MS:PPHase? | 315 |
| :CALCulate:PFER:LIMit:MS:RPHase <degree> | 315 |
| :CALCulate:PFER:LIMit:MS:RPHase?..... | 315 |
| :CALCulate:PFER:LIMit:PBTS:FERRor <real>..... | 316 |
| :CALCulate:PFER:LIMit:PBTS:FERRor?..... | 316 |
| :CALCulate:SPEctrum:MARKer[1] 2 3 4:IQ?..... | 316 |
| :CALCulate:TSPur:LIMit:TEST ABSolute RELative | 317 |
| :CALCulate:TSPur:LIMit:TEST?..... | 317 |
| :CALCulate:TSPur:LIMit[:UPPer][:DATA] <power> | 317 |
| :CALCulate:TSPur:LIMit[:UPPer][:DATA]? | 317 |
| :CALCulate:WAVEform:MARKer[1] 2 3 4:IQ? | 317 |
| :CALCulate:<measurement>:MARKer:AOFF | 304 |
| :CALCulate:<measurement>:MARKer[1] 2 3 4:FUNCTion:RESult? | 304 |
| :CALCulate:<measurement>:MARKer[1] 2 3 4:MAXimum | 304 |
| :CALCulate:<measurement>:MARKer[1] 2 3 4:MINimum | 305 |
| :CALCulate:<measurement>:MARKer[1] 2 3 4:MODE POSition DELTA | 305 |
| :CALCulate:<measurement>:MARKer[1] 2 3 4:MODE POSition DELTA RMSDegree RMSRadi- an RFM RMSJitter OFF..... | 305 |
| :CALCulate:<measurement>:MARKer[1] 2 3 4:MODE?..... | 305 |
| :CALCulate:<measurement>:MARKer[1] 2 3 4:TRACe <trace_name>..... | 306 |
| :CALCulate:<measurement>:MARKer[1] 2 3 4:TRACe? | 306 |
| :CALCulate:<measurement>:MARKer[1] 2 3 4:X <param>..... | 310 |
| :CALCulate:<measurement>:MARKer[1] 2 3 4:X:POSition <integer> | 311 |
| :CALCulate:<measurement>:MARKer[1] 2 3 4:X:POSition?..... | 311 |
| :CALCulate:<measurement>:MARKer[1] 2 3 4:X? | 310 |

List of Commands

| | |
|---|-----|
| :CALCulate:<measurement>:MARKer[1] 2 3 4:Y? | 311 |
| :CALCulate:<measurement>:MARKer[1] 2 3 4[:STATe] OFF ON 0 1 | 306 |
| :CALCulate:<measurement>:MARKer[1] 2 3 4[:STATe]? | 306 |
| :CONFigure:AREFERENCE | 352 |
| :CONFigure:EEVM | 353 |
| :CONFigure:EORFspectr | 357 |
| :CONFigure:EPVTime | 361 |
| :CONFigure:ETSPur | 364 |
| :CONFigure:ORFSpectrum | 366 |
| :CONFigure:PFERror | 370 |
| :CONFigure:PVTime | 373 |
| :CONFigure:SENSors | 377 |
| :CONFigure:SPECTrum | 378 |
| :CONFigure:TBFRequency | 381 |
| :CONFigure:TSPur | 382 |
| :CONFigure:TXPower | 383 |
| :CONFigure:WAVeform | 385 |
| :CONFigure:<measurement> | 319 |
| :CONFigure? | 319 |
| :DISPlay:ACP:VIEW BGRaph SPECTrum | 320 |
| :DISPlay:ACP:VIEW? | 320 |
| :DISPlay:EEVM:VIEW[:SElect] POLar CONSTln QUAD DBITs | 323 |
| :DISPlay:EEVM:VIEW[:SElect]? | 323 |
| :DISPlay:ENABLE OFF ON 0 1 | 320 |
| :DISPlay:ENABLE? | 320 |
| :DISPlay:EORFspectr:VIEW[:SElect] MPOWer MLIMit SLIMit | 322 |
| :DISPlay:EORFspectr:VIEW[:SElect]? | 322 |
| :DISPlay:EPVTime:LIMit:MASK OFF ON 0 1 | 321 |
| :DISPlay:EPVTime:LIMit:MASK? | 321 |
| :DISPlay:EPVT:VIEW[:SElect] ALL BOTH MSLot | 321 |
| :DISPlay:EPVT:VIEW[:SElect]? | 321 |

List of Commands

| | |
|--|-----|
| :DISPlay:FORMat:TILE | 327 |
| :DISPlay:FORMat:ZOOM | 327 |
| :DISPlay:FSCReen[:STATe] OFF ON 0 1 | 328 |
| :DISPlay:FSCReen[:STATe]? | 328 |
| :DISPlay:FSCREEN FULLSCREEN[:STATe] ON OFF 1 0 | 328 |
| :DISPlay:FSCREEN FULLSCREEN[:STATe]? | 328 |
| :DISPlay:ORFspectrum:VIEW[:SElect] MPOWer MLIMit SLIMit | 325 |
| :DISPlay:ORFspectrum:VIEW[:SElect]? | 325 |
| :DISPlay:PFERror:VIEW[:SElect] QUAD POLar DBITs | 326 |
| :DISPlay:PFERror:VIEW[:SElect]? | 326 |
| :DISPlay:PVTime:LIMit:MASK OFF ON 0 1 | 328 |
| :DISPlay:PVTime:LIMit:MASK? | 328 |
| :DISPlay:PVT:VIEW[:SElect] ALL BOTH MSLot | 324 |
| :DISPlay:PVT:VIEW[:SElect]? | 324 |
| :DISPlay:SPECtrum[n]:WINDow[m]:TRACe:Y[:SCALe]:PDIVision <power> | 328 |
| :DISPlay:SPECtrum[n]:WINDow[m]:TRACe:Y[:SCALe]:PDIVision? | 329 |
| :DISPlay:SPECtrum[n]:WINDow[m]:TRACe:Y[:SCALe]:RLEVel <power> | 330 |
| :DISPlay:SPECtrum[n]:WINDow[m]:TRACe:Y[:SCALe]:RLEVel? | 330 |
| :DISPlay:TRACe[n][:STATe] OFF ON 0 1 | 331 |
| :DISPlay:TRACe[n][:STATe]? | 331 |
| :DISPlay:WAVeform[n]:WINDow[m]:TRACe:Y[:SCALe]:PDIVision <power> | 335 |
| :DISPlay:WAVeform[n]:WINDow[m]:TRACe:Y[:SCALe]:PDIVision? | 335 |
| :DISPlay:WAVeform[n]:WINDow[m]:TRACe:Y[:SCALe]:RLEVel <power> | 336 |
| :DISPlay:WAVeform[n]:WINDow[m]:TRACe:Y[:SCALe]:RLEVel? | 336 |
| :FETCh:AREFERENCE[n]? | 352 |
| :FETCh:EEVM[n]? | 353 |
| :FETCh:EORFspectr[n]? | 357 |
| :FETCh:EPVTime[n]? | 361 |
| :FETCh:ETSPur[n]? | 364 |
| :FETCh:ORFspectrum[n]? | 366 |
| :FETCh:PFERror[n]? | 370 |

List of Commands

| | |
|--|------|
| :FETCh:PVTime[n]? | .373 |
| :FETCh:SENSors[n]? | .377 |
| :FETCh:SPECtrum[n]? | .378 |
| :FETCh:TBFRequency[n]? | .381 |
| :FETCh:TSPur[n]? | .382 |
| :FETCh:TXPower[n]? | .383 |
| :FETCh:WAVEform[n]? | .385 |
| :FETCh:<measurement>[n]? | .338 |
| :FORMat:BORDER NORMAl SWAPped | .339 |
| :FORMat:BORDER? | .339 |
| :FORMat[:DATA] ASCii REAL,32 REAL,64 | .339 |
| :FORMat[:DATA]? | .339 |
| :FORMat[:TRACe][:DATA] ASCii INTeger,16 INTeger,32 REAL,32 REAL,64 UINteger,16 | .339 |
| :FORMat[:TRACe][:DATA] ASCii REAL[,32] | .339 |
| :FORMat[:TRACe][:DATA]? | .339 |
| :FORMat[:TRACe][:DATA]? | .339 |
| :INITiate:AREFERENCE | .352 |
| :INITiate:CONTinuous OFF ON 0 1 | .341 |
| :INITiate:CONTinuous? | .341 |
| :INITiate:EEVM | .353 |
| :INITiate:EORFSpectr | .357 |
| :INITiate:EPVTime | .361 |
| :INITiate:ETSPur | .364 |
| :INITiate:ORFSpectrum | .366 |
| :INITiate:PFERror? | .370 |
| :INITiate:PVTime | .373 |
| :INITiate:REStart | .342 |
| :INITiate:SENSors | .377 |
| :INITiate:SPECtrum | .378 |
| :INITiate:TBFRequency | .381 |
| :INITiate:TSPur | .382 |

List of Commands

| | |
|--|-----|
| :INITiate:TXPower | 383 |
| :INITiate:WAVeform | 385 |
| :INITiate:<measurement> | 341 |
| :INITiate[:IMMediate] | 342 |
| :INSTrument:CATalog? | 343 |
| :INSTrument:CATalog[:FULL]? | 343 |
| :INSTrument:NSElect <integer> | 343 |
| :INSTrument:NSElect? | 343 |
| :INSTrument[:SElect] BASIC SERVICE CDMA CDMA2K GSM EDGE GSM IDEN NADC PDC WCDMA CDMA1XEV | 344 |
| :INSTrument[:SElect] SA PNOISE BASIC CDMA CDMA2K EDGE GSM NADC PDC WCDMA CDMA1XEV NFIGURE WLAN MRECEIVE | 344 |
| :INSTrument[:SElect]? | 345 |
| :MEASure:AREFERENCE[n]? | 352 |
| :MEASure:EEVM[n]? | 353 |
| :MEASure:EORFspectr[n]? | 357 |
| :MEASure:EPVTime[n]? | 361 |
| :MEASure:ETSPur[n]? | 364 |
| :MEASure:ORFSpectrum[n]? | 366 |
| :MEASure:PFERror[n]? | 370 |
| :MEASure:PVTime[n]? | 373 |
| :MEASure:SENSors[n]? | 377 |
| :MEASure:SPECTrum[n]? | 378 |
| :MEASure:TBFRequency[n]? | 381 |
| :MEASure:TSPur[n]? | 382 |
| :MEASure:TXPower[n]? | 383 |
| :MEASure:WAVeform[n]? | 385 |
| :READ:AREFERENCE[n]? | 352 |
| :READ:EEVM[n]? | 353 |
| :READ:EORFspectr[n]? | 357 |
| :READ:EPVTime[n]? | 361 |
| :READ:ETSPur[n]? | 364 |

List of Commands

| | |
|---|------|
| :READ:ORFSpectrum[n]? | .366 |
| :READ:PFERror[n]? | .370 |
| :READ:PVTime[n]? | .373 |
| :READ:SENSors[n]? | .377 |
| :READ:SPECTrum[n]? | .378 |
| :READ:TBFRequency[n]? | .381 |
| :READ:TSPur[n]? | .382 |
| :READ:TXPower[n]? | .383 |
| :READ:WAVEform[n]? | .385 |
| :READ:<measurement>[n]? | .387 |
| :TRIGger[:SEQuence]:AUTO:STATe OFF ON 0 1 | .514 |
| :TRIGger[:SEQuence]:AUTO:STATe? | .514 |
| :TRIGger[:SEQuence]:AUTO[:TIME] <time> | .514 |
| :TRIGger[:SEQuence]:AUTO[:TIME]? | .514 |
| :TRIGger[:SEQuence]:EXTernal[1] 2:DELAy <time> | .515 |
| :TRIGger[:SEQuence]:EXTernal[1] 2:DELAy? | .515 |
| :TRIGger[:SEQuence]:EXTernal[1] 2:LEVel <voltage> | .515 |
| :TRIGger[:SEQuence]:EXTernal[1] 2:LEVel? | .515 |
| :TRIGger[:SEQuence]:EXTernal[1] 2:SLOPe NEGative POSitive | .515 |
| :TRIGger[:SEQuence]:EXTernal[1] 2:SLOPe? | .516 |
| :TRIGger[:SEQuence]:FRAME:ADJust <time> | .516 |
| :TRIGger[:SEQuence]:FRAME:PERiod <time> | .516 |
| :TRIGger[:SEQuence]:FRAME:PERiod? | .516 |
| :TRIGger[:SEQuence]:FRAME:SYNC EXTFront EXTRear OFF | .517 |
| :TRIGger[:SEQuence]:FRAME:SYNC:OFFSet <time> | .517 |
| :TRIGger[:SEQuence]:FRAME:SYNC:OFFSet? | .517 |
| :TRIGger[:SEQuence]:FRAME:SYNC? | .517 |
| :TRIGger[:SEQuence]:HOLDoff <time> | .518 |
| :TRIGger[:SEQuence]:HOLDoff? | .518 |
| :TRIGger[:SEQuence]:IF:DELAy <time> | .518 |
| :TRIGger[:SEQuence]:IF:DELAy? | .518 |

List of Commands

| | |
|---|-----|
| :TRIGger[:SEQuence]:IF:LEVel <ampl> | 518 |
| :TRIGger[:SEQuence]:IF:LEVel? | 518 |
| :TRIGger[:SEQuence]:IF:SLOPe NEGative POSitive | 519 |
| :TRIGger[:SEQuence]:IF:SLOPe? | 519 |
| :TRIGger[:SEQuence]:RFBurst:DELaY <time> | 519 |
| :TRIGger[:SEQuence]:RFBurst:DELaY? | 519 |
| :TRIGger[:SEQuence]:RFBurst:LEVel <rel_power> | 519 |
| :TRIGger[:SEQuence]:RFBurst:LEVel? | 519 |
| :TRIGger[:SEQuence]:RFBurst:SLOPe NEGative POSitive | 520 |
| :TRIGger[:SEQuence]:RFBurst:SLOPe? | 520 |
| [:SENSe]:CHANnel:ARFCn RFCHannel <integer> | 390 |
| [:SENSe]:CHANnel:ARFCn RFCHannel:BOTTom | 390 |
| [:SENSe]:CHANnel:ARFCn RFCHannel:MIDDLE | 391 |
| [:SENSe]:CHANnel:ARFCn RFCHannel:TOP | 392 |
| [:SENSe]:CHANnel:ARFCn RFCHannel? | 390 |
| [:SENSe]:CHANnel:BURSt NORMal SYNC ACCess | 392 |
| [:SENSe]:CHANnel:BURSt? | 392 |
| [:SENSe]:CHANnel:SLOT <integer> | 393 |
| [:SENSe]:CHANnel:SLOT:AUTO OFF ON 0 1 | 393 |
| [:SENSe]:CHANnel:SLOT:AUTO? | 393 |
| [:SENSe]:CHANnel:SLOT? | 393 |
| [:SENSe]:CHANnel:TSCode <integer> | 394 |
| [:SENSe]:CHANnel:TSCode:AUTO OFF ON 0 1 | 394 |
| [:SENSe]:CHANnel:TSCode:AUTO? | 394 |
| [:SENSe]:CHANnel:TSCode? | 394 |
| [:SENSe]:CORRection:BTS[:RF]:LOSS <rel_power> | 395 |
| [:SENSe]:CORRection:BTS[:RF]:LOSS? | 395 |
| [:SENSe]:CORRection:MS[:RF]:LOSS <rel_power> | 395 |
| [:SENSe]:CORRection:MS[:RF]:LOSS? | 395 |
| [:SENSe]:EEVM:AVERAge:COUNt <integer> | 396 |
| [:SENSe]:EEVM:AVERAge:COUNt? | 396 |

List of Commands

| | |
|---|------|
| [:SENSe]:EEVM:AVERAge:TCONtrol EXPonential REPeat | .396 |
| [:SENSe]:EEVM:AVERAge:TCONtrol? | .396 |
| [:SENSe]:EEVM:AVERAge[:STATe] OFF ON 0 1 | .396 |
| [:SENSe]:EEVM:AVERAge[:STATe]? | .396 |
| [:SENSe]:EEVM:BSYNc:PMODulation:ALIGNment OFF ON 0 1 | .397 |
| [:SENSe]:EEVM:BSYNc:PMODulation:ALIGNment? | .397 |
| [:SENSe]:EEVM:BSYNc:SOURce RFBurst PMODulation TSEQuence NONE | .397 |
| [:SENSe]:EEVM:BSYNc:SOURce? | .397 |
| [:SENSe]:EEVM:DROop OFF ON 0 1 | .398 |
| [:SENSe]:EEVM:DROop? | .398 |
| [:SENSe]:EEVM:ELIMit OFF ON 0 1 | .399 |
| [:SENSe]:EEVM:ELIMit? | .399 |
| [:SENSe]:EEVM:FERRor:TRANge WIDE NORMal | .399 |
| [:SENSe]:EEVM:FERRor:TRANge? | .399 |
| [:SENSe]:EEVM:SDOTs[:STATe] OFF ON 0 1 | .399 |
| [:SENSe]:EEVM:SDOTs[:STATe]? | .399 |
| [:SENSe]:EEVM:TRACe:SDOTs <integer> | .400 |
| [:SENSe]:EEVM:TRACe:SDOTs? | .400 |
| [:SENSe]:EEVM:TRIGger:SOURce EXTernal[1] EXTernal2 FRAMe IF IMMediate RFBurst | .400 |
| [:SENSe]:EEVM:TRIGger:SOURce? | .400 |
| [:SENSe]:EEVM:TYPE:LIMit NORMal EXTReme | .400 |
| [:SENSe]:EEVM:TYPE:LIMit? | .401 |
| [:SENSe]:EORFSpectrum:DETEctor:SWITChing:FAST[:STATe] OFF ON 0 1 | .406 |
| [:SENSe]:EORFSpectrum:DETEctor:SWITChing? | .406 |
| [:SENSe]:EORFSpectr:AVERAge:COUNt <integer> | .402 |
| [:SENSe]:EORFSpectr:AVERAge:COUNt? | .402 |
| [:SENSe]:EORFSpectr:AVERAge:FAST[:STATe] OFF ON 0 1 | .402 |
| [:SENSe]:EORFSpectr:AVERAge:FAST[:STATe]? | .402 |
| [:SENSe]:EORFSpectr:AVERAge:MODulation:TYPE LOG RMS | .403 |
| [:SENSe]:EORFSpectr:AVERAge:MODulation:TYPE? | .403 |
| [:SENSe]:EORFSpectr:AVERAge[:STATe] OFF ON 0 1 | .403 |

List of Commands

| | |
|---|-----|
| [[:SENSE]:EORFspectr:AVERage[:STATE]? | 403 |
| [[:SENSE]:EORFspectr:BANDwidth BWIDth[:RESolution] :MODulation:CARRier <freq> | 403 |
| [[:SENSE]:EORFspectr:BANDwidth BWIDth[:RESolution] :MODulation:CARRier? | 403 |
| [[:SENSE]:EORFspectr:BANDwidth BWIDth[:RESolution] :MODulation:OFFSet:CLOSe <freq> | 404 |
| [[:SENSE]:EORFspectr:BANDwidth BWIDth[:RESolution] :MODulation:OFFSet:CLOSe? | 404 |
| [[:SENSE]:EORFspectr:BANDwidth BWIDth[:RESolution] :MODulation:OFFSet:FAR <freq> | 404 |
| [[:SENSE]:EORFspectr:BANDwidth BWIDth[:RESolution] :MODulation:OFFSet:FAR? | 404 |
| [[:SENSE]:EORFspectr:BANDwidth BWIDth[:RESolution] :SWITching:CARRier <freq> | 405 |
| [[:SENSE]:EORFspectr:BANDwidth BWIDth[:RESolution] :SWITching:CARRier? | 405 |
| [[:SENSE]:EORFspectr:BANDwidth BWIDth[:RESolution] :SWITching:OFFSet:CLOSe <freq> | 405 |
| [[:SENSE]:EORFspectr:BANDwidth BWIDth[:RESolution] :SWITching:OFFSet:CLOSe? | 405 |
| [[:SENSE]:EORFspectr:BANDwidth BWIDth[:RESolution] :SWITching:OFFSet:FAR <freq> | 405 |
| [[:SENSE]:EORFspectr:BANDwidth BWIDth[:RESolution] :SWITching:OFFSet:FAR? | 406 |
| [[:SENSE]:EORFspectr:BFRequency <freq> | 406 |
| [[:SENSE]:EORFspectr:BFRequency? | 406 |
| [[:SENSE]:EORFspectr:LIST:MODulation:APPLy RELative BOTH ABSolute{,RELative BOTH ABSolute} | 407 |
| [[:SENSE]:EORFspectr:LIST:MODulation:APPLy? | 407 |
| [[:SENSE]:EORFspectr:LIST:MODulation:BANDwidth BWIDth <res bw>{,<res bw>} | 408 |
| [[:SENSE]:EORFspectr:LIST:MODulation:BANDwidth BWIDth? | 408 |
| [[:SENSE]:EORFspectr:LIST:MODulation:LOFFset [:RCARrier]<level>{,<level>} | 410 |
| [[:SENSE]:EORFspectr:LIST:MODulation:LOFFset [:RCARrier]? | 410 |
| [[:SENSE]:EORFspectr:LIST:MODulation:LOFFset:ABSolute <level>{,<level>} | 409 |

List of Commands

| | |
|---|-----|
| [:SENSe]:EORFspectr:LIST:MODulation:LOFFset:ABSolute? | 409 |
| [:SENSe]:EORFspectr:LIST:MODulation:STATe OFF ON 0 1{,OFF ON 0 1}..... | 409 |
| [:SENSe]:EORFspectr:LIST:MODulation:STATe? | 409 |
| [:SENSe]:EORFspectr:LIST:MODulation[:FREQuency] <offset freq>{,<offset freq>} | 408 |
| [:SENSe]:EORFspectr:LIST:MODulation[:FREQuency]? | 408 |
| [:SENSe]:EORFspectr:LIST:SElect CUSTom SHORT STANdard | 411 |
| [:SENSe]:EORFspectr:LIST:SElect? | 411 |
| [:SENSe]:EORFspectr:LIST:SWITching:APPLy RELative BOTH ABSolute{,RELative BOTH ABSolute} | 412 |
| [:SENSe]:EORFspectr:LIST:SWITching:APPLy? | 412 |
| [:SENSe]:EORFspectr:LIST:SWITching:BANDwidth BWIDTH <res bw>{,<res bw>} | 414 |
| [:SENSe]:EORFspectr:LIST:SWITching:BANDwidth BWIDTH? | 414 |
| [:SENSe]:EORFspectr:LIST:SWITching:LOFFset [:RCARrier] <level>{,<level>} | 415 |
| [:SENSe]:EORFspectr:LIST:SWITching:LOFFset [:RCARrier]? | 415 |
| [:SENSe]:EORFspectr:LIST:SWITching:LOFFset:ABSolute <level>{,<level>} | 412 |
| [:SENSe]:EORFspectr:LIST:SWITching:LOFFset:ABSolute? | 412 |
| [:SENSe]:EORFspectr:LIST:SWITching:STATe OFF ON 0 1{,OFF ON 0 1} | 413 |
| [:SENSe]:EORFspectr:LIST:SWITching:STATe? | 413 |
| [:SENSe]:EORFspectr:LIST:SWITching[:FREQuency] <offset freq>{,<offset freq>} | 413 |
| [:SENSe]:EORFspectr:LIST:SWITching[:FREQuency] <offset freq>{,<offset freq>} | 414 |
| [:SENSe]:EORFspectr:LIST:SWITching[:FREQuency]? | 413 |
| [:SENSe]:EORFspectr:LIST:SWITching[:FREQuency]? | 415 |
| [:SENSe]:EORFspectr:MEASure MULTiple SINGLE SWEPT | 407 |
| [:SENSe]:EORFspectr:MEASure MULTiple SINGLE SWEPT | 416 |
| [:SENSe]:EORFspectr:MEASure? | 407 |
| [:SENSe]:EORFspectr:MEASure? | 416 |
| [:SENSe]:EORFspectr:OFRequency <freq> | 416 |
| [:SENSe]:EORFspectr:OFRequency? | 416 |
| [:SENSe]:EORFspectr:TRIGger:SOURce EXTernal[1] EXTernal2 FRAMe IMMEDIATE RFBurst | 416 |
| [:SENSe]:EORFspectr:TRIGger:SOURce? | 416 |

List of Commands

| | |
|--|-----|
| [[:SENSe]:EORFspectr:TYPE MODulation MSWitching SWITching FFModulation | 417 |
| [[:SENSe]:EORFspectr:TYPE:MODulation[:METHod] DIScrete SWEep | 417 |
| [[:SENSe]:EORFspectr:TYPE:MODulation[:METHod]? | 418 |
| [[:SENSe]:EORFspectr:TYPE? | 417 |
| [[:SENSe]:EPVTime:AVERAge:COUNt <integer> | 419 |
| [[:SENSe]:EPVTime:AVERAge:COUNt? | 419 |
| [[:SENSe]:EPVTime:AVERAge:TCONtrol EXPonential REPeat | 419 |
| [[:SENSe]:EPVTime:AVERAge:TCONtrol? | 419 |
| [[:SENSe]:EPVTime:AVERAge:TYPE LOG MAXimum MINimum MXMinimum RMS | 420 |
| [[:SENSe]:EPVTime:AVERAge:TYPE? | 420 |
| [[:SENSe]:EPVTime:AVERAge[:STATe] OFF ON 0 1 | 419 |
| [[:SENSe]:EPVTime:AVERAge[:STATe]? | 419 |
| [[:SENSe]:EPVTime:BANDwidth BWIDth[:RESolution] <freq> | 420 |
| [[:SENSe]:EPVTime:BANDwidth BWIDth[:RESolution]:TYPE FLATtop GAUSSian | 421 |
| [[:SENSe]:EPVTime:BANDwidth BWIDth[:RESolution]:TYPE? | 421 |
| [[:SENSe]:EPVTime:BANDwidth BWIDth[:RESolution]? | 420 |
| [[:SENSe]:EPVTime:BSYNc:SLENgth EVEN INTeger | 421 |
| [[:SENSe]:EPVTime:BSYNc:SLENgth? | 421 |
| [[:SENSe]:EPVTime:BSYNc:SOURce TSEQuence RFBurst NONE | 421 |
| [[:SENSe]:EPVTime:BSYNc:SOURce? | 421 |
| [[:SENSe]:EPVTime:LIMit:MASK OFF ON 0 1 | 422 |
| [[:SENSe]:EPVTime:LIMit:MASK? | 422 |
| [[:SENSe]:EPVTime:MASK:LIST:LOWer:ABSolute <power>,<power>,<power>,<power>,<power>, | 423 |
| [[:SENSe]:EPVTime:MASK:LIST:LOWer:ABSolute? | 423 |
| [[:SENSe]:EPVTime:MASK:LIST:LOWer:POINts? | 423 |
| [[:SENSe]:EPVTime:MASK:LIST:LOWer:RELative <rel_power>,<rel_power>,<rel_power>,<rel_power>,<rel_power>, | 424 |
| [[:SENSe]:EPVTime:MASK:LIST:LOWer:RELative? | 424 |
| [[:SENSe]:EPVTime:MASK:LIST:LOWer:TIME <seconds>,<seconds>,<seconds>,<seconds>,<seconds>, | 424 |
| [[:SENSe]:EPVTime:MASK:LIST:LOWer:TIME? | 424 |

List of Commands

| | |
|---|-----|
| [[:SENSe]:FREQUency:CENTer <freq> | 437 |
| [[:SENSe]:FREQUency:CENTer:STEP[:INCRement] <freq> | 437 |
| [[:SENSe]:FREQUency:CENTer:STEP[:INCRement]? | 437 |
| [[:SENSe]:FREQUency:CENTer? | 437 |
| [[:SENSe]:ORFSpectrum:AVERAge:COUNT <integer> | 439 |
| [[:SENSe]:ORFSpectrum:AVERAge:COUNT? | 439 |
| [[:SENSe]:ORFSpectrum:AVERAge:FAST[:STATe] OFF ON 0 1 | 439 |
| [[:SENSe]:ORFSpectrum:AVERAge:FAST[:STATe]? | 439 |
| [[:SENSe]:ORFSpectrum:AVERAge:MODulation:TYPE LOG RMS | 440 |
| [[:SENSe]:ORFSpectrum:AVERAge:MODulation:TYPE? | 440 |
| [[:SENSe]:ORFSpectrum:AVERAge:SWITChing:TYPE? | 440 |
| [[:SENSe]:ORFSpectrum:AVERAge[:STATe] OFF ON 0 1 | 440 |
| [[:SENSe]:ORFSpectrum:AVERAge[:STATe]? | 440 |
| [[:SENSe]:ORFSpectrum: BANDwidth BWIDth[:RESolution] :MODulation:CARRier <freq> | 441 |
| [[:SENSe]:ORFSpectrum: BANDwidth BWIDth[:RESolution] :MODulation:CARRier? | 441 |
| [[:SENSe]:ORFSpectrum: BANDwidth BWIDth[:RESolution] :MODulation:OFFSet:CLOSe <freq> | 441 |
| [[:SENSe]:ORFSpectrum: BANDwidth BWIDth[:RESolution] :MODulation:OFFSet:CLOSe? | 441 |
| [[:SENSe]:ORFSpectrum: BANDwidth BWIDth[:RESolution] :MODulation:OFFSet:FAR <freq> | 441 |
| [[:SENSe]:ORFSpectrum: BANDwidth BWIDth[:RESolution] :MODulation:OFFSet:FAR? | 442 |
| [[:SENSe]:ORFSpectrum: BANDwidth BWIDth[:RESolution] :SWITChing:CARRier <freq> | 442 |
| [[:SENSe]:ORFSpectrum: BANDwidth BWIDth[:RESolution] :SWITChing:CARRier? | 442 |
| [[:SENSe]:ORFSpectrum: BANDwidth BWIDth[:RESolution] :SWITChing:OFFSet:CLOSe <freq> | 442 |
| [[:SENSe]:ORFSpectrum: BANDwidth BWIDth[:RESolution] :SWITChing:OFFSet:CLOSe? | 442 |
| [[:SENSe]:ORFSpectrum: BANDwidth BWIDth[:RESolution] :SWITChing:OFFSet:FAR <freq> | 443 |

List of Commands

| | |
|---|-----|
| [[:SENSe]:ORFSpectrum:BA ^N Dwidth BWIDth[:RE ^S olution] :SWITChing:OFFSet:FAR? | 443 |
| [[:SENSe]:ORFSpectrum:BF ^R equency <freq> | 443 |
| [[:SENSe]:ORFSpectrum:BF ^R equency? | 443 |
| [[:SENSe]:ORFSpectrum:DE ^T ector:SWITChing:FAST[:STATe] OFF ON 0 1 | 444 |
| [[:SENSe]:ORFSpectrum:DE ^T ector:SWITChing? | 444 |
| [[:SENSe]:ORFSpectrum:LIST:MODulation:APPLY RELative BOTH ABSolute{,RELa- tive BOTH ABSolute} | 438 |
| [[:SENSe]:ORFSpectrum:LIST:MODulation:APPLY? | 438 |
| [[:SENSe]:ORFSpectrum:LIST:MODulation:BA ^N Dwidth BWIDth <res bw>{,<res bw>} | 444 |
| [[:SENSe]:ORFSpectrum:LIST:MODulation:BA ^N Dwidth BWIDth? | 444 |
| [[:SENSe]:ORFSpectrum:LIST:MODulation:LOFFset:ABSolute <level>{,<level>} | 446 |
| [[:SENSe]:ORFSpectrum:LIST:MODulation:LOFFset:ABSolute? | 446 |
| [[:SENSe]:ORFSpectrum:LIST:MODulation:LOFFset[:RCARrier] <level>{,<level>} | 445 |
| [[:SENSe]:ORFSpectrum:LIST:MODulation:LOFFset[:RCARrier]? | 445 |
| [[:SENSe]:ORFSpectrum:LIST:MODulation:STATe OFF ON 0 1{,OFF ON 0 1} | 446 |
| [[:SENSe]:ORFSpectrum:LIST:MODulation:STATe? | 446 |
| [[:SENSe]:ORFSpectrum:LIST:MODulation[:FRE ^Q uency] <offset freq>{,<offset freq>} | 446 |
| [[:SENSe]:ORFSpectrum:LIST:MODulation[:FRE ^Q uency]? | 446 |
| [[:SENSe]:ORFSpectrum:LIST:SE ^L ect CUS ^T om SHORt STANdard | 447 |
| [[:SENSe]:ORFSpectrum:LIST:SE ^L ect? | 447 |
| [[:SENSe]:ORFSpectrum:LIST:SWITChing:APPLY <RELative BOTH ABSolute>{,<RELative BOTH ABSolute>} | 448 |
| [[:SENSe]:ORFSpectrum:LIST:SWITChing:APPLY? | 448 |
| [[:SENSe]:ORFSpectrum:LIST:SWITChing:BA ^N Dwidth BWIDth <res_bw>{,<res_bw>} | 449 |
| [[:SENSe]:ORFSpectrum:LIST:SWITChing:BA ^N Dwidth BWIDth? | 449 |
| [[:SENSe]:ORFSpectrum:LIST:SWITChing:LOFFset:ABSolute <level>{,<level>} | 450 |
| [[:SENSe]:ORFSpectrum:LIST:SWITChing:LOFFset:ABSolute? | 450 |
| [[:SENSe]:ORFSpectrum:LIST:SWITChing:LOFFset[:RCARrier] <level>{,<level>} | 449 |
| [[:SENSe]:ORFSpectrum:LIST:SWITChing:LOFFset[:RCARrier]? | 449 |

List of Commands

| | |
|--|-----|
| [[:SENSE]:ORFSpectrum:LIST:SWITChing:STATe OFF ON 0 1]{,OFF ON 0 1} | 451 |
| [[:SENSE]:ORFSpectrum:LIST:SWITChing:STATe? | 451 |
| [[:SENSE]:ORFSpectrum:LIST:SWITChing[:FREQuency] <offset freq>{,<offset freq>} | 451 |
| [[:SENSE]:ORFSpectrum:LIST:SWITChing[:FREQuency]? | 451 |
| [[:SENSE]:ORFSpectrum:MEASure MULTiple SINGLE SWEPT. | 452 |
| [[:SENSE]:ORFSpectrum:MEASure? | 452 |
| [[:SENSE]:ORFSpectrum:MEASure? | 452 |
| [[:SENSE]:ORFSpectrum:OFRequency <freq>. | 453 |
| [[:SENSE]:ORFSpectrum:OFRequency? | 453 |
| [[:SENSE]:ORFSpectrum:TRIGger:SOURce EXTernal[1] EXTernal2 FRAME IMMEDIATE RFBurst | 453 |
| [[:SENSE]:ORFSpectrum:TRIGger:SOURce? | 453 |
| [[:SENSE]:ORFSpectrum:TYPE MODulation MSWitching SWITChing FFModulation | 454 |
| [[:SENSE]:ORFSpectrum:TYPE? | 454 |
| [[:SENSE]:PFERror:AVERage:COUNT <integer>. | 455 |
| [[:SENSE]:PFERror:AVERage:COUNT? | 455 |
| [[:SENSE]:PFERror:AVERage:TCONtrol EXPonential REPeat. | 455 |
| [[:SENSE]:PFERror:AVERage:TCONtrol? | 455 |
| [[:SENSE]:PFERror:AVERage:TYPE MEAN MAXimum | 456 |
| [[:SENSE]:PFERror:AVERage:TYPE? | 456 |
| [[:SENSE]:PFERror:AVERage[:STATe] OFF ON 0 1 | 455 |
| [[:SENSE]:PFERror:AVERage[:STATe]? | 455 |
| [[:SENSE]:PFERror:BSYNc:SOURce EXTernal[1] EXTernal2 NONE RFBurst TSEQUence. | 456 |
| [[:SENSE]:PFERror:BSYNc:SOURce? | 456 |
| [[:SENSE]:PFERror:IQOFFset[:STATe] OFF ON 0 1. | 456 |
| [[:SENSE]:PFERror:IQOFFset[:STATe]? | 456 |
| [[:SENSE]:PFERror:TRACe[:STATe] OFF ON 0 1 | 457 |
| [[:SENSE]:PFERror:TRACe[:STATe]? | 457 |
| [[:SENSE]:PFERror:TRIGger:SOURce EXTernal[1] EXTernal2 FRAME IF IMMEDIATE RFBurst | 457 |
| [[:SENSE]:PFERror:TRIGger:SOURce? | 457 |
| [[:SENSE]:POWER:IQ:RANGe[:UPPer] <Float 64>{DBM} DBMV W | 458 |

List of Commands

| | |
|---|-----|
| <code>[:SENSe]:POWer:IQ:RANGe[:UPPer] <power> [DBM] DBMV W</code> | 388 |
| <code>[:SENSe]:POWer:IQ:RANGe[:UPPer]?</code> | 388 |
| <code>[:SENSe]:POWer:IQ:RANGe[:UPPer]?</code> | 458 |
| <code>[:SENSe]:POWer[:RF]:ATTenuation <rel_power></code> | 459 |
| <code>[:SENSe]:POWer[:RF]:ATTenuation?</code> | 459 |
| <code>[:SENSe]:POWer[:RF]:GAIN[:STATe] ON OFF</code> | 459 |
| <code>[:SENSe]:POWer[:RF]:GAIN[:STATe]?</code> | 459 |
| <code>[:SENSe]:POWer[:RF]:RANGe:AUTO OFF ON 0 1</code> | 460 |
| <code>[:SENSe]:POWer[:RF]:RANGe:AUTO?</code> | 460 |
| <code>[:SENSe]:POWer[:RF]:RANGe[:UPPer] <power></code> | 460 |
| <code>[:SENSe]:POWer[:RF]:RANGe[:UPPer]?</code> | 460 |
| <code>[:SENSe]:PVTime:AVERage:COUNT <integer></code> | 462 |
| <code>[:SENSe]:PVTime:AVERage:COUNT?</code> | 462 |
| <code>[:SENSe]:PVTime:AVERage:TCONtrol EXPonential REPEAT</code> | 463 |
| <code>[:SENSe]:PVTime:AVERage:TCONtrol?</code> | 463 |
| <code>[:SENSe]:PVTime:AVERage:TYPE LOG MAXimum MINimum MXMinimum RMS</code> | 463 |
| <code>[:SENSe]:PVTime:AVERage:TYPE LOG MAXimum MINimum MXMinimum RMS POWer</code> | 463 |
| <code>[:SENSe]:PVTime:AVERage:TYPE LOG MAXimum MINimum RMS SCALar</code> | 463 |
| <code>[:SENSe]:PVTime:AVERage:TYPE RMS MAXimum MINimum</code> | 463 |
| <code>[:SENSe]:PVTime:AVERage:TYPE?</code> | 463 |
| <code>[:SENSe]:PVTime:AVERage[:STATe] OFF ON 0 1</code> | 462 |
| <code>[:SENSe]:PVTime:AVERage[:STATe]?</code> | 462 |
| <code>[:SENSe]:PVTime:BANDwidth BWIDth[:RESolution] <freq></code> | 464 |
| <code>[:SENSe]:PVTime:BANDwidth BWIDth[:RESolution]:TYPE FLATtop GAUSSian</code> | 465 |
| <code>[:SENSe]:PVTime:BANDwidth BWIDth[:RESolution]:TYPE?</code> | 465 |
| <code>[:SENSe]:PVTime:BANDwidth BWIDth[:RESolution]?</code> | 464 |
| <code>[:SENSe]:PVTime:BSYNc:SLENgth EVEN INTeger</code> | 465 |
| <code>[:SENSe]:PVTime:BSYNc:SLENgth?</code> | 465 |
| <code>[:SENSe]:PVTime:BSYNc:SOURce TSEQUence RFBurst NONE</code> | 466 |
| <code>[:SENSe]:PVTime:BSYNc:SOURce?</code> | 466 |
| <code>[:SENSe]:PVTime:LIMit:MASK OFF ON 0 1</code> | 467 |

List of Commands

| | |
|--|-----|
| [::SENSe]:PVTime:LIMit:MASK? | 467 |
| [::SENSe]:PVTime:MASK:LIST:LOWer:ABSolute <power>,<power>,<power>,<power>,<power>,.... | 467 |
| [::SENSe]:PVTime:MASK:LIST:LOWer:ABSolute? | 467 |
| [::SENSe]:PVTime:MASK:LIST:LOWer:POINts? | 468 |
| [::SENSe]:PVTime:MASK:LIST:LOWer:RELative <rel_power>,<rel_power>,<rel_power>,<rel_power>,<rel_power>,.... | 468 |
| [::SENSe]:PVTime:MASK:LIST:LOWer:RELative? | 468 |
| [::SENSe]:PVTime:MASK:LIST:LOWer:TIME <seconds>{,<seconds>} | 469 |
| [::SENSe]:PVTime:MASK:LIST:LOWer:TIME? | 469 |
| [::SENSe]:PVTime:MASK:LIST:UPPer:ABSolute <power>,<power>,<power>,<power>,<power>,.... | 470 |
| [::SENSe]:PVTime:MASK:LIST:UPPer:ABSolute? | 470 |
| [::SENSe]:PVTime:MASK:LIST:UPPer:POINts? | 470 |
| [::SENSe]:PVTime:MASK:LIST:UPPer:RELative <rel_power>, <rel_power>,<rel_power>,<rel_power>,<rel_power>,.... | 471 |
| [::SENSe]:PVTime:MASK:LIST:UPPer:RELative? | 471 |
| [::SENSe]:PVTime:MASK:LIST:UPPer:TIME <seconds>,<seconds>,<seconds>,<seconds>,<seconds>,.... | 472 |
| [::SENSe]:PVTime:MASK:LIST:UPPer:TIME? | 472 |
| [::SENSe]:PVTime:MASK:SElect STANdard CUSTom | 473 |
| [::SENSe]:PVTime:MASK:SElect? | 473 |
| [::SENSe]:PVTime:PCLevel <integer> | 475 |
| [::SENSe]:PVTime:PCLevel? | 475 |
| [::SENSe]:PVTime:SWEep:TIME <integer> | 476 |
| [::SENSe]:PVTime:SWEep:TIME? | 476 |
| [::SENSe]:PVTime:TRIGger:SOURce EXTernal[1] EXTernal2 FRAMe IF IMMEdiate RFBurst | 476 |
| [::SENSe]:PVTime:TRIGger:SOURce? | 476 |
| [::SENSe]:RADio:CARRier:HOP OFF ON 0 1 | 478 |
| [::SENSe]:RADio:CARRier:HOP? | 478 |
| [::SENSe]:RADio:CARRier:NUMBer SINGle MULTiple | 478 |
| [::SENSe]:RADio:CARRier:NUMBer? | 478 |

List of Commands

| | |
|--|------|
| [:SENSe]:RADio:CARRier[:TYPE] BURSt CONTinuous | .479 |
| [:SENSe]:RADio:CARRier[:TYPE]? | .479 |
| [:SENSe]:RADio:DEVice BTS MS | .479 |
| [:SENSe]:RADio:DEVice:BASE[:TYPE] NORMAl MICRo MICR1 MICR2 MICR3 PICO | .479 |
| [:SENSe]:RADio:DEVice:BASE[:TYPE]? | .479 |
| [:SENSe]:RADio:DEVice? | .479 |
| [:SENSe]:RADio:STANdard:BAND PGSM EGSM RGSM DCS1800 PCS1900 GSM450 GSM480 GSM700 GSM850 | .480 |
| [:SENSe]:RADio:STANdard:BAND? | .480 |
| [:SENSe]:ROSCillator:EXTernal:FREQuency <frequency> | .482 |
| [:SENSe]:ROSCillator:EXTernal:FREQuency? | .482 |
| [:SENSe]:ROSCillator:OUTPut? | .482 |
| [:SENSe]:ROSCillator:OUTPut[:STATe] OFF ON 0 1 | .482 |
| [:SENSe]:ROSCillator:SOURce INTernal EXTernal | .482 |
| [:SENSe]:ROSCillator:SOURce? | .482 |
| [:SENSe]:SPECTrum:ACQuisition:PACKing AUTO LONG MEDIum SHORT | .484 |
| [:SENSe]:SPECTrum:ACQuisition:PACKing? | .484 |
| [:SENSe]:SPECTrum:ADC:DITHer[:STATe] AUTO ON OFF 2 1 0 | .484 |
| [:SENSe]:SPECTrum:ADC:DITHer[:STATe]? | .484 |
| [:SENSe]:SPECTrum:ADC:RANGe AUTO APEak APLock M6 P0 P6 P12 P18 P24 | .485 |
| [:SENSe]:SPECTrum:ADC:RANGe AUTO APEak APLock NONE P0 P6 P12 P18 | .485 |
| [:SENSe]:SPECTrum:ADC:RANGe? | .485 |
| [:SENSe]:SPECTrum:AVERage:CLEar | .486 |
| [:SENSe]:SPECTrum:AVERage:COUNT <integer> | .486 |
| [:SENSe]:SPECTrum:AVERage:COUNT? | .486 |
| [:SENSe]:SPECTrum:AVERage:TCONtrol EXPonential REPeat | .487 |
| [:SENSe]:SPECTrum:AVERage:TCONtrol? | .487 |
| [:SENSe]:SPECTrum:AVERage:TYPE LOG MAXimum MINimum RMS SCALar | .487 |
| [:SENSe]:SPECTrum:AVERage:TYPE? | .487 |
| [:SENSe]:SPECTrum:AVERage[:STATe] OFF ON 0 1 | .487 |
| [:SENSe]:SPECTrum:AVERage[:STATe]? | .487 |

List of Commands

| | |
|---|-----|
| [[:SENSe]:SPECTrum: BANDwidth BWIDth:IF:AUTO OFF ON 0 1 | 488 |
| [[:SENSe]:SPECTrum: BANDwidth BWIDth:IF:AUTO? | 488 |
| [[:SENSe]:SPECTrum: BANDwidth BWIDth:IF:FLATness OFF ON 0 1 | 489 |
| [[:SENSe]:SPECTrum: BANDwidth BWIDth:IF:FLATness? | 489 |
| [[:SENSe]:SPECTrum: BANDwidth BWIDth:PADC OFF ON 0 1 | 489 |
| [[:SENSe]:SPECTrum: BANDwidth BWIDth:PADC? | 489 |
| [[:SENSe]:SPECTrum: BANDwidth BWIDth:PPFT:TYPE FLAT GAUSSian | 490 |
| [[:SENSe]:SPECTrum: BANDwidth BWIDth:PPFT:TYPE? | 490 |
| [[:SENSe]:SPECTrum: BANDwidth BWIDth:PPFT[:SIZE] <freq> | 489 |
| [[:SENSe]:SPECTrum: BANDwidth BWIDth:PPFT[:SIZE]? | 489 |
| [[:SENSe]:SPECTrum: BANDwidth BWIDth[:RESolution] <freq> | 490 |
| [[:SENSe]:SPECTrum: BANDwidth BWIDth[:RESolution]:AUTO OFF ON 0 1 | 491 |
| [[:SENSe]:SPECTrum: BANDwidth BWIDth[:RESolution]:AUTO? | 491 |
| [[:SENSe]:SPECTrum: BANDwidth BWIDth[:RESolution]? | 490 |
| [[:SENSe]:SPECTrum: DECimate[:FACTor] <integer> | 491 |
| [[:SENSe]:SPECTrum: DECimate[:FACTor]? | 491 |
| [[:SENSe]:SPECTrum: FFT:LENGth <integer> | 492 |
| [[:SENSe]:SPECTrum: FFT:LENGth:AUTO OFF ON 0 1 | 493 |
| [[:SENSe]:SPECTrum: FFT:LENGth:AUTO? | 493 |
| [[:SENSe]:SPECTrum: FFT:LENGth? | 492 |
| [[:SENSe]:SPECTrum: FFT:RBWPoints <real> | 493 |
| [[:SENSe]:SPECTrum: FFT:RBWPoints? | 493 |
| [[:SENSe]:SPECTrum: FFT:WINDow:DELay <real> | 494 |
| [[:SENSe]:SPECTrum: FFT:WINDow:DELay? | 494 |
| [[:SENSe]:SPECTrum: FFT:WINDow:LENGth <integer> | 494 |
| [[:SENSe]:SPECTrum: FFT:WINDow:LENGth? | 494 |
| [[:SENSe]:SPECTrum: FFT:WINDow[:TYPE] BH4Tap BLACKman FLATtop GAUSSian HAM- Ming HANNing KB70 KB90 KB110 UNIFORM | 494 |
| [[:SENSe]:SPECTrum: FFT:WINDow[:TYPE]? | 495 |
| [[:SENSe]:SPECTrum: FREQuency:SPAN <freq> | 495 |
| [[:SENSe]:SPECTrum: FREQuency:SPAN? | 495 |

List of Commands

| | |
|---|------|
| [:SENSe]:SPEcTrum:SWEEp:TIME:AUTO OFF ON 0 1 | .496 |
| [:SENSe]:SPEcTrum:SWEEp:TIME:AUTO | .496 |
| [:SENSe]:SPEcTrum:SWEEp:TIME? | .496 |
| [:SENSe]:SPEcTrum:SWEEp:TIME[:VALue] <time> | .496 |
| [:SENSe]:SPEcTrum:TRIGger:SOURce EXTernal[1] EXTernal2 FRAME IF LINE IMMEDIATE RFBurst | .497 |
| [:SENSe]:SPEcTrum:TRIGger:SOURce? | .497 |
| [:SENSe]:SYNC:ALIGnment GSM HBIT | .498 |
| [:SENSe]:SYNC:ALIGnment? | .498 |
| [:SENSe]:SYNC:BURSt:RFAMplitude:DELay <time> | .498 |
| [:SENSe]:SYNC:BURSt:RFAMplitude:DELay? | .498 |
| [:SENSe]:SYNC:BURSt:STHReshold <rel_power> | .498 |
| [:SENSe]:SYNC:BURSt:STHReshold? | .498 |
| [:SENSe]:TSPur:AVERAge:COUNt <integer> | .499 |
| [:SENSe]:TSPur:AVERAge:COUNt? | .499 |
| [:SENSe]:TSPur:AVERAge:TCONtrol EXPonential REPeat | .500 |
| [:SENSe]:TSPur:AVERAge:TCONtrol? | .500 |
| [:SENSe]:TSPur:AVERAge:TYPE LOG MAXimum RMS | .500 |
| [:SENSe]:TSPur:AVERAge:TYPE? | .500 |
| [:SENSe]:TSPur:AVERAge[:STATe] OFF ON 0 1 | .499 |
| [:SENSe]:TSPur:AVERAge[:STATe]? | .500 |
| [:SENSe]:TSPur:TYPE EXAMine FULL | .501 |
| [:SENSe]:TSPur:TYPE? | .501 |
| [:SENSe]:TXPower:AVERAge:COUNt <integer> | .502 |
| [:SENSe]:TXPower:AVERAge:COUNt? | .502 |
| [:SENSe]:TXPower:AVERAge:TCONtrol EXPonential REPeat | .502 |
| [:SENSe]:TXPower:AVERAge:TCONtrol? | .502 |
| [:SENSe]:TXPower:AVERAge:TYPE LOG MAX MIN RMS | .503 |
| [:SENSe]:TXPower:AVERAge:TYPE? | .503 |
| [:SENSe]:TXPower:AVERAge[:STATe] OFF ON 0 1 | .502 |
| [:SENSe]:TXPower:AVERAge[:STATe]? | .502 |

List of Commands

| | |
|--|-----|
| [[:SENSe]:TXPower:BANDwidth BWIDth[:RESolution] <freq> | 503 |
| [[:SENSe]:TXPower:BANDwidth BWIDth[:RESolution]:TYPE FLAT GAUSSian | 503 |
| [[:SENSe]:TXPower:BANDwidth BWIDth[:RESolution]:TYPE? | 503 |
| [[:SENSe]:TXPower:BANDwidth BWIDth[:RESolution]? | 503 |
| [[:SENSe]:TXPower:SWEep:TIME <integer> | 504 |
| [[:SENSe]:TXPower:SWEep:TIME? | 504 |
| [[:SENSe]:TXPower:THReshold <power>. | 504 |
| [[:SENSe]:TXPower:THReshold:TYPE ABSolute RELative | 505 |
| [[:SENSe]:TXPower:THReshold:TYPE? | 505 |
| [[:SENSe]:TXPower:THReshold?. | 504 |
| [[:SENSe]:TXPower:TRIGger:SOURce EXTernal[1] EXTernal2 IF IMMEDIATE RFBurst | 505 |
| [[:SENSe]:TXPower:TRIGger:SOURce? | 505 |
| [[:SENSe]:VOLTage:IQ:RANGe[:UPPer] <level>. | 388 |
| [[:SENSe]:VOLTage:IQ:RANGe[:UPPer]<Float 64> [V] | 458 |
| [[:SENSe]:VOLTage:IQ:RANGe[:UPPer]? | 389 |
| [[:SENSe]:VOLTage:IQ:RANGe[:UPPer]? | 458 |
| [[:SENSe]:WAVeform:ACQuisition:PACKing AUTO LONG MEDium SHORt. | 506 |
| [[:SENSe]:WAVeform:ACQuisition:PACKing? | 506 |
| [[:SENSe]:WAVeform:ADC:DITHer[:STATe] AUTO ON OFF 2 1 0. | 506 |
| [[:SENSe]:WAVeform:ADC:DITHer[:STATe]? | 506 |
| [[:SENSe]:WAVeform:ADC:FILTer[:STATe] OFF ON 0 1 | 507 |
| [[:SENSe]:WAVeform:ADC:FILTer[:STATe]? | 507 |
| [[:SENSe]:WAVeform:ADC:RANGe AUTO APEak APLock GROund M6 P0 P6 P12 P18 P24. | 507 |
| [[:SENSe]:WAVeform:ADC:RANGe AUTO APEak APLock GROund NONE P0 P6 P12 P18 | 507 |
| [[:SENSe]:WAVeform:ADC:RANGe? | 507 |
| [[:SENSe]:WAVeform:APERture? | 508 |
| [[:SENSe]:WAVeform:AVERage:COUNT <integer> | 508 |
| [[:SENSe]:WAVeform:AVERage:COUNT? | 508 |
| [[:SENSe]:WAVeform:AVERage:TCONtrol EXPonential REPEAT | 509 |
| [[:SENSe]:WAVeform:AVERage:TCONtrol? | 509 |

List of Commands

| | |
|--|-----|
| [[:SENSe]:WAVEform:AVErAge:TYPE LOG MAXimum MINimum RMS SCALar | 509 |
| [[:SENSe]:WAVEform:AVErAge:TYPE? | 509 |
| [[:SENSe]:WAVEform:AVErAge[:STATe] OFF ON 0 1 | 508 |
| [[:SENSe]:WAVEform:AVErAge[:STATe]? | 509 |
| [[:SENSe]:WAVEform:BANDwidth[:RESolution]:ACTual? | 510 |
| [[:SENSe]:WAVEform:BANDwidth BWIDth[:RESolution] <freq> | 510 |
| [[:SENSe]:WAVEform:BANDwidth BWIDth[:RESolution]:TYPE FLATtop GAUSSian | 511 |
| [[:SENSe]:WAVEform:BANDwidth BWIDth[:RESolution]:TYPE? | 511 |
| [[:SENSe]:WAVEform:BANDwidth BWIDth[:RESolution]? | 510 |
| [[:SENSe]:WAVEform:DECimate:STATe OFF ON 0 1 | 512 |
| [[:SENSe]:WAVEform:DECimate:STATe? | 512 |
| [[:SENSe]:WAVEform:DECimate[:FACTor] <integer> | 511 |
| [[:SENSe]:WAVEform:DECimate[:FACTor]? | 511 |
| [[:SENSe]:WAVEform:SWEep:TIME <time> | 512 |
| [[:SENSe]:WAVEform:SWEep:TIME? | 512 |
| [[:SENSe]:WAVEform:TRIGger:SOURce EXTernal[1] EXTernal2 FRAME IF IMMEDIATE LINE RFBurst | 513 |
| [[:SENSe]:WAVEform:TRIGger:SOURce? | 513 |

1 Introduction to GSM and EDGE

This chapter provides overall information on the GSM and EDGE communications systems Option BAF, and describes GSM and EDGE measurements made by the analyzer. Installation instructions for adding this option to your analyzer are provided in this section, if you purchased this option separately.

What Does the Agilent PSA Series and VSA E4406A do?

This instrument makes measurements that conform to the ETSI EN 300 910 (GSM 05.05), ETSI EN 300 607.1, (GSM 11.10-1), ETSI EN 301 087 (GSM 11.21), and ANSI J-STD-007 specifications. It also complies with the 3GPP TS 51.021 Base Station System (BSS) equipment specification; Radio Aspects (Release-5) V.5.3.0 (2003-06).

These documents define complex, multi-part measurements used to maintain an interference-free environment. For example, the documents include measuring the power of a carrier. The instrument automatically makes these measurements using the measurement methods and limits defined in the standards. The detailed results displayed by the measurements allow you to analyze GSM and EDGE system performance. You may alter the measurement parameters for specialized analysis.

This instrument was primarily developed for making measurements on digital transmission carriers. These measurements can help determine if a GSM transmitter is working correctly. The instrument is capable of measuring the continuous carrier of a base station transmitter.

For infrastructure test, the instrument can test base station transmitters in a non-interfering manner through use of a coupler or power splitter.

This instrument makes the following measurements:

- Transmit Power Measurement - see [page 115](#)
- GMSK Power vs. Time Measurement - see [page 94](#)
- GMSK Phase and Frequency Error Measurement - see [page 89](#)
- GMSK Output RF Spectrum (ORFS) Measurement - see [page 62](#)
- GMSK Tx Band Spur Measurement - see [page 74](#)
- EDGE Power vs. Time Measurement - see [page 50](#)
- EDGE Error Vector Magnitude (EVM) Measurement - see [page 56](#)
- EDGE Output RF Spectrum (ORFS) Measurement - see [page 62](#)
- EDGE Tx Band Spur Measurement - see [page 74](#)
- Spectrum (Frequency Domain) Measurement - see [page 104](#)
- Waveform (Time Domain) Measurement - see [page 119](#)

For conceptual information about these measurements see [Chapter 5](#), “Concepts,” on [page 521](#).

Installing Optional Measurement Personalities

When you install a measurement personality, you need to follow a three step process:

1. Determine whether your memory capacity is sufficient to contain all the options you want to load. If not, decide which options you want to install now, and consider upgrading your memory. Details follow in [“Do You Have Enough Memory to Load All Your Personality Options?”](#) on page 35.
2. Install the measurement personality firmware into the instrument memory. Details follow in [“Loading an Optional Measurement Personality”](#) on page 39.
3. Enter a license key that activates the measurement personality. Details follow in [“Obtaining and Installing a License Key”](#) on page 40.

Adding measurement personalities requires the purchase of an upgrade kit for the desired option. The upgrade kit contains the measurement personality firmware and an entitlement certificate that is used to generate a license key from the internet website. A separate license key is required for each option on a specific instrument serial number and host ID.

For the latest information on Agilent Spectrum Analyzer options and upgrade kits, visit the following web location:

http://www.agilent.com/find/sa_upgrades

Do You Have Enough Memory to Load All Your Personality Options?

If you do not have memory limitations then you can skip ahead to the next section [“Loading an Optional Measurement Personality”](#) on page 39. If after installing your options you get error messages relating to memory issues, you can return to this section to learn more about how to optimize your configuration.

If you have 64 MBytes of memory installed in your instrument, you should have enough memory to install at least four optional personalities, with plenty of memory for data and states.

The optional measurement personalities require different amounts of memory. So the number of personalities that you can load varies. This is also impacted by how much data you need to save. If you are having memory errors you must swap the applications in or out of memory as needed. If you only have 48 MBytes of memory, you can upgrade your

hardware to 64 MBytes.

Additional memory can be added to any PSA Series analyzer by installing Option 115. With this option installed, you can install all currently available measurement personalities in your analyzer and still have memory space to store more state and trace files than would otherwise be possible.

To see the size of your installed memory for PSA Series Spectrum Analyzers:

1. Ensure that the spectrum analyzer is in spectrum analyzer mode because this can affect the screen size.
2. Press **System, More, Show Hdw.**
3. Read Flash Memory size in the table. If Option 115 is installed (PSA only), the table will also show Compact Flash Type and Compact Flash Size.

| PSA Flash Memory Size | Available Memory Without Option B7J and Option 122 or 140 | Available Memory With Option B7J and Option 122 or 140 |
|-----------------------|---|--|
| 64 Mbytes | 32.5 MBytes | 30.0 MBytes |
| 48 Mbytes | 16.9 MBytes | 14.3 MBytes |

| PSA Compact Flash Memory Size | Available Additional Memory for Measurement Personalities |
|-------------------------------|---|
| 512 Mbytes (Opt. 115) | 512 MBytes |

To see the size of your installed memory for E4406A Transmitter Testers:

1. Press the **System** key, **MORE (1 of 3)**, and **MORE (2 of 3)** keys.
2. Read the **File System Key** - The total of the entries for **Used** and **Free** memory will total the installed flash memory, either 48 or 64 MBytes.

If you have 48 MBytes of memory, and you want to install more than 3 optional personalities, you may need to manage your memory resources. The following section, [“How to Predict Your Memory Requirements” on page 37](#), will help you decide how to configure your installed options to provide optimal operation.

How to Predict Your Memory Requirements

If you plan to install many optional personalities, you should review your memory requirements, so you can determine whether you have enough memory (unless you have a PSA Series with Option 115). There is an Agilent “Memory Calculator” available online that can help you do this, or you can make a calculated approximation using the information that follows. You will need to know your instrument’s installed memory size as determined in the previous section and then select your desired applications.

NOTE If you have a PSA Series analyzer with Option 115, there is adequate memory to install all of the available optional personalities in your instrument.

To calculate the available memory on your E4406, see:
<http://sa.tm.agilent.com/E4406A/memory/>

To calculate the available memory on your PSA, see:
<http://sa.tm.agilent.com/PSA/memory/>

Select the “Memory Calculator” link. You can try any combination of available personalities to see if your desired configuration is compatible with your installed memory.

NOTE For PSA: After loading all your optional measurement personalities, you should have a reserve of ~2 MBytes memory to facilitate mode switching. Less available memory will increase mode switching time. For example, if you employ excessive free memory by saving files of states and/or data, your mode switching time can increase to more than a minute.

You can manually estimate your total memory requirements by adding up the memory allocations described in the following steps. Compare the desired total with the available memory that you identified in the previous section.

1. Program memory - Select option requirements from the table “Measurement Personality Options and Memory Required” on page 38.
2. For PSA only: shared libraries require 7.72 MBytes
3. For PSA only: recommended mode swap space is 2 MBytes
4. Screens - .gif files need 20-25 kBytes each
5. State memory - State file sizes range from 21 kB for SA mode to 40 kB for W-CDMA. The state of every mode accessed since power-on will be saved in the state file. File sizes can exceed 150 kB each when several modes are accessed, for each state file saved.

TIP State memory retains settings for all states accessed before the **Save State** command. To reduce this usage to a minimum, reduce the modes accessed before the **Save State** is executed. You can set the PSA to boot into a selected

mode by accessing the desired mode, then pressing the **System**, **Power On/Presets**, **Power On** keys and toggle the setting to **Last**.

Measurement Personality Options and Memory Required

| Personality Options for PSA Series Spectrum Analyzers ^a | Option | File Size (PSA Rev: A.10) |
|---|-----------------|---------------------------------|
| cdmaOne measurement personality | BAC | 1.91 Mbytes |
| NADC and PDC measurement personalities (not available separately) | BAE | 2.43 Mbytes |
| W-CDMA or W-CDMA, HSDPA, HSUPA measurement personality | BAF, 210 | 5.38 Mbytes ^b |
| cdma2000 or cdma2000 w/ 1xEV-DV measurement personality | B78, 214 | 4.00 Mbytes ^b |
| 1xEV-DO measurement personality | 204 | 5.61 Mbytes ^b |
| GSM (with EDGE) measurement personality | 202 | 3.56 Mbytes ^b |
| Shared measurement library ^b | n/a | 7.72 Mbytes |
| Phase Noise measurement personality | 226 | 2.82 Mbytes ^c |
| Noise Figure measurement personality | 219 | 4.68 Mbytes ^c |
| Basic measurement personality with digital demod hardware | B7J | Cannot be deleted (2.64 Mbytes) |
| Programming Code Compatibility Suite ^d (8560 Series, 8590 Series, and 8566/8568) | 266 | 1.18 Mbytes ^c |
| TD-SCDMA Power measurement personality | 211 | 5.47 Mbytes ^c |
| TD-SCDMA Modulation Analysis or TD-SCDMA Modulation Analysis w/ HSDPA/8PSK measurement personality | 212, 213 | 1.82 Mbytes |
| Flexible Digital Modulation Analysis | 241 | 2.11 Mbytes ^b |
| WLAN measurement personality | 217 | 3.24 Mbytes ^b |
| External Source Control | 215 | 0.72 Mbytes ^c |
| Measuring Receiver Personality (available with Option 23A - Trigger support for AM/FM/PM and Option 23B - CCITT filter) | 233 | 2.91 Mbytes ^b |
| EMC Analyzer | 239 | 4.06 Mbytes ^b |

- Available as of the print date of this guide.
- Many PSA Series personality options use a 7.72 Mbyte shared measurement library. If you are loading multiple personalities that use this library, you only need to add this memory allocation once.
- Shared measurement library allocation not required.

d. This is a no charge option that does not require a license key.

| Personality Options for E4406A Transmitter Tester ^a | Option | File Size (E4406A Rev: A.10) |
|---|------------------|-------------------------------------|
| cdmaOne measurement personality | BAC | 1.82 Mbytes |
| NADC measurement personality | BAE | 1.10 Mbytes |
| PDC measurement personality | BAE | 1.23 Mbytes |
| W-CDMA or W-CDMA, HSDPA, HSUPA measurement personality | BAF, 210 | 5.00 Mbytes |
| cdma2000 or cdma2000 w/ 1xEV-DV measurement personality | B78, 214 | 3.88 Mbytes |
| 1xEV-DO measurement personality | 204 | 4.84 Mbytes |
| GSM (with EDGE) measurement personality | 202 | 3.56 Mbytes |
| GSM measurement personality | BAH | 2.51 Mbytes |
| EDGE upgrade from BAH measurement personality | 252 (202) | 3.56 Mbytes |
| iDEN measurement personality | HN1 | 2.10 Mbytes |
| WiDEN measurement personality | HN1 | 1.58 Mbytes |
| Baseband I/Q Inputs | B7C | n/a (hardware only) |

a. Available as of the print date of this guide.

Memory Upgrade Kits

The PSA 64 MByte Memory Upgrade kit part number is E4440AU-ANE. The PSA Compact Flash Upgrade kit part number is E4440AU-115.

The VSA 64 MByte Memory Upgrade kit part number is E4406AU-ANE.

For more information about memory upgrade kits contact your local sales office, service office, or see:

http://www.agilent.com/find/sa_upgrades

Loading an Optional Measurement Personality

You must use a PC to load the desired personality option into the instrument memory. Loading can be done from a firmware CD-ROM or by downloading the update program from the internet. An automatic loading program comes with the files and runs from your PC.

You can check the Agilent internet website for the latest PSA firmware versions available for downloading:

http://www.agilent.com/find/psa_firmware

You can check the Agilent internet website for the latest E4406 firmware versions available for downloading:

http://www.agilent.com/find/e4406a_firmware

NOTE

When you add a new option, or update an existing option, you will get the updated versions of all your current options as they are all reloaded simultaneously. This process may also require you to update the instrument core firmware so that it is compatible with the new option.

Depending on your installed hardware memory, you may not be able to fit all of the available measurement personalities in instrument memory at the same time. You may need to delete an existing option file from memory and load the one you want. Use the automatic update program that is provided with the files. Refer to the table showing “[Measurement Personality Options and Memory Required](#)” on page 38. The approximate memory requirements for the options are listed in this table. These numbers are worst case examples. Some options share components and libraries, therefore the total memory usage of multiple options may not be exactly equal to the combined total.

Obtaining and Installing a License Key

If you purchase an optional personality that requires installation, you will receive an “Entitlement Certificate” which may be redeemed for a license key specific to one instrument. Follow the instructions that accompany the certificate to obtain your license key.

To install a license key for the selected personality option, use the following procedure:

NOTE

You can also use this procedure to reinstall a license key that has been deleted during an uninstall process, or lost due to a memory failure.

For PSA:

1. Press **System, More, More, Licensing, Option** to access the alpha editor. Use this alpha editor to enter letters (upper-case), and the front-panel numeric keys to enter numbers for the option designation. You will validate your option entry in the active function area of the display. Then, press the **Enter** key.
2. Press **License Key** to enter the letters and digits of your license key. You will validate your license key entry in the active function area of the display. Then, press the **Enter** key.
3. Press the **Activate License** key.

For E4406:

1. Press **System, More, More, Install, Choose Option** to access the alpha

editor. Use this alpha editor to enter letters (upper-case), and the front-panel numeric keys to enter numbers for the option designation. You will validate your option entry in the active function area of the display. Then, press the **Done** key.

NOTE

Before you enter the license key for the EDGE Retrofit Option 252, you must already have entered the license key for the GSM Option BAH.

2. Press **License Key** to enter the letters and digits of your license key. You will validate your license key entry in the active function area of the display. Then, press the **Done** key.
3. Press the **Install Now** key. The message “New option keys become active after reboot.” will appear, along with the **Yes/No** menu: press the **Yes** key and cycle the instrument power off and then on to complete your installation process, or press the **No** key to cancel the installation process.

Viewing a License Key

Measurement personalities purchased with your instrument have been installed and activated at the factory before shipment. The instrument requires a **License Key** unique to every measurement personality purchased. The license key is a hexadecimal number specific to your measurement personality, instrument serial number and host ID. It enables you to install, or reactivate that particular personality.

Use the following procedure to display the license key unique to your personality option that is already installed in your PSA:

Press **System, More, More, Licensing, Show License**. The **System, Personality** key displays the personalities loaded, version information, and whether the personality is licensed.

Use the following procedure to display the license key unique to your personality option that is already installed in your E4406:

Press **System, More, More, Install, Choose Option** to enter the letters and numbers for the option you want. You can see the key on the **License Key** menu key. Press the **Done** key.

NOTE

*You will want to keep a copy of your license key in a secure location. Press **System, More**, then **Licensing, Show License Show System**, and print out a copy of the display that shows the license numbers. If you should lose your license key, call your nearest Agilent Technologies service or sales office for assistance.*

Using the Delete License Key on PSA

This key will make the option unavailable for use, but will not delete it from memory. Write down the 12-digit license key for the option before you delete it. If you want to use that measurement personality later, you will need the license key to reactivate the personality firmware.

NOTE

Using the **Delete License** key does not remove the personality from the instrument memory, and does not free memory to be available to install another option. If you need to free memory to install another option, refer to the instructions for loading firmware updates located at the URL :
<http://www.agilent.com/find/psa/>

1. Press **System, More, More, Licensing, Option**. Pressing the **Option** key will activate the alpha editor menu. Use the alpha editor to enter the letters (upper-case) and the front-panel numeric keyboard to enter the digits (if required) for the option, then press the **Enter** key. As you enter the option, you will see your entry in the active function area of the display.
2. Press **Delete License** to remove the license key from memory.

Using the Uninstall Key on E4406A

This key will make the option unavailable for use, but will not delete it from memory. The message “Application Not Licensed” will appear in the Status/Info bar at the bottom of the display. Record the 12-digit license key for the option before you delete it. If you want to use that measurement personality later, you will need the license key to reactivate the personality firmware.

NOTE

Using the **Uninstall** key does not remove the personality firmware from the instrument memory, and does not free memory to be available to install another option. If you need to free memory to install another option, refer to the instructions for loading firmware updates available at the URL: <http://www.agilent.com/find/vsa/>

1. Press **System, More(1 of 3), More(2 of 3), Uninstall, Choose Option** to access the alpha editor. Use this alpha editor to enter the letters (upper-case), and the front-panel numeric keys to enter the numbers (if required) for the installed option. You will validate your option entry in the active function area of the display. Then, press the **Done** key.

2. Pressing the **Uninstall Now** key will activate the **Yes/No** menu: press the **Yes** key to continue your uninstall process, or press the **No** key to cancel the uninstall process.
3. Cycle the instrument power off and then on to complete the uninstall process.

Ordering Optional Measurement Personalities

When you order a personality option, you will receive an entitlement certificate. Then you will need to go to the Web site to redeem your entitlement certificate for a license key. You will need to provide your instrument serial number and host ID, and the entitlement certificate number.

| Required Information: | Front Panel Key Path: |
|---------------------------------------|------------------------------|
| Model #: (Ex. E4440A) | |
| Host ID: _____ | System, Show System |
| Instrument Serial Number: _____ | System, Show System |

GSM and EDGE Measurements

The following measurements for the GSM 450, GSM 480, GSM 700, GSM 850, GSM 900, DCS 1800, and PCS 1900 bands are available by pressing the **Measure** key (except for the Tx Band Spurs and EDGE Tx Band Spurs measurements, which support P-GSM, E-GSM, R-GSM, DCS 1800, and PCS 1900 only):

These are referred to as one-button measurements. When you press the key to select the measurement, it becomes the active measurement, using settings and a display unique to that measurement. Data acquisitions automatically begin, provided trigger requirements, if any, are met.

Transmit Power – This test verifies in-channel power for GSM and EDGE systems. Good measurement results ensure that dynamic power control is optimized, overall system interference is minimized, and mobile station battery life is maximized. See [“Transmit Power Measurements” on page 115](#)

Power vs. Time – Verifies that the transmitter output power has the correct amplitude, shape, and timing for the GSM or EDGE format. GMSK and EDGE versions of this measurement are available. See [“GMSK Power vs. Time \(PvT\) Measurements” on page 94](#) and [“EDGE Power vs. Time \(PVT\) Measurements” on page 50](#).

Output RF Spectrum (ORFS) – Verifies that the modulation, wideband noise, and power level switching spectra are within limits and do not produce significant interference in the adjacent base transceiver station (BTS) channels. GMSK and EDGE versions of this measurement are available. See [“GMSK Output RF Spectrum \(ORFS\) Measurements” on page 77](#) and [“EDGE Output RF Spectrum \(ORFS\) Measurements” on page 62](#).

Tx Band Spur – Verifies that a BTS transmitter does not transmit undesirable energy into the transmit band. This energy may cause interference for other users of the GSM system. GMSK and EDGE versions of this measurement are available. See [“GMSK Transmitter Band Spurious Signal \(Tx Band Spur\) Measurements” on page 101](#) and [“EDGE Tx Band Spur Measurements” on page 74](#).

Phase and Frequency – Verifies modulation quality of the 0.3 GMSK signal for GSM systems. The modulation quality indicates the carrier to noise performance of the system, which is critical for mobiles with low signal levels, at the edge of a cell, or under difficult fading or Doppler conditions. See [“GMSK Phase and Frequency Error Measurements” on page 89](#).

Error Vector Magnitude (EVM) – Provides a measure of

modulation accuracy. The EDGE 8 PSK modulation pattern uses a rotation of $3\pi/8$ radians to avoid zero crossing, thus providing a margin of linearity relief for amplifier performance. This is an EDGE only measurement. See [“EDGE Error Vector Magnitude \(EVM\) Measurements”](#) on page 56.

Spectrum – Provides spectrum analysis capability similar to a swept tuned analyzer. The spectrum measurement is FFT (Fast Fourier Transform) based. See [“Spectrum \(Frequency Domain\) Measurements”](#) on page 104.

Waveform – Enables you to view waveforms in the time domain. This measurement provides fast zero span functionality which is a crucial feature of traditional spectrum analyzers. See [“Waveform \(Time Domain\) Measurements”](#) on page 119.

For E4406A, Baseband I/Q Inputs, Option B7C, is available for use with these measurements. For details see [“Using Option B7C Baseband I/Q Inputs”](#) on page 131.

Setting up and Making a Measurement

Making the Initial Signal Connection

CAUTION

Before connecting a signal to the instrument, make sure the instrument can safely accept the signal level provided. The signal level limits are marked next to the connectors on the front panel.

See “Input Key Menu” for details on selecting input ports and setting internal attenuation to prevent overloading the instrument.

For PSA only: The “Input Key Menu” also provides details of the internal preamplifier (**Int Preamp**) operation.

Using Instrument Mode and Measurement Presets

If you want to set your current measurement personality to a known, factory default state, press **Preset**. This initializes the instrument by returning the mode setup and all of the measurement setups in the mode to the factory default parameters.

NOTE

For PSA, note that pressing the **Preset** key will switch instrument modes unless the type of preset is selected under **System, Power On/Preset** is set to **Mode** or **Save User Preset**.

To preset only the parameters that are specific to an active, selected measurement, press **Meas Setup**, then **Restore Meas Defaults**. **Restore Meas Defaults** will return all the measurement setup parameters to the factory defaults, but only for the currently selected measurement. The **Restore Meas Defaults** key may not appear on the first page of the **Meas Setup** menu. If not, press **More** until the key is available.

The 3 Steps to Set Up and Make Measurements

All measurements need to be set up in 3 steps: first at the Mode level, second at the Measurement level, then finally the result display may be adjusted.

1. Select and Set Up the Mode

Press **MODE** - All licensed, installed Modes available are shown.

Press **EDGE w/ GSM, GSM**, or select **Basic** mode to make measurements of signals with non-standard formats.

Press **Mode Setup** - Make any required adjustments to the mode settings. These settings apply to all measurement in the mode.

2. Select and Set Up the Measurement

Press **MEASURE** - Select a specific measurement to be performed (for example. **ACP, Spectrum** or **Waveform**). The measurement begins as soon as any required trigger conditions are met. The resulting data is shown on the display or is available for export.

Press **Meas Setup** - Make any adjustments as required to the selected measurement settings. The settings only apply to this measurement.

3. Select and Set Up a View of the Results

Press **Trace/View** - Select a display format for the current measurement data. Depending on the mode and measurement selected, other graphical and tabular data presentations may be available. **X-Scale** and **Y-Scale** adjustments may also be made now.

NOTE

A setting may be reset at any time, and will be in effect on the next measurement cycle or View.

| Step | Primary Key | Setup Keys | Related Keys |
|--|--|--|---|
| 1. Select & set up a Mode | MODE | Mode Setup, Input (E4406A), Input/Output (PSA), FREQUENCY Channel | System |
| 2. Select & set up a Measurement | MEASURE | Meas Setup | Meas Control, Restart |
| 3. Select & set up a View of the Results | View/Trace (E4406A), Trace/View (PSA) | SPAN X Scale, AMPLITUDE Y Scale, Display, Next Window, Zoom | File, Save, Print, Print Setup, Marker, Search (E4406A), Peak Search (PSA) |

EDGE Power vs. Time (PvT) Measurements

This section explains how to make an EDGE Power versus Time (PvT) measurement on an EDGE base station. Good PvT measurement results verify that the transmitter output power has the correct amplitude, shape, and timing for the EDGE format.

NOTE This measurement is designed for EDGE. For the GSM PvT measurement see “GMSK Power vs. Time (PvT) Measurements” on page 94.

Configuring the Measurement System

This example shows a base station (BTS) under test set up to transmit RF power, and being controlled remotely by a system controller. The transmitting signal is connected to the analyzer RF input port. Connect the equipment as shown.

Figure 2-1 EDGE Pwr vs Time Measurement System

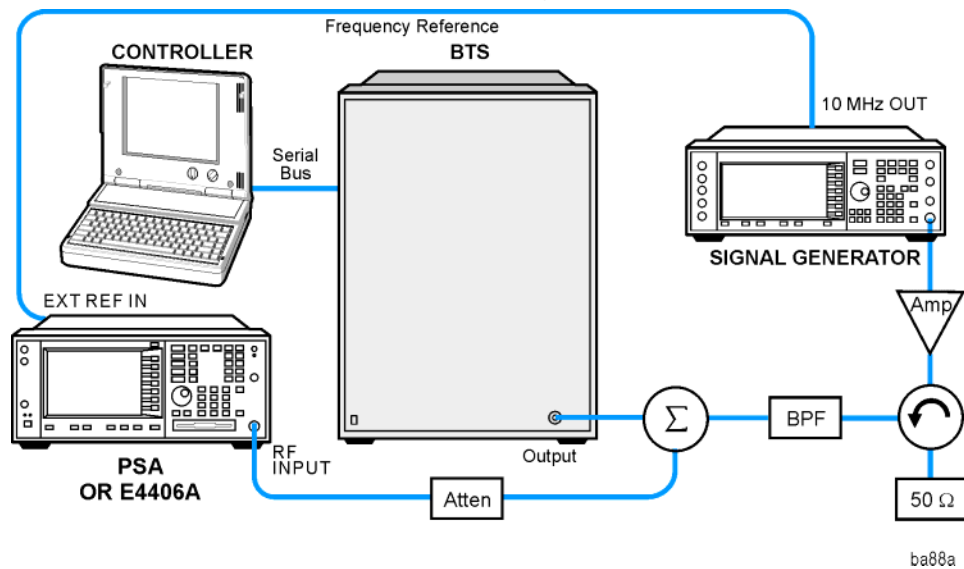

1. Using the appropriate cables, adapters, and circulator, connect the output signal of the BTS to the RF input of the instrument.
2. Connect the base transmission station simulator or signal generator to the BTS through a circulator to initiate a link constructed with sync and pilot channels, if required.
3. Connect a BNC cable between the 10 MHz OUT port of the signal generator and the EXT REF IN port of the instrument.
4. Connect the system controller to the BTS through the serial bus cable to control the BTS operation.

Setting the BTS (Example)

From the base transmission station simulator and the system controller, set up a call using loopback mode for the BTS to transmit the RF power as follows:

BTS: Symbol Rate: 270.833kbps
Frequency: 935.2000 MHz (ARFCN number 1)
Output Power: -3 dBW (0.5 W)

Measurement Procedure

- Step 1.** Press the **Preset** key to preset the instrument.
- Step 2.** Press the **MODE, GSM (w/EDGE)** keys to enable the GSM with EDGE mode measurements.
- Step 3.** Press the **Mode Setup, Trigger** keys to select a trigger source as described in the section titled [“EDGE Power vs. Time Measurement Keys” on page 177](#).
- Step 4.** Press the **Radio, Band** keys to select the desired band. This determines the frequency and band-related presets. Our example uses the default setting, **P-GSM**.
- Step 5.** Press the **FREQUENCY Channel** key to select the desired center frequency or ARFCN as described in the section titled [“FREQUENCY Channel Key Menu” on page 143](#).
- Step 6.** Press the **Burst Type** key to select the desired burst type as described in the section titled [“FREQUENCY Channel Key Menu” on page 143](#).
- Step 7.** If your signal of interest contains more than 1 Training Sequence, press the **TSC** key, and select a standard Training Sequence (numbered 0-7) to which the measurement will synchronize. The default setting for **TSC** is **Auto**, which automatically correlates to any one of the standard Training Sequences numbered 0-7. See [“FREQUENCY Channel Key Menu” on page 143](#).
- Step 8.** Press the **MEASURE, EDGE Pwr vs Time** keys to initiate the EDGE Power vs. Time measurement.
- Step 9.** Press the **Meas Setup, More, Pwr Ctrl Lvl** keys to select the desired power control level. The following example uses the default setting **0**.

Results

The views available under the **View/Trace** menu are **Burst**, **Rise & Fall**, and **Multi-Slot**. For more information see “[EDGE Power vs. Time Measurement Keys](#)” on page 177.

Information shown in the left margin of the displays include:

MaxP - This is total input power allowed for the measurement. This value is coupled to the internal RF **Input Atten** setting.

ExtAt - This value reflects the **External RF Atten** setting.

Sync - The **Burst Sync** setting used in the current measurement.

Trig - The **Trigger Source** setting used in the current measurement.

The **Mean Transmit Power** is displayed at the bottom left of the Burst and Rise & Fall views:

Mean Transmit Power - This is the RMS average power across the “useful” part of the burst, or the 147 bits centered on the transition from bit 13 to bit 14 (the “T0” time point) of the 26 bit training sequence. An RMS calculation is performed and displayed regardless of the averaging mode selected for the trace data.

If Averaging = ON, the result displayed is the RMS average power of all bursts measured. If Averaging = OFF, the result is the RMS average power of the single burst measured. This is a different measurement result from Mean Transmit Pwr, below.

The **Current Data** displayed at the bottom of the Burst and Rise & Fall views include:

Mean Transmit Pwr - This result appears only if Averaging = ON. It is the RMS average of power across the “useful” part of the burst, for the current burst only. If a single measurement of “n” averages has been completed, the result indicates the Mean Transmit Pwr of the last burst. The RMS calculation is performed and displayed regardless of the averaging mode selected for the trace data. This is a different measurement result from Mean Transmit Power, above.

Max Pt. - Maximum signal power point in dBm.

Min Pt. - Minimum signal power point in dBm.

Burst Width - Time duration of burst at -3 dB power point (half-power).

Mask Ref Pwr Midamble - The Mask Reference Power is the average power in dBm of the middle 16 symbols in the midamble. The times displayed are the corresponding start and stop times of the middle 16 symbols.

1st Error Pt - (Error Point) The time (displayed in ms or μ s)

indicates the point on the X Scale where the first failure of a signal was detected. Use a marker to locate this point in order to examine the nature of the failure.

Figure 2-2 EDGE Power vs. Time Result - Burst View

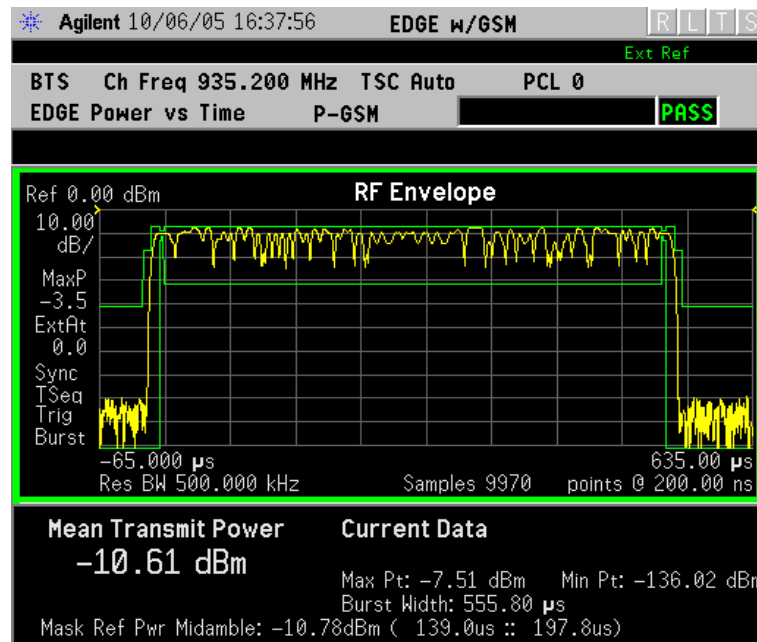

Figure 2-3 EDGE Power vs. Time Result - Rise & Fall View

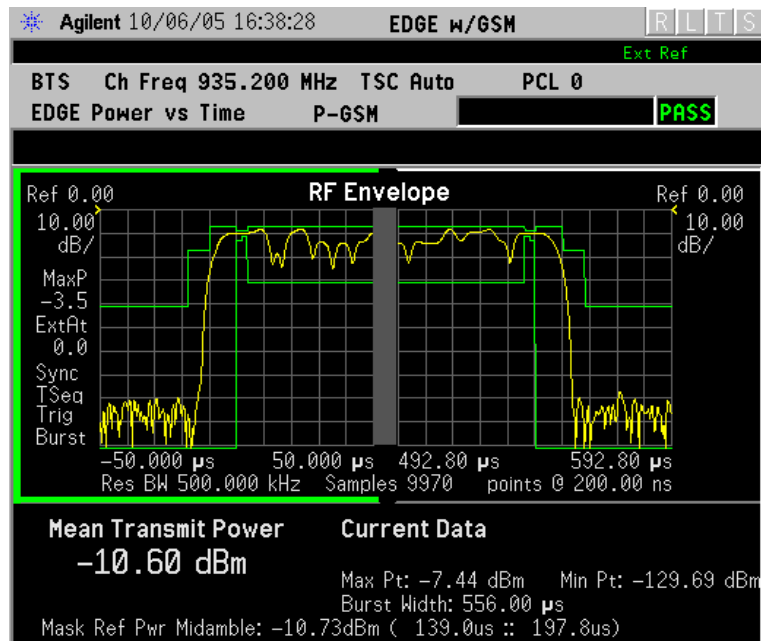
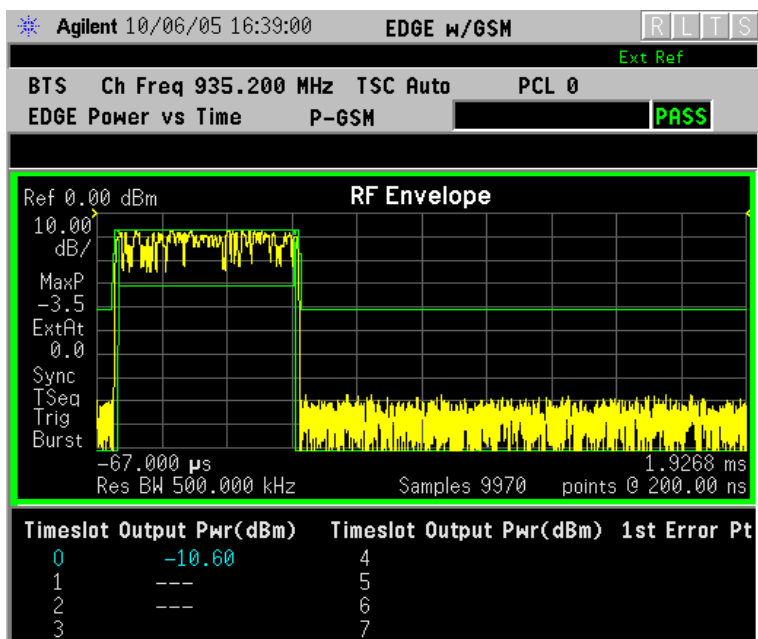

Figure 2-4 EDGE Result - Multi-Slot View



The table in the lower portion of the multi-slot view shows the output power in dBm for each timeslot, as determined by the integer (1 to 8) entered in the **Meas Setup, Meas Time** setting. Output power levels are presented for the active slots, and a dashed line appears for any slot that is inactive. The timeslot that contains the burst of interest is highlighted in blue.

Use the **Meas Time** key located in the **Meas Setup** menu to select up to eight slots. Use the **Timeslot** and **TSC** keys in the **Frequency/Channel** menu to select the slot you wish to activate. Setting **Timeslot** to **ON** and selecting a specific slot results in activating a measurement of that slot only (**Timeslot On** can be used to isolate a failure to a specific slot). When **Timeslot** is set to **OFF**, all active slots are tested against the mask.

Using a signal generator you can synchronize the multi-slot view so the frame (or portion of the frame) you are viewing starts with the slot you have selected. See [“EDGE Power vs. Time Measurement Concepts” on page 542](#).

You can switch from the multi-slot view directly to the burst or rise and fall views of the slot that is currently active. The **Scale/Div** key under the **Span/Y Scale** menu can be used to enlarge your view of this signal.

Figure 2-5 EDGE PVT Result - Custom Limit Mask Example of Two Consecutive Bursts

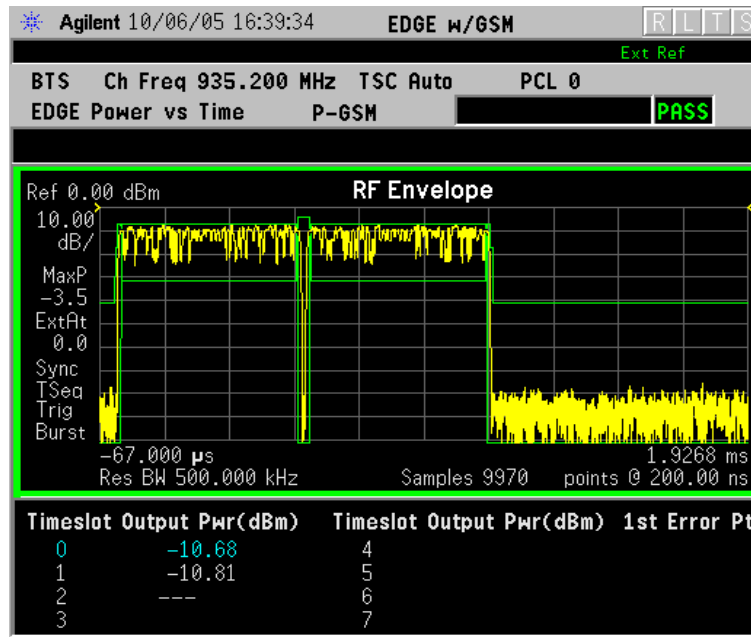

For more information on making measurements of two consecutive bursts, including the SCPI commands used to make the measurement, refer to the section in the Programming Commands chapter. See “EDGE PVT Custom Limit Mask Example of Two Consecutive Bursts” on page 428.

For More Information

For more details about changing measurement parameters, see “EDGE Power vs. Time Measurement Concepts” on page 542.

If you have a problem, and get an error message, see “Interpreting Error Codes” on page 137.

Troubleshooting Hints

If a transmitter fails the EDGE Power vs. Time measurement this usually indicates a problem with the units output amplifier or leveling loop.

Setting the BTS (Example)

From the base transmission station simulator and the system controller, set up a call using loopback mode for the BTS to transmit the RF power as follows:

BTS: Symbol Rate: 270.833kbps
Frequency: 935.2000 MHz (ARFCN number 1)
Output Power: -3 dBW (0.5 W)

Measurement Procedure

- Step 1.** Press the **Preset** key to preset the instrument.
- Step 2.** Press the **MODE, GSM (w/EDGE)** keys to enable the GSM with EDGE mode measurements.
- Step 3.** Press the **Mode Setup, Trigger** keys to select a trigger source as described in the section titled [“EDGE EVM \(Error Vector Magnitude\) Measurement Keys”](#) on page 156.
- Step 4.** Press the **FREQUENCY Channel** key to select the desired center frequency or ARFCN as described in the section titled [“FREQUENCY Channel Key Menu”](#) on page 143.
- Step 5.** Press the **Burst Type** key to select the desired burst type as described in the section titled [“FREQUENCY Channel Key Menu”](#) on page 143.
- Step 6.** If your signal of interest contains more than 1 Training Sequence, press the **TSC** key, and select a standard Training Sequence (numbered 0-9) to which the measurement will synchronize. The default setting for **TSC** is **Auto**, which automatically correlates to any one of the standard Training Sequences numbered 0-9. See [“FREQUENCY Channel Key Menu”](#) on page 143.
- Step 7.** Press the **MEASURE, EDGE EVM** keys to initiate the EDGE Error Vector Magnitude measurement.

Step 8. (Optional for Device = MS only.) Perform Polar modulation Analysis: Press **Meas Setup, Burst Sync, Polar Mod Sync**.

The instrument searches the training sequence on the amplitude path and phase path and try to sync. Polar modulation analysis measures the time delay adjustment between the Amplitude path and Phase path for Polar modulation. When **Polar Mod Sync** is selected, the timing offset of amplitude path to phase path is always calculated.

The displayed time delay values are called $AMPM$ Offset and $T0$ Offset. They are shown in the Polar Vector view, Polar Constln view and Data bits view. You can select time (seconds) or symbols as the display unit using **Time Offset Unit** in the **Display** key menu.

The **Polar Mod Align On/Off** key located in the **Meas Setup** menu. The **Polar Mod Align** setting determines whether the timing offsets are used (**ON**) for compensation in the EVM calculation.

The next figure shows an example of measurement result with the graphic and text windows. The measured summary data is shown in the left window and the dynamic vector trajectory of the I/Q demodulated signal is shown as a polar vector display in the right window.

Figure 2-7

EDGE EVM Result - Polar Vector View

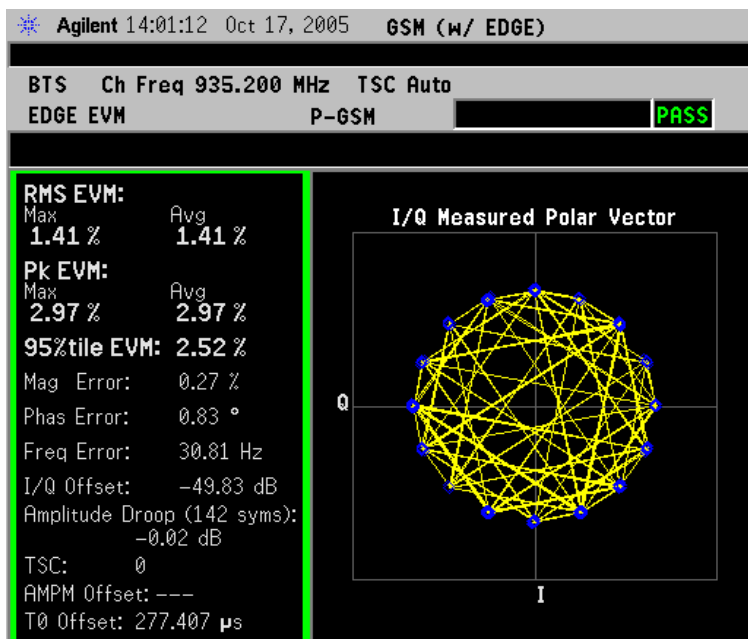

Step 9. Press **View/Trace, Polar Constellation** to view a plot of constellation “dots” or states without the vector lines.

Step 10. Press **View/Trace, I/Q Error (Quad-View)** to display a four-pane view of the Magnitude Error, Phase Error, and EVM graphs, along with a summary of the measurement data. You can select any of the graph windows for individual display or adjustment by pressing **Next Window** and moving the green selection box to the desired window. Press **Zoom** to expand the window to full screen, or to go back to the Quad-View.

In the example below, a sine modulation is apparent in the EVM and Phase Error data. This could due to an FM impairment that is not discernible in the other EVM views.

Figure 2-8

EDGE EVM Result - I/Q Error (Quad-View)

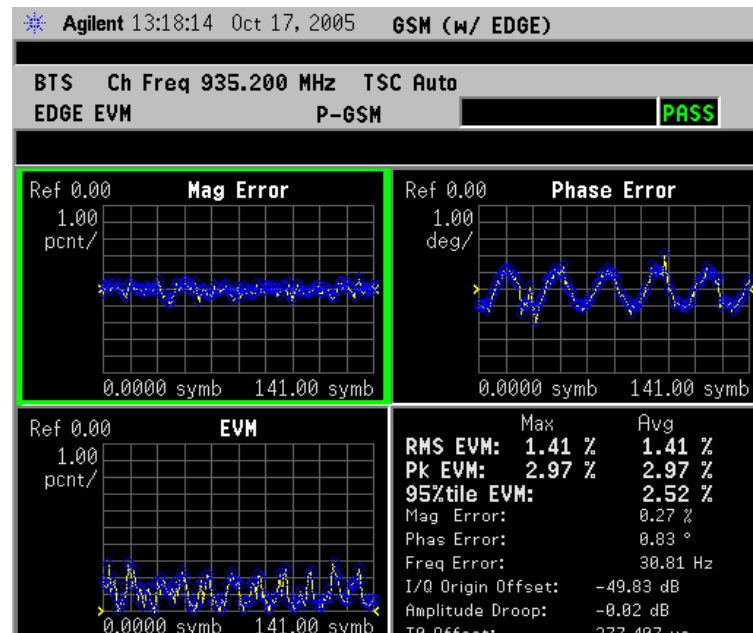

Step 11. Press **View/Trace, Data Bits** to display a summary of measurement data along with the symbol state bits. The training sequence is highlighted in blue, and remains constant with repeated measurement updates.

Figure 2-9 EDGE EVM Result - Data Bits View

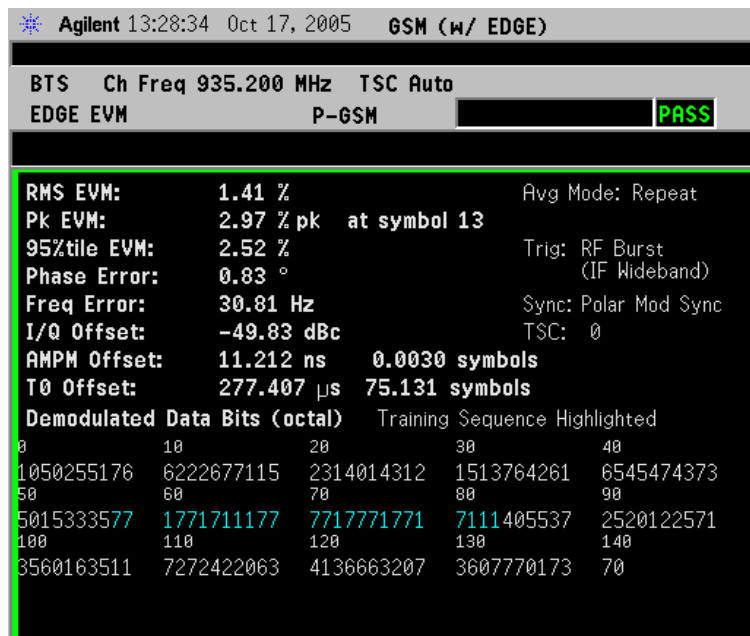

NOTE The data bits in this display are Symbol State bits, and do not represent encoded message data.

For More Information

For more details about changing measurement parameters, see [“EDGE EVM Measurement Concepts” on page 544.](#)

If you have a problem, and get an error message, see [“Interpreting Error Codes” on page 137.](#)

Troubleshooting Hints

Use the spectrum (frequency domain) measurement to verify that the signal is present and approximately centered on the display.

The data used for testing can have a detrimental effect on the EVM results, causing erratic or falsely high EVM, especially in the case of sending all 0 bits with the Trigger Source set to RF Burst. In that unique situation, better results may be obtained using Free Run or Video triggers.

Poor EVM indicates a problem at the I/Q baseband generator, filters, and/or modulator in the transmitter circuitry. The output amplifier in the transmitter can also create distortion that causes unacceptably

high EVM. In a real system, poor EVM reduces the ability of a receiver to correctly demodulate the signal, especially in marginal signal conditions. Poor EVM may also indicate that a measurement restart was not performed after the signal level was changed. Press **Restart** after a change in the input signal to ensure that an auto-attenuation adjustment is performed.

The I/Q Error Quad View display may be used to determine where modulation or demodulation errors are introduced into the complex modulated path.

EDGE Output RF Spectrum (ORFS) Measurements

This section explains how to make an EDGE Output RF Spectrum measurement on an EDGE base station. This test verifies that the modulation, wideband noise, and power level switching spectra are within limits and do not produce significant interference in the adjacent base transceiver station (BTS) channels.

NOTE This measurement is designed for EDGE. For the GSM Output RF Spectrum measurement see “GMSK Output RF Spectrum (ORFS) Measurements” on page 77.

Configuring the Measurement System

This example shows a base transceiver station (BTS) under test set up to transmit RF power, and being controlled remotely by a system controller. The transmitting signal is connected to the analyzer RF input port. Connect the equipment as shown.

Figure 2-10 EDGE ORFS Measurement System

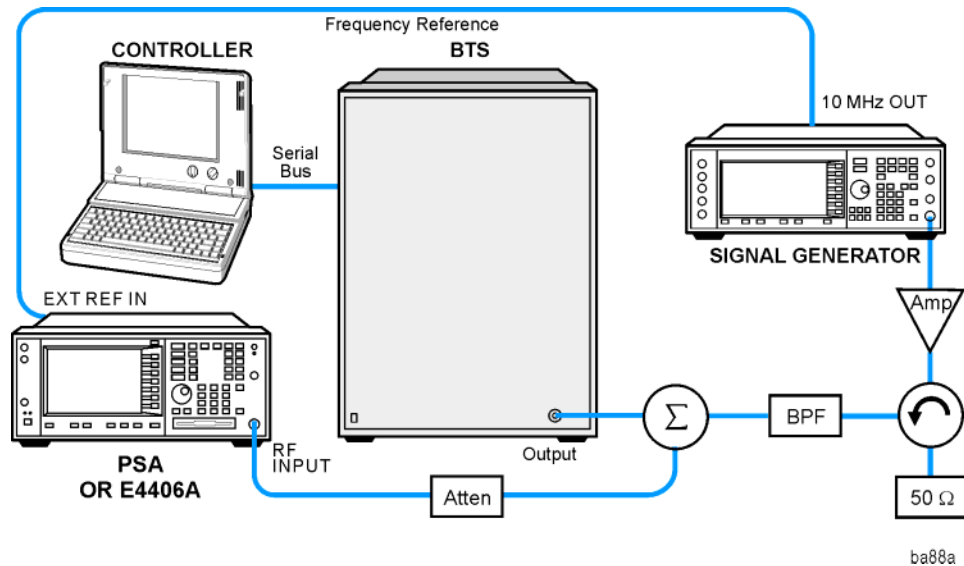

1. Using the appropriate cables, adapters, and circulator, connect the output signal of the BTS to the RF input of the instrument.
2. Connect the base transmission station simulator or signal generator to the BTS through a circulator to initiate a link constructed with sync and pilot channels, if required.
3. Connect a BNC cable between the 10 MHz OUT port of the signal generator and the EXT REF IN port of the instrument.

4. Connect the system controller to the BTS through the serial bus cable to control the BTS operation.

NOTE

If the signal being measured has more than one active slot in a frame, the default RF Burst trigger must be changed, and an external event trigger must be provided to synchronize the frame. Otherwise the measurement may trigger randomly on any burst in an active slot. This is true for all ORFS time domain measurements.

Setting the BTS (Example)

From the base transmission station simulator and the system controller, set up a call using loopback mode for the BTS to transmit the RF power as follows:

BTS: Symbol Rate: 270.833kbps
Frequency: 935.2000 MHz (ARFCN number 1)
Output Power: -3 dBW (0.5 W)

Measurement Procedure

- Step 1.** Press the **Preset** key to preset the instrument.
- Step 2.** Press the **MODE, GSM (w/EDGE)** keys to enable the EDGE mode measurements.
- Step 3.** Press the **Mode Setup, Trigger** keys to select a trigger source as described in the section titled [“EDGE Output RF Spectrum Measurement Keys” on page 166](#).
- Step 4.** Press the **Demod, Burst Align** keys to toggle the burst alignment to **1/2 Bit Offset**.
- Step 5.** Press the **FREQUENCY Channel** key to select the desired center frequency or ARFCN as described in the section titled [“FREQUENCY Channel Key Menu” on page 143](#).
- Step 6.** Press the **Burst Type** key to select the desired burst type as described in the section titled [“FREQUENCY Channel Key Menu” on page 143](#).
- Step 7.** If your signal of interest contains more than 1 Training Sequence, press the **TSC** key, and select a standard Training Sequence (numbered 0-9) to which the measurement will synchronize. The default setting for **TSC** is **Auto**, which automatically correlates to any one of the standard Training Sequences numbered 0-9. See [“FREQUENCY Channel Key Menu” on page 143](#).

Step 8. Press **Meas Setup** and select the **Meas Type** and **Meas Method** for your measurement:

- **Meas Type** - Accesses a menu to choose the measurement that is optimized for the type of spectral distortion being investigated.

Mod & Switch - Performs both Modulation and Switching measurements, which measures the spectrum due to the 0.3 GMSK modulation and noise, and also measures Switching (transient) spectrum measurements.

Modulation - Measures the spectrum optimized for distortion due to the 0.3 GMSK modulation and noise.

Switching - Measures the spectrum optimized for distortion due to switching transients (burst ramping).

Full Frame Modulation (FAST)- Improves measurement speed by acquiring a full frame of data prior to performing the FFT calculation. This feature can only be used when all slots in the transmitted frame are active. Use of an external trigger can enhance measurement speed when this feature is used. When **Full Frame Modulation (FAST)** is selected the current measurement defaults to the multi-offset measurement method. Therefore, the **Meas Method** key is grayed out and the **Single Offset** feature is not available.

- **Meas Method**

Multi-Offset - Automatically makes measurements at all offset frequencies in the selected list (**Standard**, **Short**, or **Custom**). Press the **Multi-Offset Freq List** key to select a list of offsets to measure.

Multi-Offset measurements may be made with either **Modulation** or **Switching** measurement types.

Offset measurement results are displayed as tabular data, and may be viewed as either absolute powers in the Modulation Power and Switching Power views, or as powers relative to the margins and limit settings in the Modulation Margin and Limit and Switching Margin and Limit views. See [“Trace/View Key Menu” on page 160](#), and [Figure 2-11 on page 65](#).

Single Offset (Examine) - makes a measurement at a single offset frequency as set by the **Single Offset Freq** softkey.

Single Offset (Examine) measurements may be made with either **Modulation** or **Switching** measurement types.

Single offset measurement results are displayed in a time domain plot, with the measurement offset shown as a gate by white vertical lines. See [Figure 2-15 on page 69](#).

Swept - makes a measurement using time-gated spectrum analysis to sweep the analyzer with the gate turned on for the desired portion of the burst only, as set by the **Modulation Offs (offsets) & Limits** menu. The limits mask is applied to the spectrum plot, and the Worst Frequency parameters are displayed. This selection is only available if **Meas Type** is set to **Modulation**. See [Figure 2-18 on page 72](#).

- Accesses a menu to choose the measurement mode.

Step 9. Press the **Restart** key to re-initiate an EDGE ORFS measurement if you change the **Meas Type** or **Meas Method**. You can also set **Meas Control** to **Measure Cont** for continuous measurements.

For more details about changing measurement parameters, see [“EDGE Output RF Spectrum Measurement Keys” on page 166](#) and [“EDGE Output RF Spectrum Measurement Concepts” on page 549](#).

If you have a problem, and get an error message, see [“Interpreting Error Codes” on page 137](#).

EDGE ORFS Measurement Results

- **Modulation Power** - When **Meas Method** is set to **Multi-Offset**, and **Meas Type** is set to **Modulation**, or **Mod and Switch**, measurement results may be viewed as absolute powers in tabular form. The data displays offsets from any of the **Multi-Offset Freq List** settings: **Standard**, **Short**, and **Custom**. The **Modulation Power** view is the default view for ORFS measurements. You can select the **Modulation Power** view by pressing **View/Trace**, then **Modulation Power**.

Figure 2-11 EDGE ORFS - Example (Short List) Modulation Power View

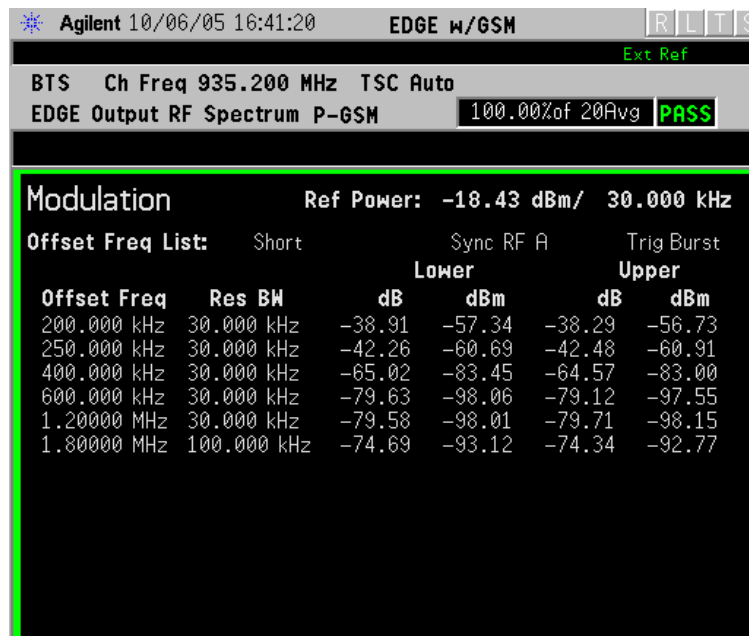

- **Modulation Margin & Limits**- When **Meas Method** is set to **Multi-Offset**, and **Meas Type** is set to **Modulation**, or **Mod and Switch**, measurement results may be viewed as relative powers in tabular form. The data displays offsets from any of the **Multi-Offset Freq List** settings: **Standard**, **Short**, and **Custom**, and shows the limit values selected by frequency, with the corresponding measurement result deltas.

You can select the **Modulation Margin and Limits** view by pressing **View/Trace**, then **Modulation Margin and Limits**.

Figure 2-12 EDGE ORFS Result - Example (Short List) Modulation Margin & Limits View

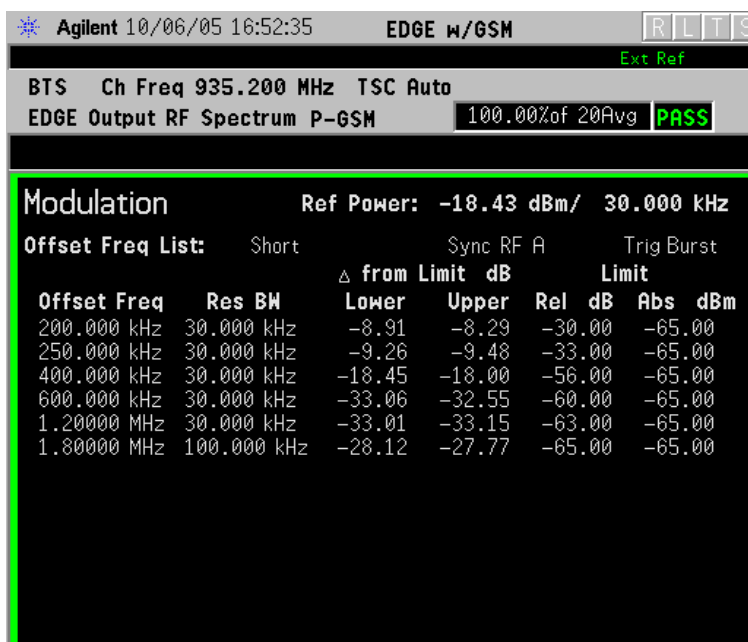

For more details about changing measurement parameters, see “EDGE Output RF Spectrum Measurement Keys” on page 166 and “EDGE Output RF Spectrum Measurement Concepts” on page 549.

If you have a problem, and get an error message, see “Interpreting Error Codes” on page 137.

- **Switching Power** - When **Meas Method** is set to **Multi-Offset**, and **Meas Type** is set to **Switching**, or **Mod and Switch**, measurement results may be viewed as absolute powers in tabular form. The data displays offsets from any of the **Multi-Offset Freq List** settings: **Standard**, **Short**, and **Custom**.

You can select the **Switching Power** view by pressing **View/Trace**, then **Switching Power**.

Figure 2-13 EDGE ORFS Result - Example (Short List) Switching Power View

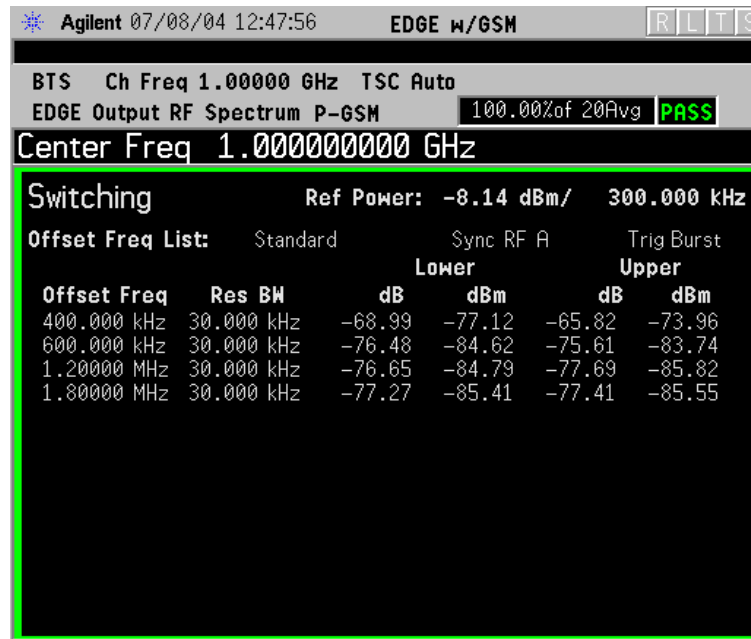

For more details about changing measurement parameters, see “EDGE Output RF Spectrum Measurement Keys” on page 166 and “EDGE Output RF Spectrum Measurement Concepts” on page 549.

If you have a problem, and get an error message, see “Interpreting Error Codes” on page 137.

- **Switching Margin & Limits** - When **Meas Method** is set to **Multi-Offset**, and **Meas Type** is set to **Switching** or **Mod and Switch**, measurement results may be viewed as relative powers in tabular form. The data displays offsets from any of the **Multi-Offset Freq List** settings: **Standard**, **Short**, and **Custom**, and shows the limit values selected by frequency, with the corresponding measurement result deltas.

You can select the **Switching Margin & Limits** view by pressing **View/Trace**, then **Switching Margin & Limits**.

Figure 2-14 EDGE ORFS Result - Switching Margin & Limits View



For more details about changing measurement parameters, see “EDGE Output RF Spectrum Measurement Keys” on page 166 and “EDGE Output RF Spectrum Measurement Concepts” on page 549.

If you have a problem, and get an error message, see “Interpreting Error Codes” on page 137.

Single Offset (Examine) - makes a measurement at a single offset frequency as set by the **Single Offset Freq** softkey.

Single offset measurement results are displayed as a power waveform in a time domain plot, with the measurement offset shown as a gate by white vertical lines. The red vertical lines represent the additional effective measurement window when **Fast Avg** is **ON** (default setting).

NOTE

The signal being displayed below is the useful part of slot 1, which in this example, is the only active slot in the frame. If any other slots are active, the default RF Burst trigger must be changed, and an external event trigger must be provided to synchronize the frame. Otherwise the measurement may trigger randomly on any burst in an active slot. This is true for all ORFS measurements.

Figure 2-15 EDGE ORFS Result - Modulation Single Offset (Examine) View

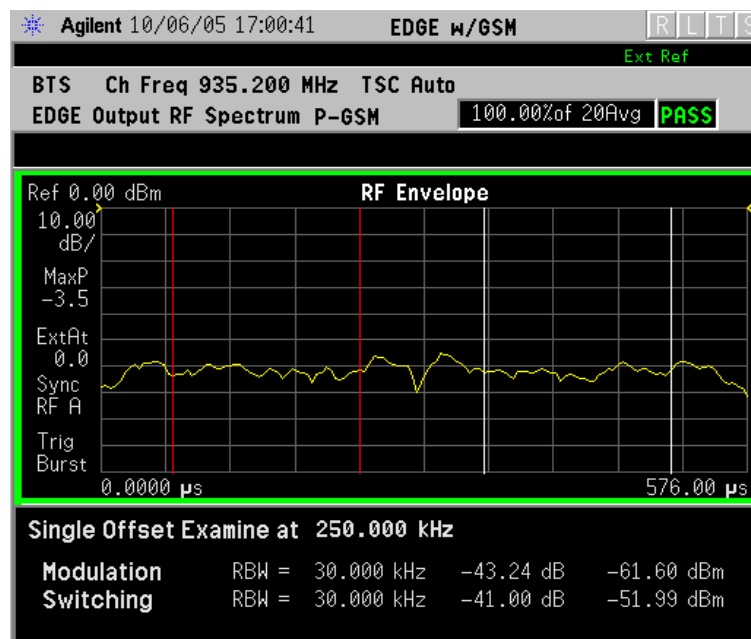

For more details about changing measurement parameters, see [“EDGE Output RF Spectrum Measurement Keys”](#) on page 166 and [“EDGE Output RF Spectrum Measurement Concepts”](#) on page 549.

If you have a problem, and get an error message, see [“Interpreting Error Codes”](#) on page 137.

Switching Single Offset measurement results are displayed in a time domain plot, but the waveform of the entire frame is displayed. In this example, slots 1 and 4 are active. Use the external trigger to maintain frame synchronization. **Fast Avg** is not available for this measurement.

Figure 2-16 EDGE ORFS Result - Switching Single Offset (Examine) View

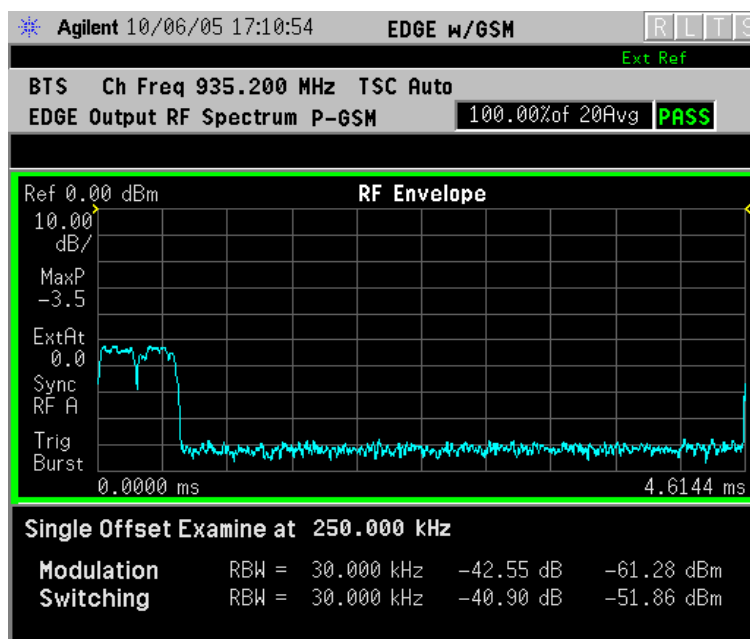

For more details about changing measurement parameters, see “EDGE Output RF Spectrum Measurement Keys” on page 166 and “EDGE Output RF Spectrum Measurement Concepts” on page 549.

If you have a problem, and get an error message, see “Interpreting Error Codes” on page 137.

Combination Modulation and Switching (**Mod & Switch**) Single Offset measurement results are displayed in a time domain plot, but the waveform of the entire frame is displayed. The blue trace is the Switching data and the yellow trace is the Modulation data, with the measurement gates shown.

In this example, slots 1 and 4 are active. Use the external trigger to maintain frame synchronization. **Fast Avg** is not available for this measurement.

Figure 2-17 EDGE ORFS Result - Mod & Switch Single Offset (Examine) View

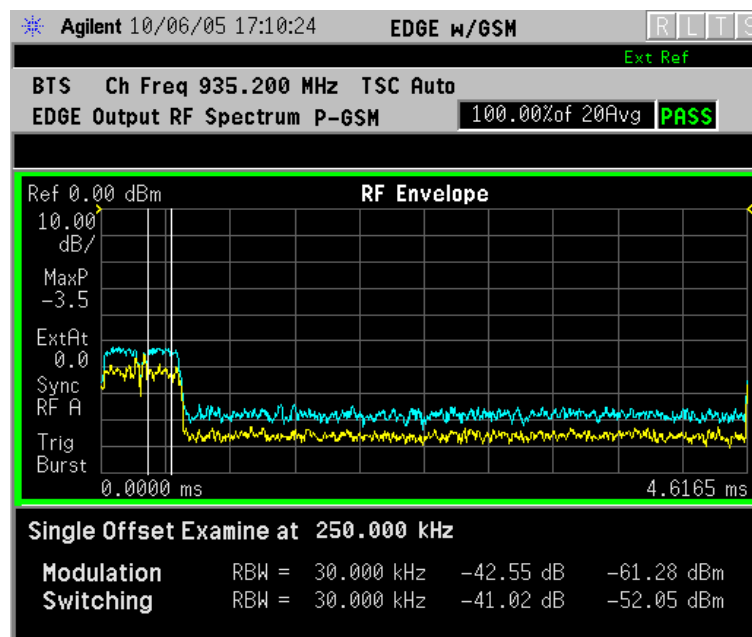

For more details about changing measurement parameters, see “EDGE Output RF Spectrum Measurement Keys” on page 166 and “EDGE Output RF Spectrum Measurement Concepts” on page 549.

If you have a problem, and get an error message, see “Interpreting Error Codes” on page 137.

- **Swept** - When **Meas Type** is set to **Modulation** and **Meas Method** is set to **Swept**, measurement results may be viewed in the spectrum domain, with the limit mask applied to the spectrum plot, and the **Worst Frequency** parameters displayed. This selection is only available if **Meas Type** is set to **Modulation**.

Figure 2-18 EDGE ORFS Result - Example Modulation Swept View

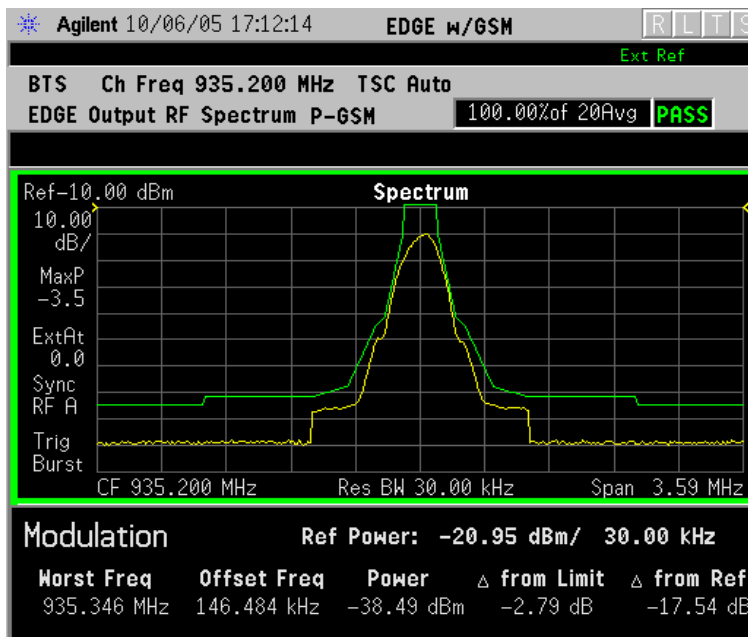

For more details about changing measurement parameters, see “EDGE Output RF Spectrum Measurement Keys” on page 166 and “EDGE Output RF Spectrum Measurement Concepts” on page 549.

If you have a problem, and get an error message, see “Interpreting Error Codes” on page 137.

- **Full Frame Mode (FAST)** - When **Meas Method** is set to **Multi-Offset**, and **Meas Type** is set to **Full Frame Mode (FAST)**, measurement results may be viewed as relative and absolute powers in tabular form. The data displays offsets from any of the **Multi-Offset Freq List** settings: **Standard**, **Short**, and **Custom**.

To measure **Full Frame Mode (FAST)**, all slots in the frame must be active. In the example below, slots 6 and 7 were inactive.

Figure 2-19 EDGE ORFS Result - Full Frame Modulation (FAST) View

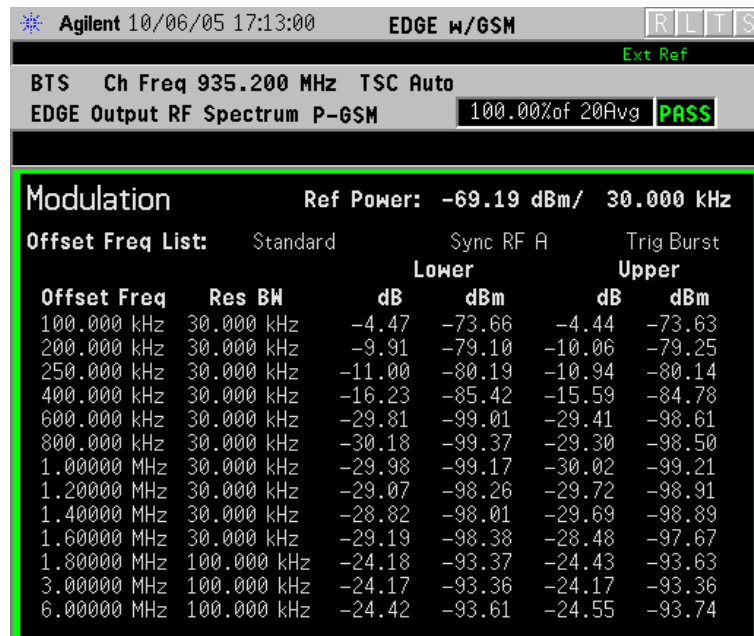

For more details about changing measurement parameters, see [“EDGE Output RF Spectrum Measurement Keys”](#) on page 166 and [“EDGE Output RF Spectrum Measurement Concepts”](#) on page 549.

If you have a problem, and get an error message, see [“Interpreting Error Codes”](#) on page 137.

EDGE Tx Band Spur Measurements

This section explains how to make an EDGE Tx Band Spur measurement on an EDGE base station (BTS). Good measurement results verify that the transmitter does not transmit undesirable energy into the transmit band. This energy may cause interference for other users of the EDGE system.

NOTE

This measurement is designed for EDGE BTS testing only. For the GSM Output RF Spectrum measurement see “GMSK Transmitter Band Spurious Signal (Tx Band Spur) Measurements” on page 101.

Configuring the Measurement System

This example shows a base station (BTS) under test set up to transmit RF power, and being controlled remotely by a system controller. The transmitting signal is connected to the analyzer RF input port. Connect the equipment as shown.

Figure 2-20

EDGE Transmitter Band Spurious Measurement System

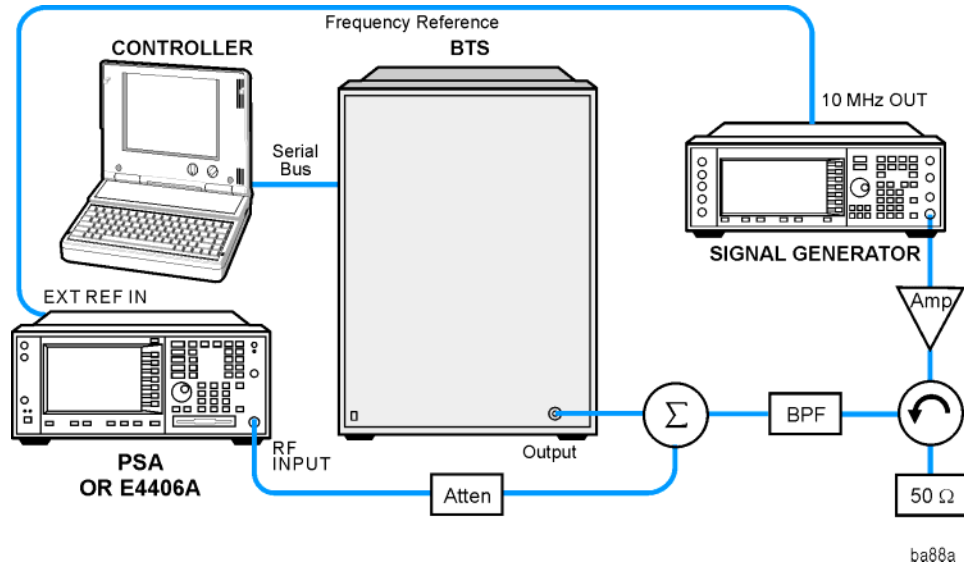

1. Using the appropriate cables, adapters, and circulator, connect the output signal of the BTS to the RF input of the instrument.
2. Connect the base transmission station simulator or signal generator to the BTS through a circulator to initiate a link constructed with sync and pilot channels, if required.
3. Connect a BNC cable between the 10 MHz OUT port of the signal generator and the EXT REF IN port of the instrument.
4. Connect the system controller to the BTS through the serial bus

cable to control the BTS operation.

Setting the BTS (Example)

From the base transmission station simulator and the system controller, set up a call using loopback mode for the BTS to transmit the RF power as follows:

BTS: Symbol Rate: 270.833kbps
Frequency: 935.2000 MHz (ARFCN number 1)
Output Power: -3 dBW (0.5 W)

Measurement Procedure

- Step 1.** Press the **Preset** key to preset the instrument.
- Step 2.** Press the **MODE, GSM (w/EDGE)** keys to enable the GSM with EDGE mode measurements.
- Step 3.** Press the **Mode Setup, Trigger** keys to select a trigger source as described in the section titled “[EDGE Tx Band Spur Measurement Keys](#)” on [page 184](#).
- Step 4.** Press the **FREQUENCY Channel** key to select the desired center frequency or ARFCN as described in the section titled “[FREQUENCY Channel Key Menu](#)” on [page 143](#).
- Step 5.** Press the **Burst Type** key to select the desired burst type as described in the section titled “[FREQUENCY Channel Key Menu](#)” on [page 143](#).
- Step 6.** If your signal of interest contains more than 1 Training Sequence, press the **TSC** key, and select a standard Training Sequence (numbered 0-9) to which the measurement will synchronize. The default setting for **TSC** is **Auto**, which automatically correlates to any one of the standard Training Sequences numbered 0-9. See “[FREQUENCY Channel Key Menu](#)” on [page 143](#).
- Step 7.** Press the **MEASURE, Tx Band Spur** keys to initiate the EDGE Transmitter Band Spurious products measurement.

For more details about changing measurement parameters, see “[EDGE Tx Band Spur Measurement Concepts](#)” on [page 554](#).

If you have a problem, and get an error message, see “[Interpreting Error Codes](#)” on [page 137](#).

Results

Figure 2-21 EDGE Tx Band Spur Result - Upper Adj Segment

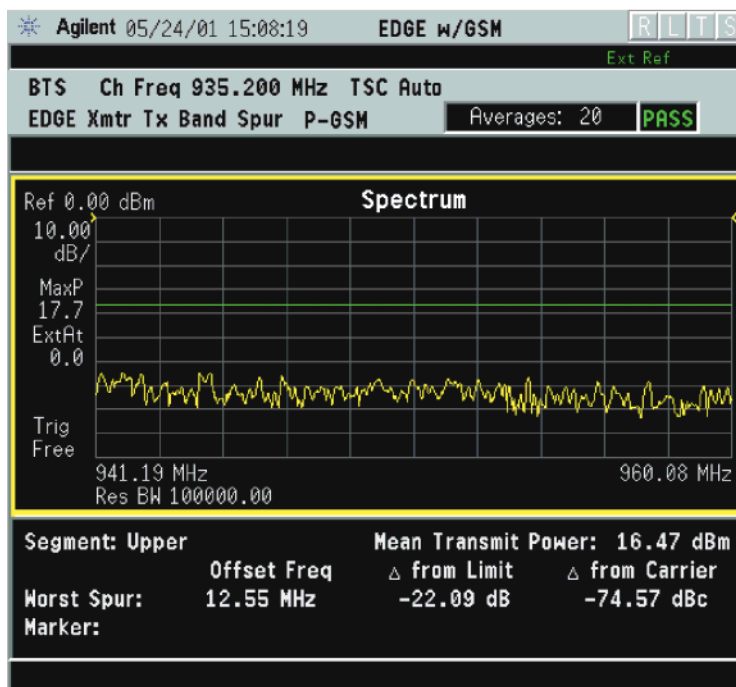

Troubleshooting Hints

Almost any fault in the transmitter circuits can manifest itself in spurious results of one kind or another. Make sure the transmit band is correctly selected and the frequency is either the Bottom, Middle, or Top channel. The “Unexpected carrier frequency (BMT only)” message usually indicates the transmit band and/or carrier frequency is not correct. The “ADC overload -- unexpected carrier frequency” message usually indicates the selected channel frequency does not match the carrier frequency of the signal.

GSMK Output RF Spectrum (ORFS) Measurements

This section explains how to make a GSM Output RF Spectrum measurement on an EDGE base station. This test verifies that the modulation, wideband noise, and power level switching spectra are within limits and do not produce significant interference in the adjacent base transceiver station (BTS) channels.

NOTE This measurement is designed for GSM. For the EDGE Output RF Spectrum measurement see “EDGE Output RF Spectrum (ORFS) Measurements” on page 62.

Configuring the Measurement System

This example shows a base station (BTS) under test set up to transmit RF power, and being controlled remotely by a system controller. The transmitting signal is connected to the analyzer RF input port. Connect the equipment as shown.

Figure 2-22

GSMK ORFS Measurement System

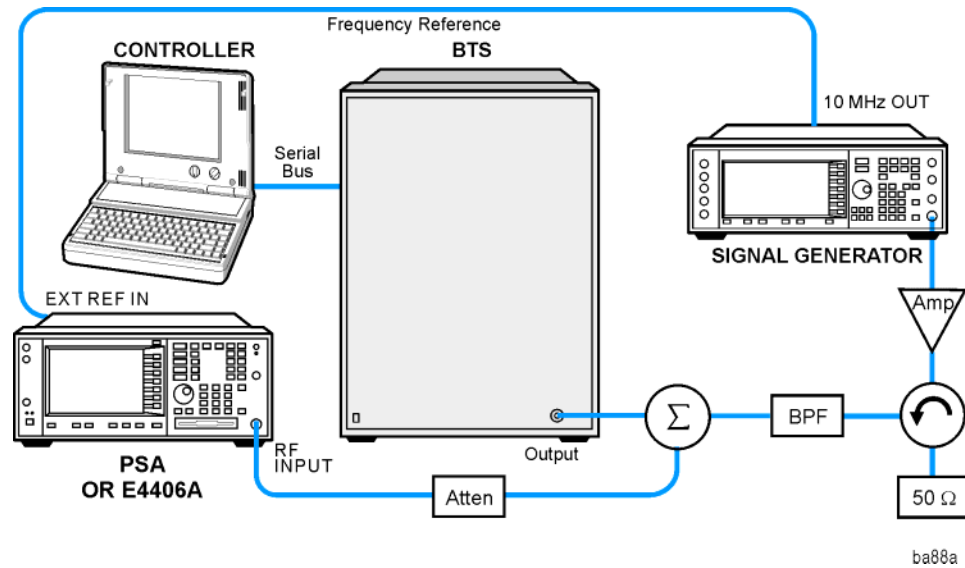

1. Using the appropriate cables, adapters, and circulator, connect the output signal of the BTS to the RF input of the instrument.
2. Connect the base transmission station simulator or signal generator to the BTS through a circulator to initiate a link constructed with sync and pilot channels, if required.
3. Connect a BNC cable between the 10 MHz OUT port of the signal generator and the EXT REF IN port of the instrument.

4. Connect the system controller to the BTS through the serial bus cable to control the BTS operation.

NOTE

If the signal being measured has more than one active slot in a frame, the default RF Burst trigger must be changed, and an external event trigger must be provided to synchronize the frame. Otherwise the measurement may trigger randomly on any burst in an active slot. This is true for all ORFS time domain measurements.

Setting the BTS (Example)

From the base transmission station simulator and the system controller, set up a call using loopback mode for the BTS to transmit the RF power as follows:

BTS: Symbol Rate: 270.833kbps

Frequency: 935.2000 MHz (ARFCN number 1)

Output Power: -3 dBW (0.5 W)

Measurement Procedure

- Step 1.** Press the **Preset** key to preset the instrument.
- Step 2.** Press the **MODE**, **GSM** or **GSM (w/EDGE)** keys to enable the GSM mode measurements.
- Step 3.** Press the **Mode Setup**, **Trigger** keys to select a trigger source as described in the section titled [“EDGE Output RF Spectrum Measurement Keys” on page 166](#).
- Step 4.** Press the **FREQUENCY Channel** key to select the desired center frequency or ARFCN as described in the section titled [“FREQUENCY Channel Key Menu” on page 143](#).
- Step 5.** Press the **Burst Type** key to select the desired burst type as described in the section titled [“FREQUENCY Channel Key Menu” on page 143](#).
- Step 6.** If your signal of interest contains more than 1 Training Sequence, press the **TSC** key, and select a standard Training Sequence (numbered 0-9) to which the measurement will synchronize. The default setting for **TSC** is **Auto**, which automatically correlates to any one of the standard Training Sequences numbered 0-9. See [“FREQUENCY Channel Key Menu” on page 143](#).

Step 7. Press **Meas Setup** and select the **Meas Type** and **Meas Method** for your measurement:

- **Meas Type** - Accesses a menu to choose the measurement that is optimized for the type of spectral distortion being investigated.

Mod & Switch - Performs both Modulation and Switching measurements, which measures the spectrum due to the 0.3 GMSK modulation and noise, and Switching (transient) measurements.

Modulation - Measures the spectrum optimized for distortion due to the 0.3 GMSK modulation and noise.

Switching - Measures the spectrum optimized for distortion due to switching transients (burst ramping).

Full Frame Modulation (FAST)- Improves measurement speed by acquiring a full frame of data prior to performing the FFT calculation. This feature can only be used when all slots in the transmitted frame are active. Use of an external trigger can enhance measurement speed when this feature is used. When **Full Frame Modulation (FAST)** is selected the current measurement defaults to the multi-offset measurement method. Therefore, the **Meas Method** key is grayed out and the **Single Offset** feature is not available.

- **Meas Method** - Accesses a menu to choose the measurement mode.

Multi-Offset - Automatically makes measurements at all offset frequencies in the selected list (**Standard**, **Short**, or **Custom**). Press the **Multi-Offset Freq List** key to select a list of offsets to measure.

Multi-Offset measurements may be made with either **Modulation** or **Switching** measurement types.

Offset measurement results are displayed as tabular data, and may be viewed as either absolute powers in the Modulation Power and Switching Power views, or as powers relative to the margins and limit settings in the Modulation Margin and Limit and Switching Margin and Limit views. See [“Trace/View Key Menu” on page 160](#), and [Figure 2-11 on page 65](#).

Single Offset (Examine) - Makes a measurement at a single offset frequency as set by the **Single Offset Freq** softkey.

Single Offset (Examine) measurements may be made with either **Modulation** or **Switching** measurement types.

Single offset measurement results are displayed in a time domain plot, with the measurement offset shown as a gate by white vertical lines. See [Figure 2-15 on page 69](#).

Swept - Makes a measurement using time-gated spectrum analysis to sweep the analyzer with the gate turned on for the desired portion of the burst only, as set by the **Modulation Ofs** (offsets) & **Limits** menu. The limits mask is applied to the spectrum plot, and the Worst Frequency parameters are displayed. This selection is only available if **Meas Type** is set to **Modulation**. See [Figure 2-18 on page 72](#).

Step 8. Press the **Restart** key to re-initiate a GMSK ORFS measurement if you change the **Meas Type** or **Meas Method**. You can also set **Meas Control** to **Measure Cont** for continuous measurements.

For more details about changing measurement parameters, see “[GMSK Output RF Spectrum Measurement Keys](#)” on page 187 and “[GMSK Output RF Spectrum Measurement Concepts](#)” on page 536.

If you have a problem, and get an error message, see “[Interpreting Error Codes](#)” on page 137.

GMSK ORFS Measurement Results

- **Modulation Power** - When **Meas Method** is set to **Multi-Offset**, and **Meas Type** is set to **Modulation**, or **Mod and Switch**, measurement results may be viewed as absolute powers in tabular form. The data displays offsets from any of the **Multi-Offset Freq List** settings: **Standard**, **Short**, and **Custom**. The **Modulation Power** view is the default view for ORFS measurements. You can select the **Modulation Power** view by pressing **View/Trace**, then **Modulation Power**.

Figure 2-23 GMSK ORFS - Example (Short List) Modulation Power View

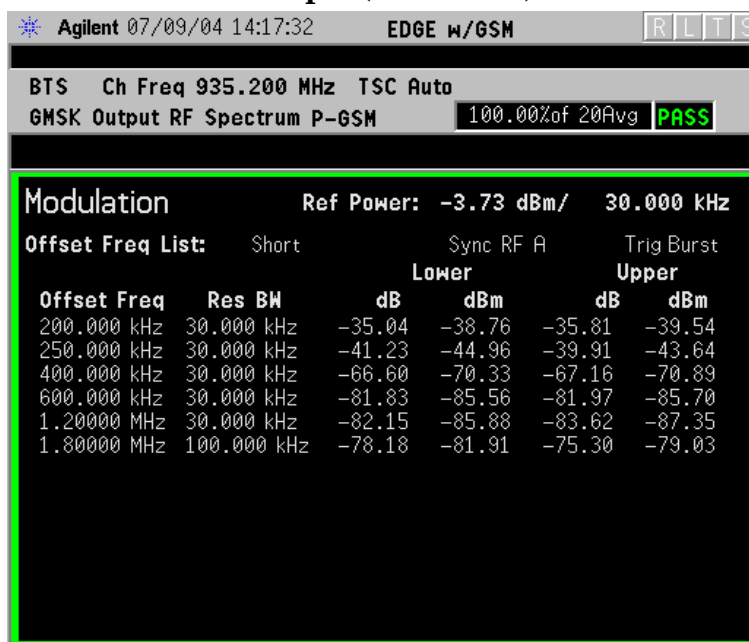

- Modulation Margin & Limits-** When **Meas Method** is set to **Multi-Offset**, and **Meas Type** is set to **Modulation**, or **Mod and Switch**, measurement results may be viewed as relative powers in tabular form. The data displays offsets from any of the **Multi-Offset Freq List** settings: **Standard**, **Short**, and **Custom**, and shows the limit values selected by frequency, with the corresponding measurement result deltas.

You can select the **Modulation Margin and Limits** view by pressing **View/Trace**, then **Modulation Margin and Limits**.

Figure 2-24 GMSK ORFS Result - Example (Short List) Modulation Margin & Limits View

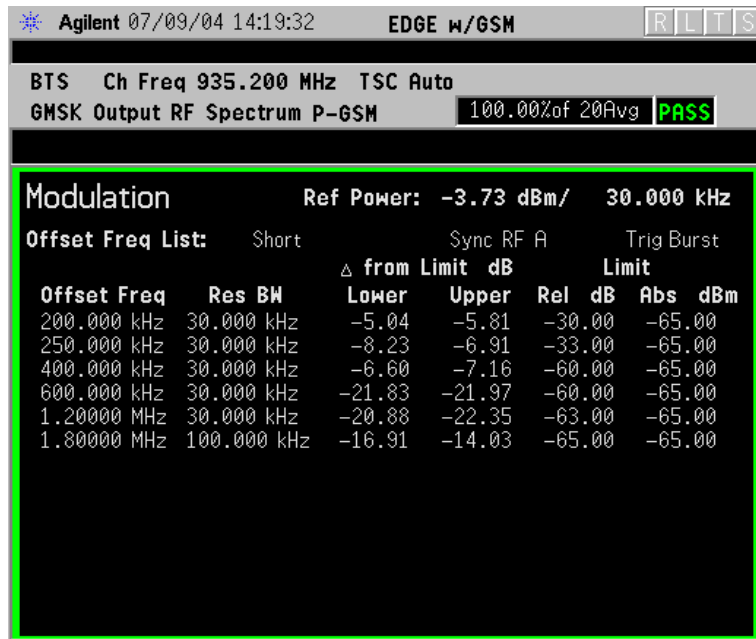

For more details about changing measurement parameters, see [“GMSK Output RF Spectrum Measurement Keys”](#) on page 187 and [“GMSK Output RF Spectrum Measurement Concepts”](#) on page 536.

If you have a problem, and get an error message, see [“Interpreting Error Codes”](#) on page 137.

- **Switching Power** - When **Meas Method** is set to **Multi-Offset**, and **Meas Type** is set to **Switching**, or **Mod and Switch**, measurement results may be viewed as absolute powers in tabular form. The data displays offsets from any of the **Multi-Offset Freq List** settings: **Standard**, **Short**, and **Custom**.

You can select the **Switching Power** view by pressing **View/Trace**, then **Switching Power**.

Figure 2-25 GMSK ORFS Result - Example (Short List) Switching Power View

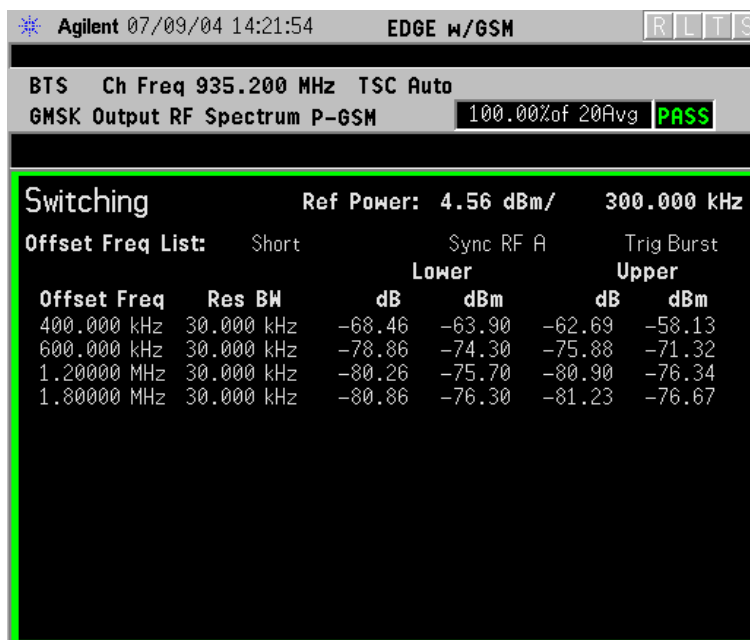

For more details about changing measurement parameters, see “GMSK Output RF Spectrum Measurement Keys” on page 187 and “GMSK Output RF Spectrum Measurement Concepts” on page 536.

If you have a problem, and get an error message, see “Interpreting Error Codes” on page 137.

- **Switching Margin & Limits** - When **Meas Method** is set to **Multi-Offset**, and **Meas Type** is set to **Switching** or **Mod and Switch**, measurement results may be viewed as relative powers in tabular form. The data displays offsets from any of the **Multi-Offset Freq List** settings: **Standard**, **Short**, and **Custom**, and shows the limit values selected by frequency, with the corresponding measurement result deltas.

You can select the **Switching Margin & Limits** view by pressing **View/Trace**, then **Switching Margin & Limits**.

Figure 2-26 GMSK ORFS Result - Switching Margin & Limits View

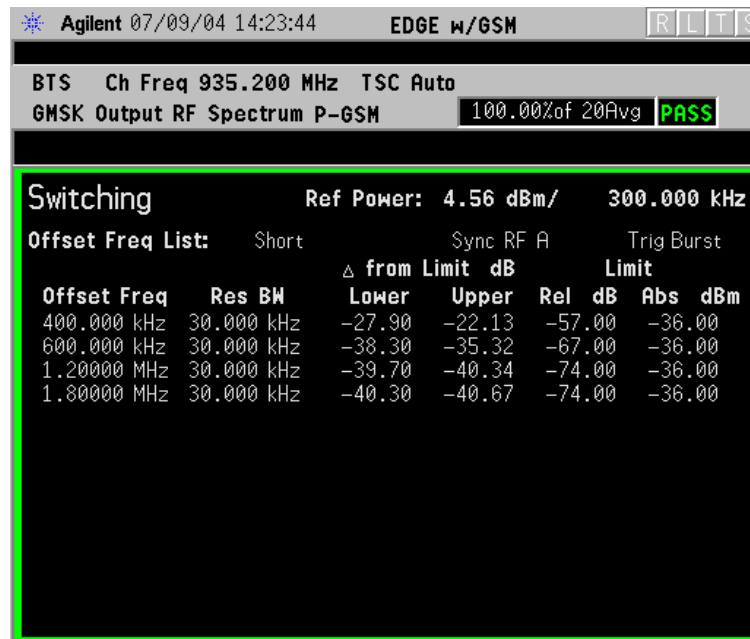

For more details about changing measurement parameters, see “[GMSK Output RF Spectrum Measurement Keys](#)” on page 187 and “[GMSK Output RF Spectrum Measurement Concepts](#)” on page 536.

If you have a problem, and get an error message, see “[Interpreting Error Codes](#)” on page 137.

Single Offset (Examine) - Makes a measurement at a single offset frequency as set by the **Offset Freq** softkey.

Single offset measurement results are displayed as a power waveform in a time domain plot, with the measurement offset shown as a gate by white vertical lines. The red vertical lines represent the additional effective measurement window when **Fast Avg** is **ON** (default setting).

NOTE

The signal being displayed below is the useful part of slot 1, which in this example, is the only active slot in the frame. If any other slots are active, the default RF Burst trigger must be changed, and an external event trigger must be provided to synchronize the frame. Otherwise the measurement may trigger randomly on any burst in an active slot. This is true for all ORFS time domain measurements.

Figure 2-27 GMSK ORFS Result - Modulation Single Offset (Examine) View

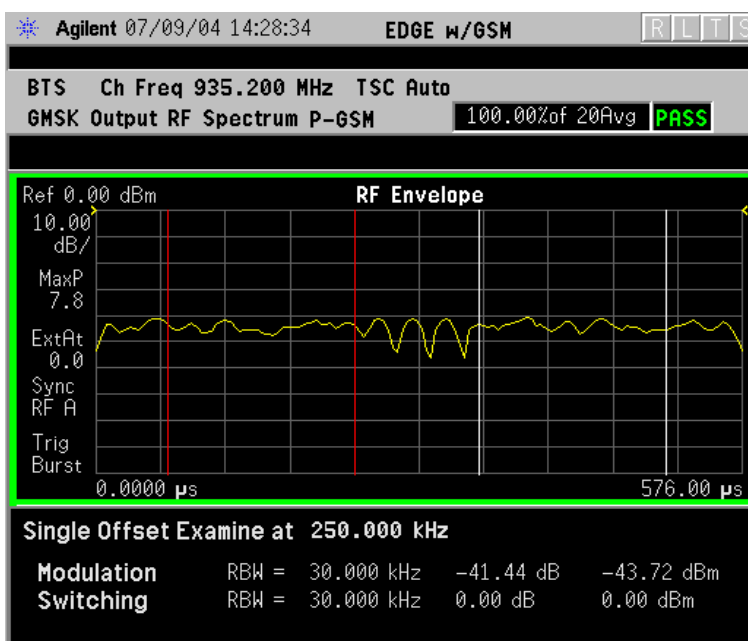

For more details about changing measurement parameters, see [“GMSK Output RF Spectrum Measurement Keys”](#) on page 187 and [“GMSK Output RF Spectrum Measurement Concepts”](#) on page 536.

If you have a problem, and get an error message, see [“Interpreting Error Codes”](#) on page 137.

Switching Single Offset measurement results are displayed in a time domain plot, but the waveform of the entire frame is displayed. In this example, slots 1 and 4 are active. Use the external trigger to maintain frame synchronization. **Fast Avg** is not available for this measurement.

Figure 2-28 GSMK ORFS Result - Switching Single Offset (Examine) View

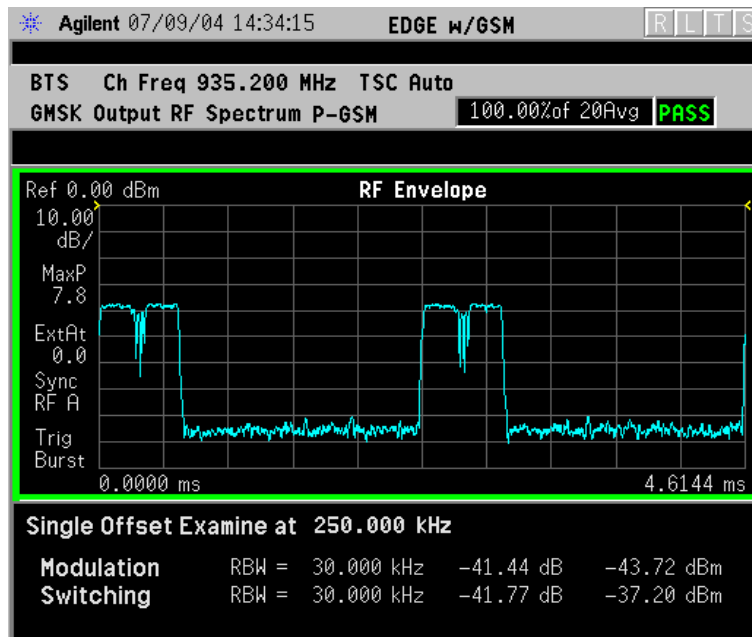

For more details about changing measurement parameters, see “GSMK Output RF Spectrum Measurement Keys” on page 187 and “GSMK Output RF Spectrum Measurement Concepts” on page 536.

If you have a problem, and get an error message, see “Interpreting Error Codes” on page 137.

Combination Modulation and Switching (**Mod & Switch**) Single Offset measurement results are displayed in a time domain plot, but the waveform of the entire frame is displayed. The blue trace is the Switching data and the yellow trace is the Modulation data, with the measurement gates shown.

In this example, slots 1 and 4 are active. Use the external trigger to maintain frame synchronization. **Fast Avg** is not available for this measurement.

Figure 2-29 GMSK ORFS Result - Mod & Switch Single Offset (Examine) View

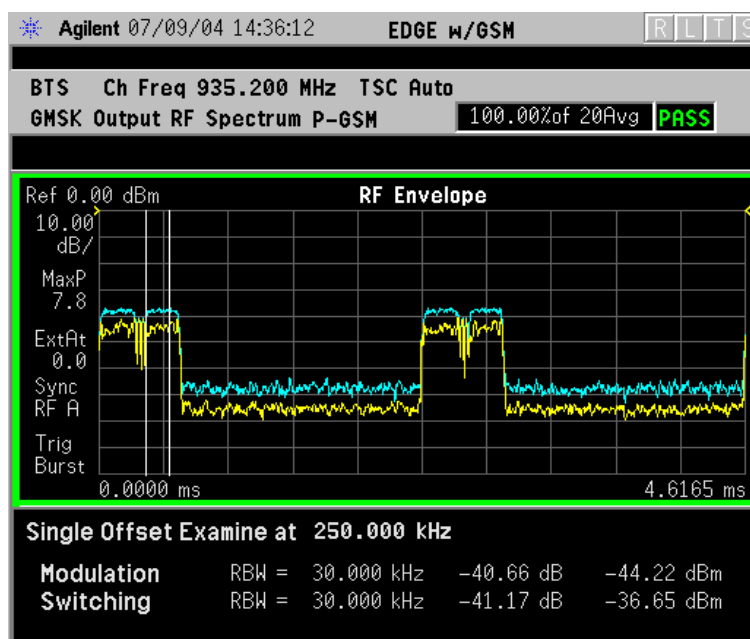

For more details about changing measurement parameters, see “GMSK Output RF Spectrum Measurement Keys” on page 187 and “GMSK Output RF Spectrum Measurement Concepts” on page 536.

If you have a problem, and get an error message, see “Interpreting Error Codes” on page 137.

- **Swept** - When **Meas Type** is set to **Modulation** and **Meas Method** is set to **Swept**, measurement results may be viewed in the spectrum domain, with the limit mask applied to the spectrum plot, and the Worst Frequency parameters displayed. This selection is only available if **Meas Type** is set to **Modulation**.

Figure 2-30 GSMK ORFS Result - Example Modulation Swept View

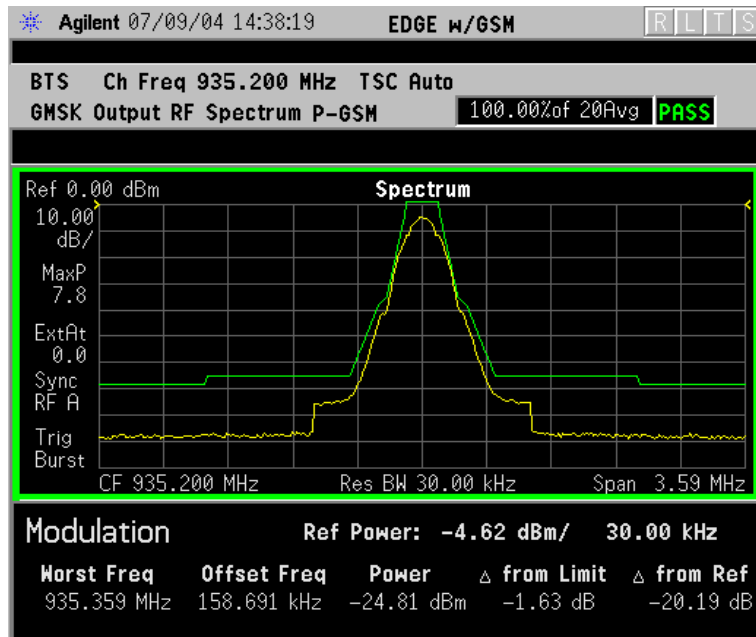

For more details about changing measurement parameters, see “GSMK Output RF Spectrum Measurement Keys” on page 187 and “GSMK Output RF Spectrum Measurement Concepts” on page 536.

If you have a problem, and get an error message, see “Interpreting Error Codes” on page 137.

- **Full Frame Mode (FAST)** - When **Meas Method** is set to **Multi-Offset**, and **Meas Type** is set to **Full Frame Mode (FAST)**, measurement results may be viewed as relative and absolute powers in tabular form. The data displays offsets from any of the **Multi-Offset Freq List** settings: **Standard**, **Short**, and **Custom**.

To measure **Full Frame Mode (FAST)**, all slots in the frame must be active. In the example below, slots 6 and 7 were inactive.

Figure 2-31 GMSK ORFS Result - Full Frame Modulation (FAST) View

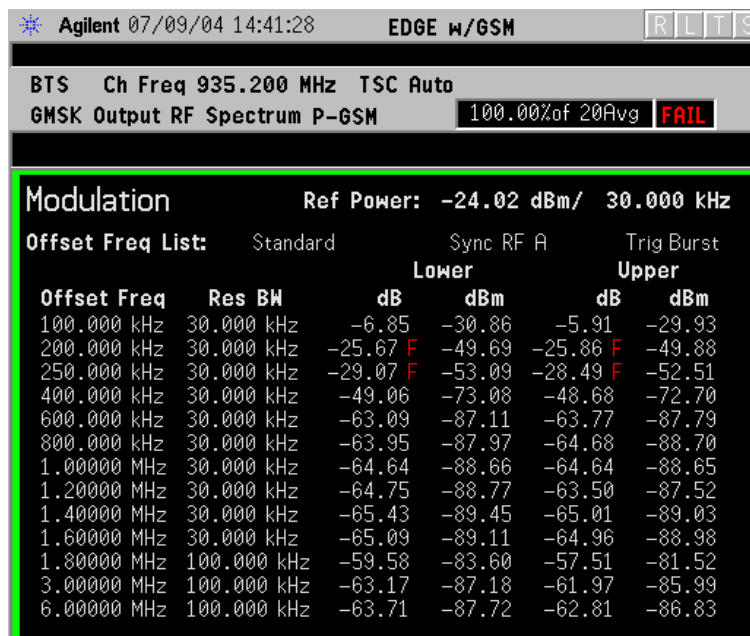

For more details about changing measurement parameters, see [“GMSK Output RF Spectrum Measurement Keys”](#) on page 187 and [“GMSK Output RF Spectrum Measurement Concepts”](#) on page 536.

If you have a problem, and get an error message, see [“Interpreting Error Codes”](#) on page 137.

GMSK Phase and Frequency Error Measurements

This section explains how to make a GMSK Phase and Frequency Error measurement on a GSM base station (BTS). Good measurement results Verify modulation quality of the 0.3 GMSK signal for GSM systems. The modulation quality indicates the carrier to noise performance of the system, which is critical for mobiles with low signal levels, at the edge of a cell, or under difficult fading or Doppler conditions.

NOTE This measurement is designed for GSM only.

Configuring the Measurement System

This example shows a base station (BTS) under test set up to transmit RF power, and being controlled remotely by a system controller. The transmitting signal is connected to the analyzer RF input port. Connect the equipment as shown.

Figure 2-32

GMSK Phase and Frequency Measurement System

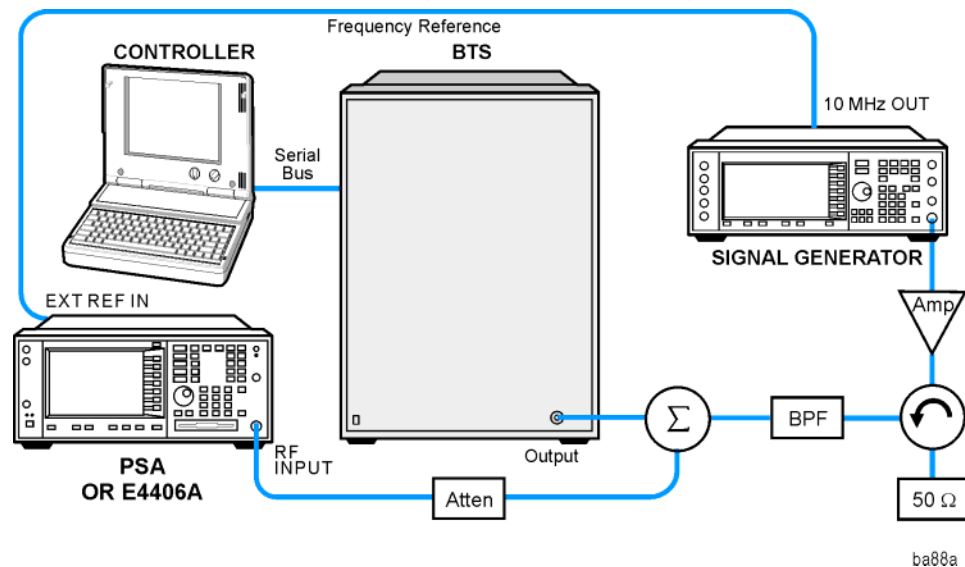

1. Using the appropriate cables, adapters, and circulator, connect the output signal of the BTS to the RF input of the instrument.
2. Connect the base transmission station simulator or signal generator to the BTS through a circulator to initiate a link constructed with sync and pilot channels, if required.
3. Connect a BNC cable between the 10 MHz OUT port of the signal generator and the EXT REF IN port of the instrument.
4. Connect the system controller to the BTS through the serial bus

cable to control the BTS operation.

Setting the BTS (Example)

From the base transmission station simulator and the system controller, set up a call using loopback mode for the BTS to transmit the RF power as follows:

BTS: Symbol Rate: 270.833kbps
Frequency: 935.2000 MHz (ARFCN number 1)
Output Power: -3 dBW (0.5 W)

Measurement Procedure

- Step 1.** Press the **Preset** key to preset the instrument.
- Step 2.** Press the **MODE, GSM (w/EDGE)** keys to enable the GSM with EDGE mode measurements.
- Step 3.** Press the **Mode Setup, Trigger** keys to select a trigger source as described in the section titled “[GMSK Phase and Frequency Error Measurement Keys](#)” on page 197.
- Step 4.** Press the **FREQUENCY Channel** key to select the desired center frequency or ARFCN as described in the section titled “[FREQUENCY Channel Key Menu](#)” on page 143.
- Step 5.** Press the **Burst Type** key to select the desired burst type as described in the section titled “[FREQUENCY Channel Key Menu](#)” on page 143.
- Step 6.** If your signal of interest contains more than 1 Training Sequence, press the **TSC** key, and select a standard Training Sequence (numbered 0-9) to which the measurement will synchronize. The default setting for **TSC** is **Auto**, which automatically correlates to any one of the standard Training Sequences numbered 0-9. See “[FREQUENCY Channel Key Menu](#)” on page 143.
- Step 7.** Press the **MEASURE, GMSK Phase & Freq** keys to initiate the Phase and Frequency Error measurement.

Figure 2-33 GSMK Phase and Frequency Error Result - Quad View (Default)

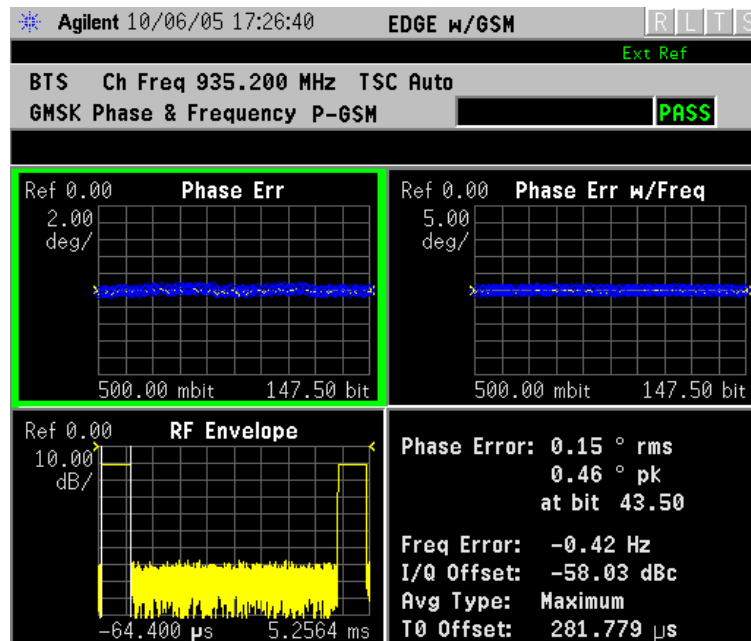

Step 8. Press the **Next Window, Zoom** keys to expand the Phase Error with Frequency graph.

Figure 2-34 GSMK Phase and Frequency Error Result - Phase Error View

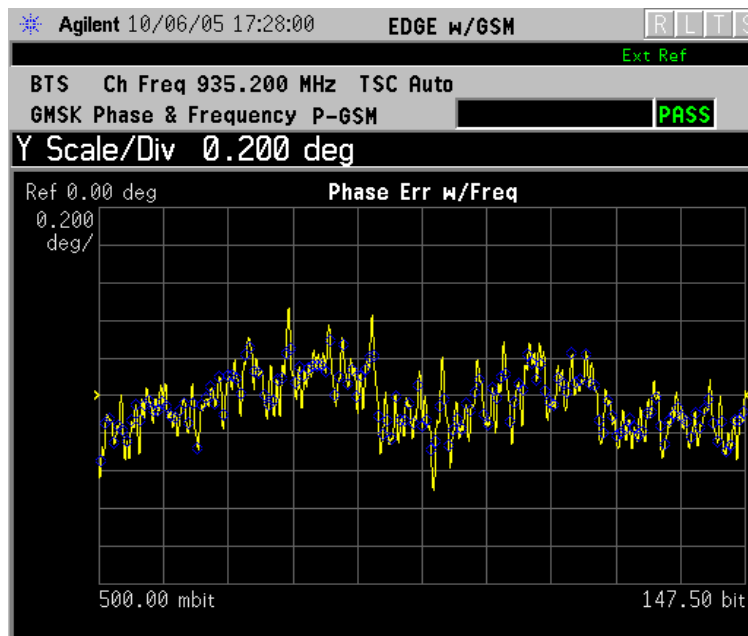

Step 9. Press the **Next Window** key to expand the RF Envelope graph. The horizontal scale in this graph is Time, not bits, as in previous graphs.

Figure 2-35 GSMK Phase and Frequency Error Result - RF Envelope View

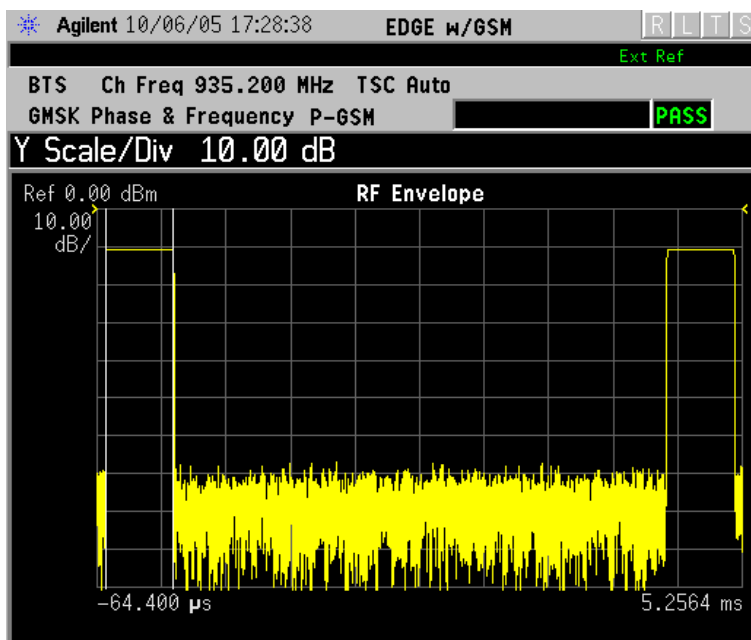

Step 10. Press the **View/Trace, I/Q Measured Polar Vector** key to view the Polar plot of vector data and the Phase and Frequency Error summaries.

Figure 2-36 GSMK Phase and Frequency Error Result - Polar View

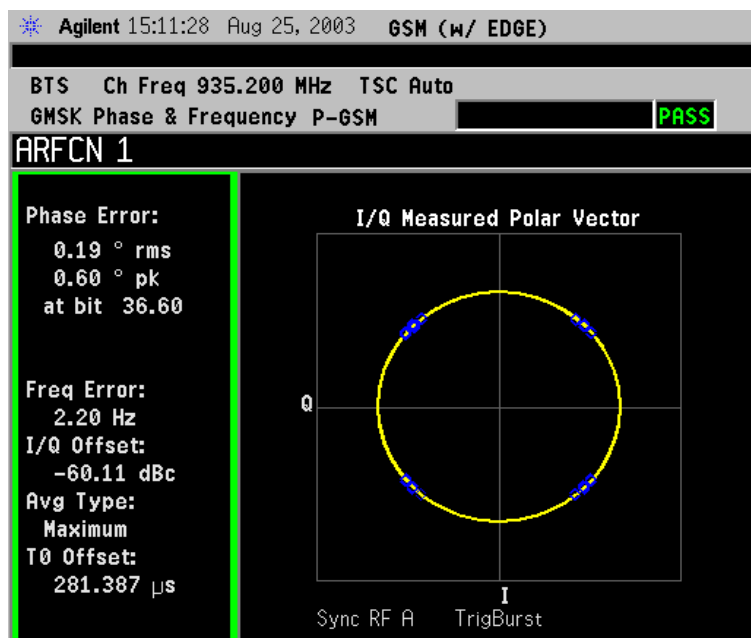

Step 11. Press the **View/Trace, GMSK Phase Error, Zoom** key to the Phase Error vs. Frequency graph.

NOTE The demodulated bits in this display are Symbol State bits, and do not represent encoded message data.

Figure 2-37 **GMSK Phase and Frequency Error Result - Data Bits**

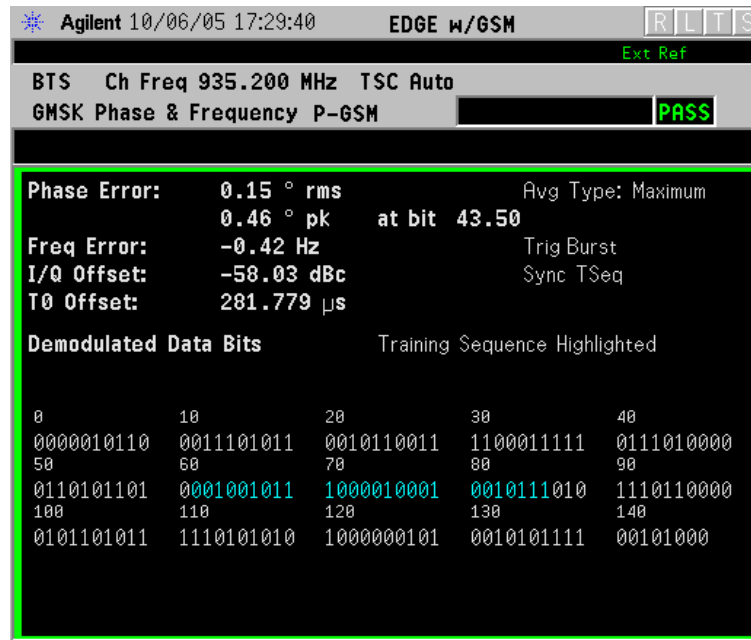

For More Information

For more details about changing measurement parameters, see [“GMSK Phase and Frequency Error Measurement Concepts”](#) on page 533.

If you have a problem, and get an error message, see [“Interpreting Error Codes”](#) on page 137.

Troubleshooting Hints

Poor phase error indicates a problem with the I/Q baseband generator, filters, or modulator in the transmitter circuitry. The output amplifier in the transmitter can also create distortion that causes unacceptably high phase error. In a real system, poor phase error reduces the ability of a receiver to correctly demodulate, especially in marginal signal conditions. This ultimately affects range.

Occasionally, a Phase and Frequency Error measurement may fail the prescribed limits at only one point in the burst, for example at the beginning. This could indicate a problem with the transmitter power ramp or some undesirable interaction between the modulator and power amplifier.

GMSK Power vs. Time (PvT) Measurements

This section explains how to make a GMSK Power versus Time (PvT) measurement on a GSM base station (BTS). Good PvT measurement results verify that the transmitter output power has the correct amplitude, shape, and timing for the GSM format.

NOTE This measurement is designed for GSM. For the EDGE PvT measurement see “EDGE Power vs. Time (PVT) Measurements” on page 50.

Configuring the Measurement System

This example shows a base station (BTS) under test set up to transmit RF power, and being controlled remotely by a system controller. The transmitting signal is connected to the analyzer RF input port. Connect the equipment as shown.

Figure 2-38 GMSK Pwr vs Time Measurement System

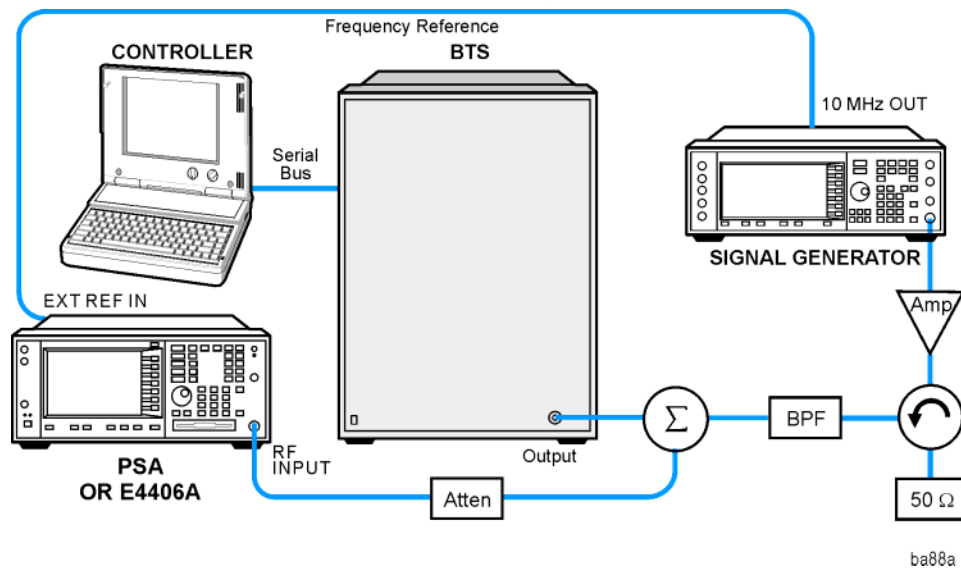

1. Using the appropriate cables, adapters, and circulator, connect the output signal of the BTS to the RF input of the instrument.
2. Connect the base transmission station simulator or signal generator to the BTS through a circulator to initiate a link constructed with sync and pilot channels, if required.
3. Connect a BNC cable between the 10 MHz OUT port of the signal generator and the EXT REF IN port of the instrument.
4. Connect the system controller to the BTS through the serial bus cable to control the BTS operation.

Setting the BTS (Example)

From the base transmission station simulator and the system controller, set up a call using loopback mode for the BTS to transmit the RF power as follows:

BTS: Symbol Rate: 270.833kbps
Frequency: 935.2000 MHz (ARFCN number 1)
Output Power: -3 dBW (0.5 W)

Measurement Procedure

- Step 1.** Press the **Preset** key to preset the instrument.
- Step 2.** Press the **MODE, GSM (w/EDGE)** keys to enable the EDGE mode measurements.
- Step 3.** Press the **Mode Setup, Trigger** keys to select a trigger source as described in the section titled [“GMSK Power vs. Time Measurement Keys” on page 204](#).
- Step 4.** Press the **Radio, Band** keys to select the desired band. This determines the frequency and band-related presets. Our example uses the default setting, **P-GSM**.
- Step 5.** Press the **FREQUENCY Channel** key to select the desired center frequency or ARFCN as described in the section titled [“FREQUENCY Channel Key Menu” on page 143](#).
- Step 6.** Press the **Burst Type** key to select the desired burst type as described in the section titled [“FREQUENCY Channel Key Menu” on page 143](#).
- Step 7.** If your signal of interest contains more than 1 Training Sequence, press the **TSC** key, and select a standard Training Sequence (numbered 0-7) to which the measurement will synchronize. The default setting for **TSC** is **Auto**, which automatically correlates to any one of the standard Training Sequences numbered 0-7. See [“FREQUENCY Channel Key Menu” on page 143](#).
- Step 8.** Press the **MEASURE, GMSK Pwr vs Time** keys to initiate the EDGE Power vs Time measurement.
- Step 9.** Press the **Meas Setup, More, Pwr Ctrl Lvl** keys to select the desired power control level. Our example uses the default setting **0**.

For more details about changing measurement parameters, see [“GMSK Power vs. Time Measurement Concepts” on page 527](#)

If you have a problem, and get an error message, see [“Interpreting Error Codes” on page 137](#).

Results

The views available under the **View/Trace** menu are **Burst**, **Rise & Fall**, and **Multi-Slot**.

Information shown in the left margin of the displays include:

- **MaxP** - This is total input power allowed for the measurement. This value is coupled to the internal RF **Input Atten** setting.
- **ExtAt** - This value reflects the **External RF Atten** setting.
- **Sync** - The **Burst Sync** setting used in the current measurement
- **Trig** - The **Trigger Source** setting used in the current measurement

The **Mean Transmit Power** is displayed at the bottom left of the Burst and Rise & Fall views:

- **Mean Transmit Power** - This is the RMS average power across the “useful” part of the burst, or the 147 bits centered on the transition from bit 13 to bit 14 (the “T0” time point) of the 26 bit training sequence. An RMS calculation is performed and displayed regardless of the averaging mode selected for the trace data.

If Averaging = ON, the result displayed is the RMS average power of all bursts measured. If Averaging = OFF, the result is the RMS average power of the single burst measured. This is a different measurement result from Mean Transmit Pwr, below.

The **Current Data** displayed at the bottom of the Burst and Rise & Fall views include:

- **Mean Transmit Pwr** - This result appears only if Averaging = ON. It is the RMS average of power across the “useful” part of the burst, for the current burst only. If a single measurement of “n” averages has been completed, the result indicates the Mean Transmit Pwr of the last burst. The RMS calculation is performed and displayed regardless of the averaging mode selected for the trace data. This is a different measurement result from Mean Transmit Power, above.
- **Max Pt.** - Maximum signal power point in dBm
- **Min Pt.** - Minimum signal power point in dBm
- **Burst Width** - Time duration of burst at -3 dB power point (half-power)
- **Mask Ref Pwr Midamble** - The Mask Reference Power is the average power in dBm of the middle 16 symbols in the midamble. The times displayed are the corresponding start and stop times of the middle 16 symbols.
- **1st Error Pt** - (Error Point) The time (displayed in ms or μ s) indicates the point on the X Scale where the first failure of a signal

was detected. Use a marker to locate this point in order to examine the nature of the failure.

The table in the lower portion of the multi-slot view shows the output power in dBm for each timeslot, as determined by the integer (1 to 8) entered in the **Meas Setup, Meas Time** setting. Output power levels are presented for the active slots. A dashed line appears for any slot that is inactive. The timeslot that contains the burst of interest is highlighted in blue.

Figure 2-39 GMSK Power vs. Time Result - Burst View

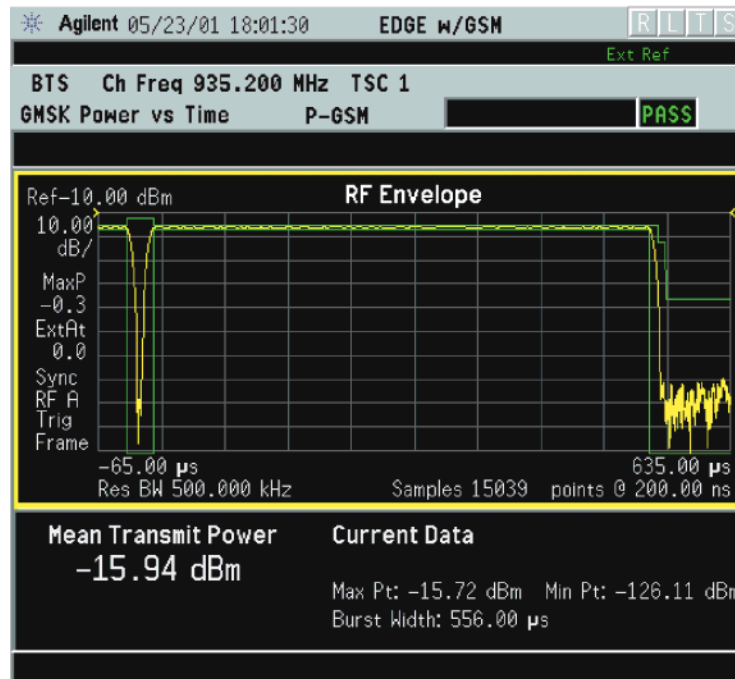

Figure 2-40 GMSK Power vs. Time Result - Rise & Fall View

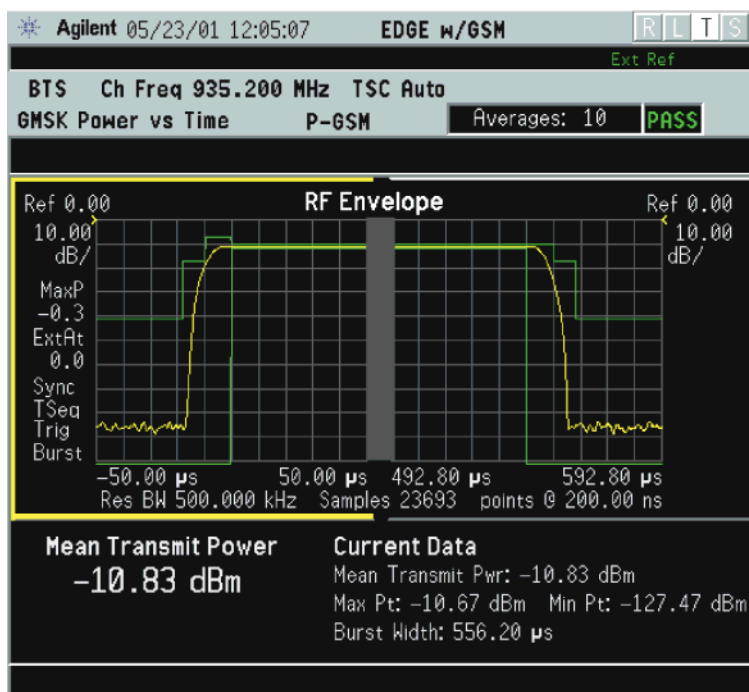

Figure 2-41 GMSK Power vs. Time Result - Multi-Slot View (5 slots shown)

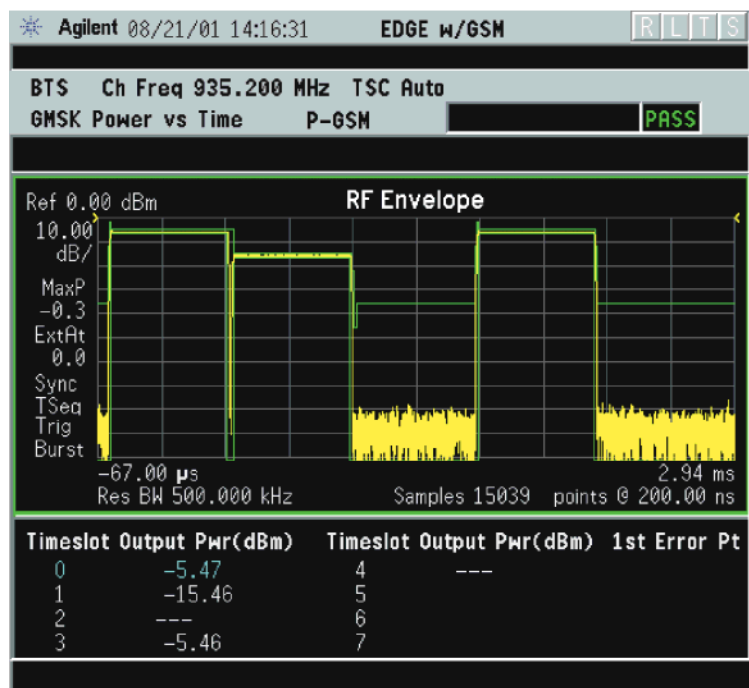

Figure 2-42 GPRS Power vs. Time Result - Multi-Slot View (2 slots shown)

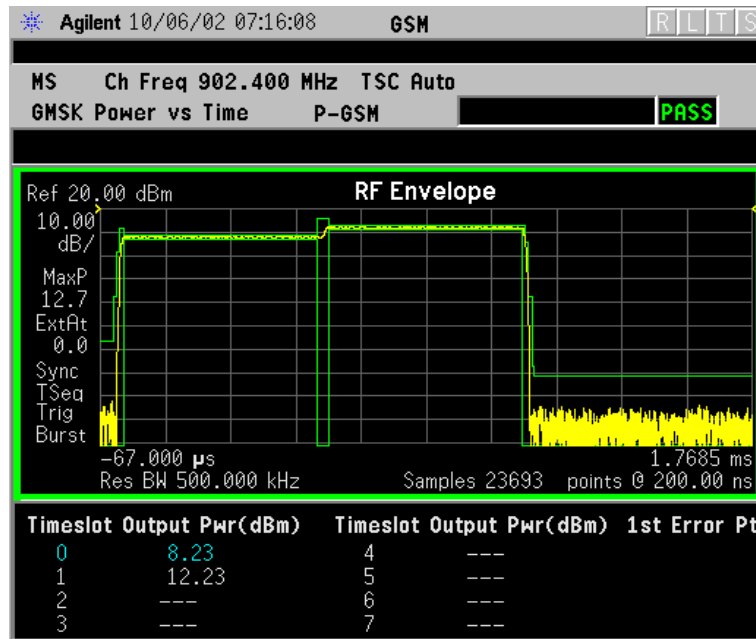
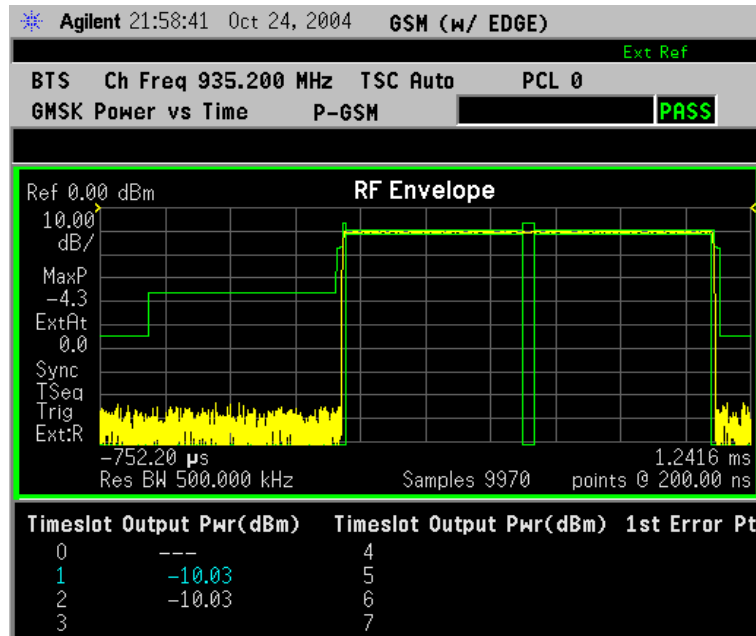

Figure 2-43 GSMK PvT Result - Custom Limit Mask Example of Two Consecutive Bursts



For more information on making measurements of two consecutive bursts, including the SCPI commands used to make the measurement, refer to the section in the Programming Commands chapter. See the section [“GSMK PvT Custom Limit Mask Example of Two Consecutive Bursts”](#) on page 473.

Troubleshooting Hints

If a transmitter fails the Power vs. Time measurement this usually indicates a problem with the units output amplifier or leveling loop.

GMSK Transmitter Band Spurious Signal (Tx Band Spur) Measurements

This section explains how to make a GMSK Tx Band Spur measurement on a GSM base station (BTS). Good measurement results verify that the transmitter does not transmit undesirable energy into the transmit band. If undesirable energy is present, it may cause interference for other users of the GSM system.

NOTE This measurement is designed for GSM BTS testing only. For the EDGE Tx Band Spur measurement see “EDGE Tx Band Spur Measurements” on page 74.

Configuring the Measurement System

This example shows a base station (BTS) under test, set up to transmit RF power, and being controlled remotely by a system controller. The signal generator and combiner network is optional. The transmitting signal is connected to the analyzer RF input port.

Figure 2-44 GMSK Transmitter Band Spurious Measurement System

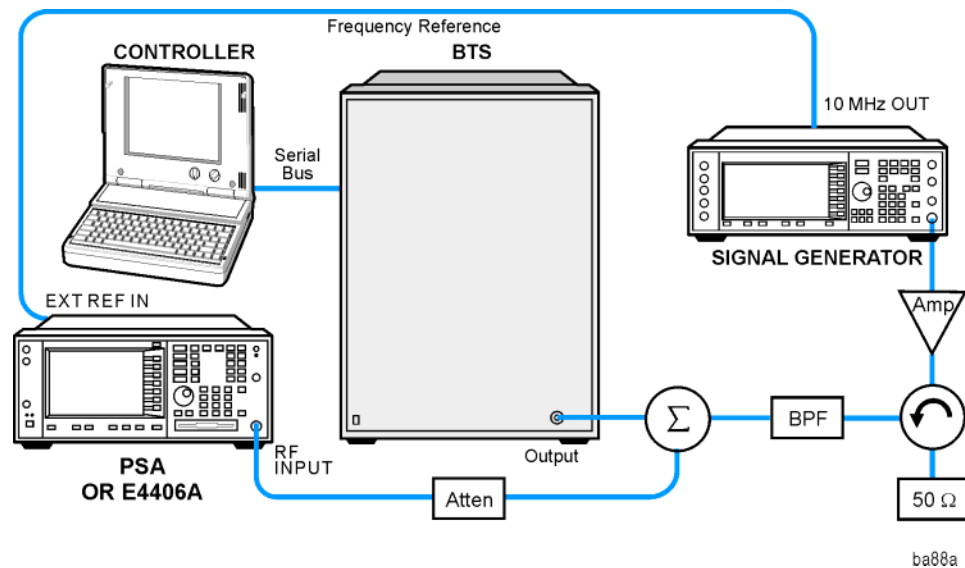

1. Using the appropriate cables, adapters, and circulator, connect the output signal of the BTS to the RF input of the instrument.
2. Connect the base transmission station simulator or signal generator to the BTS through a circulator to initiate a link constructed with sync and pilot channels, if required.
3. Connect a BNC cable between the 10 MHz OUT port of the signal generator and the EXT REF IN port of the instrument.

4. Connect the system controller to the BTS through the serial bus cable to control the BTS operation.

Setting the BTS (Example)

From the base transmission station simulator and the system controller, set up a call using loopback mode for the BTS to transmit the RF power as follows:

BTS: Symbol Rate: 270.833kbps
Frequency: 935.2000 MHz (ARFCN number 1)
Output Power: -3 dBW (0.5 W)

Measurement Procedure

- Step 1.** Press the **Preset** key to preset the instrument.
- Step 2.** Press the **MODE, GSM with EDGE** keys to enable the GSM with EDGE mode measurements.
- Step 3.** Press the **Mode Setup, Trigger** keys to select a trigger source as described in the section titled “[GMSK Tx Band Spur Measurement Keys](#)” on [page 214](#).
- Step 4.** Press the **FREQUENCY Channel** key to select the desired center frequency or ARFCN as described in the section titled “[FREQUENCY Channel Key Menu](#)” on [page 143](#).
- Step 5.** Press the **Burst Type** key to select the desired burst type as described in the section titled “[FREQUENCY Channel Key Menu](#)” on [page 143](#).
- Step 6.** If your signal of interest contains more than 1 Training Sequence, press the **TSC** key, and select a standard Training Sequence (numbered 0-9) to which the measurement will synchronize. The default setting for **TSC** is **Auto**, which automatically correlates to any one of the standard Training Sequences numbered 0-9. See “[FREQUENCY Channel Key Menu](#)” on [page 143](#).
- Step 7.** Press the **MEASURE, GMSK Tx Band Spur** keys to initiate the Transmitter Band Spurious products measurement.

For more details about changing measurement parameters, see “[GMSK Tx Band Spur Measurement Concepts](#)” on [page 540](#)

If you have a problem, and get an error message, see “[Interpreting Error Codes](#)” on [page 137](#).

Results

Figure 2-45

GMSK Tx Band Spur Result - Upper Segment

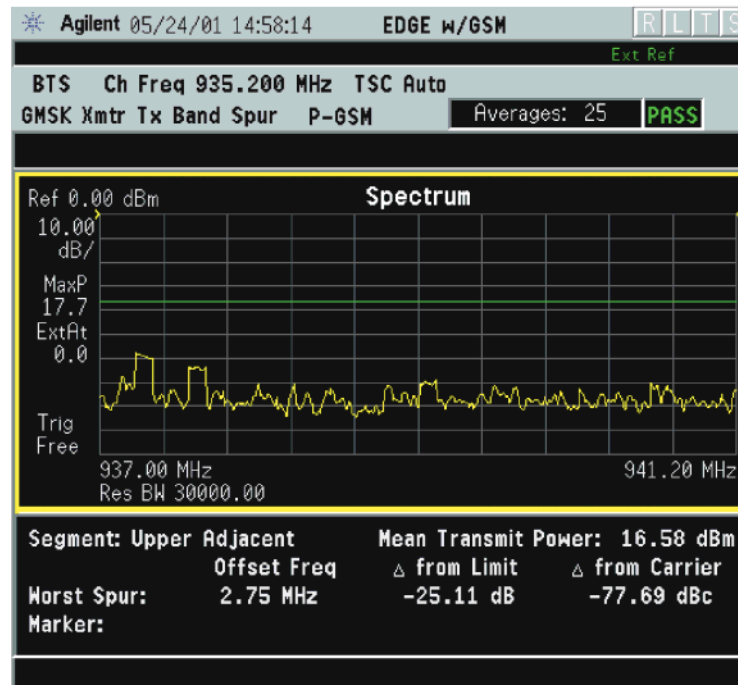

Troubleshooting Hints

Almost any fault in the transmitter circuits can manifest itself as spurious of one kind or another. Make sure the transmit band is correctly selected and the frequency is either the Bottom, Middle, or Top channel. The “Unexpected carrier frequency (BMT only)” message usually indicates the transmit band and/or carrier frequency is not correct. The “ADC overload -- unexpected carrier frequency” message usually indicates the selected channel frequency does not match the carrier frequency of the signal.

Spectrum (Frequency Domain) Measurements

This section explains how to make a frequency domain measurement on a GSM with EDGE base station. An adjacent or an interfering signal can also be applied, if desired, during spectrum measurements.

If installed, you may use PSA Option 122, the 80 MHz Bandwidth Digitizer hardware, or PSA Option 140, the 40 MHz Bandwidth Digitizer hardware to perform spectrum measurements of wideband signals using Basic Mode.

Configuring the Measurement System

This example shows a base station (BTS) under test set up to transmit RF power, and being controlled remotely by a system controller. The transmitting signal is connected to the analyzer RF input port. Connect the equipment as shown.

Figure 2-46 Spectrum Measurement System

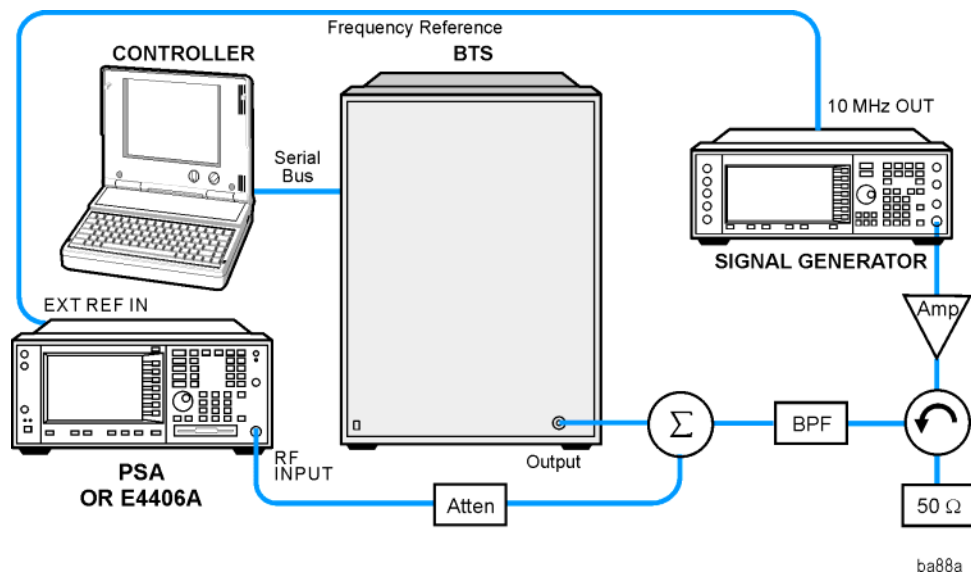

1. Using the appropriate cables, adapters, and circulator, connect the output signal of the BTS to the RF input of the instrument.
2. Connect the base transmission station simulator or signal generator to the BTS through a circulator to initiate a link constructed with sync and pilot channels, if required.
3. Connect a BNC cable between the 10 MHz OUT port of the signal generator and the EXT REF IN port of the instrument.
4. Connect the system controller to the BTS through the serial bus cable to control the BTS operation.

Setting the BTS

From the base transmission station simulator and the system controller, set up a call using loopback mode to allow the BTS to transmit an RF signal.

Measurement Procedure

- Step 1.** Press the **Preset** key to preset the instrument.
- Step 2.** Press the **MODE, GSM (w/ EDGE)** keys to enable the GSM with EDGE Mode measurements.
- Step 3.** To set the measurement center frequency press the **FREQUENCY Channel** key, enter a numerical frequency using the front-panel keypad, and complete the entry by selecting a units key, like **MHz**.
- Step 4.** Press the **SPAN** key, enter a numerical span using the front-panel keypad, and press the **MHz** key to set the measurement span in MHz.
- Step 5.** Press the **MEASURE** key to initiate the spectrum measurement, which is the default measurement for GSM with EDGE.

NOTE

A display with both a Spectrum window and an I/Q Waveform window will appear when you activate a Spectrum measurement. The active window is outlined in green. Changes to **FREQUENCY**, **Span**, or **Amplitude** settings will affect only the active window. Use the **Next Window** key to select a different window, and the **Zoom** key to enlarge a window.

The default display shows both **Current** (yellow trace) and **Average** (blue trace) data. To make viewing the display easier, you can view either the **Current** trace or **Average** separately.

- Press **Trace/View, Trace Display**, and select the trace(s) desired for display.

Figure 2-47 Spectrum Measurement - Spectrum and I/Q Waveform (Default) View

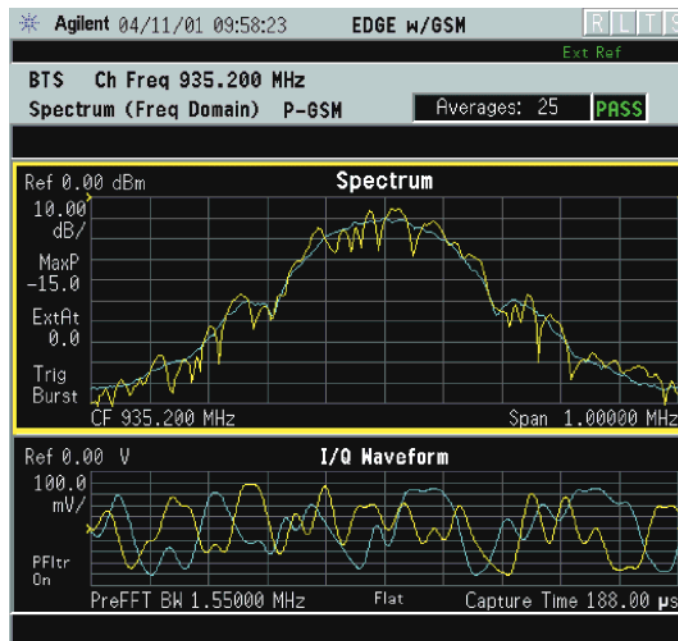

The spectrum measurement result should look like the above figure. The measurement result values are shown in the summary result window.

Step 6. Press the **View/Trace** key to display a menu allowing selection of another measurement result display including the following:

- **Spectrum** - Provides a combination view of the spectrum graph in parameters of power versus frequency with semi-log graticules, and the I/Q waveform graph in parameters of voltage and time. Changes to the frequency span or power will sometimes affect data acquisition. This is equivalent to changing the selected window with the **Next Window** key.

Spectrum (Time Domain) I/Q Waveform - (PSA only) This graph is shown below the Spectrum graph in the default dual-window display. I/Q Waveform provides a view of the I/Q waveform in parameters of voltage versus time in linear scale. Changes to sweep time or resolution bandwidth can affect data acquisition.

Figure 2-48 Spectrum (Time Domain) Measurement - I/Q Waveform Result

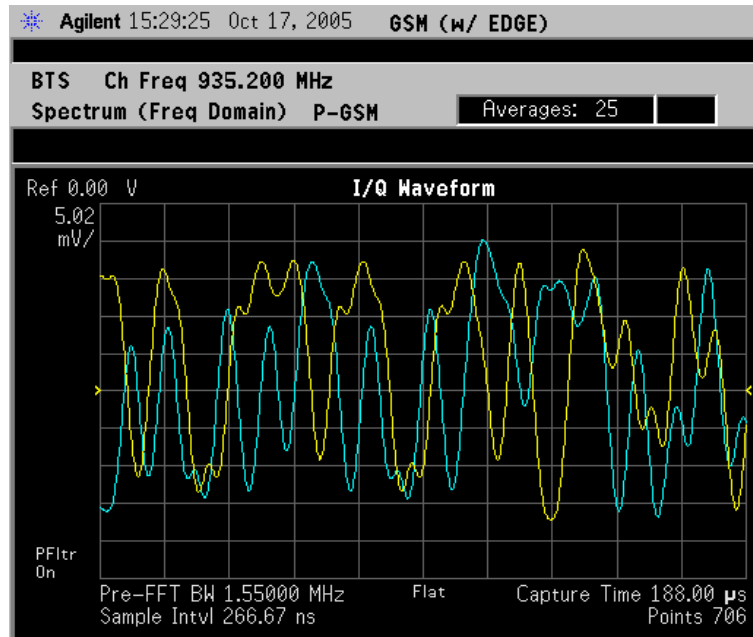

- **Spectrum Linear - (E4406A)** Provides a view of the spectrum graph in parameters of voltage versus frequency in linear scale. Changes to the frequency span or voltage can affect data acquisition.

Figure 2-49 Spectrum Measurement - Linear Spectrum View (for E4406A)

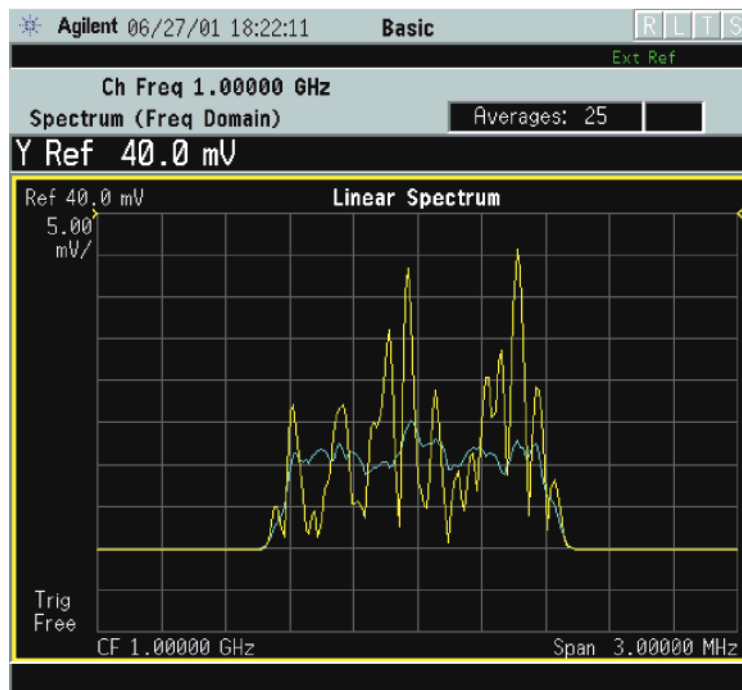
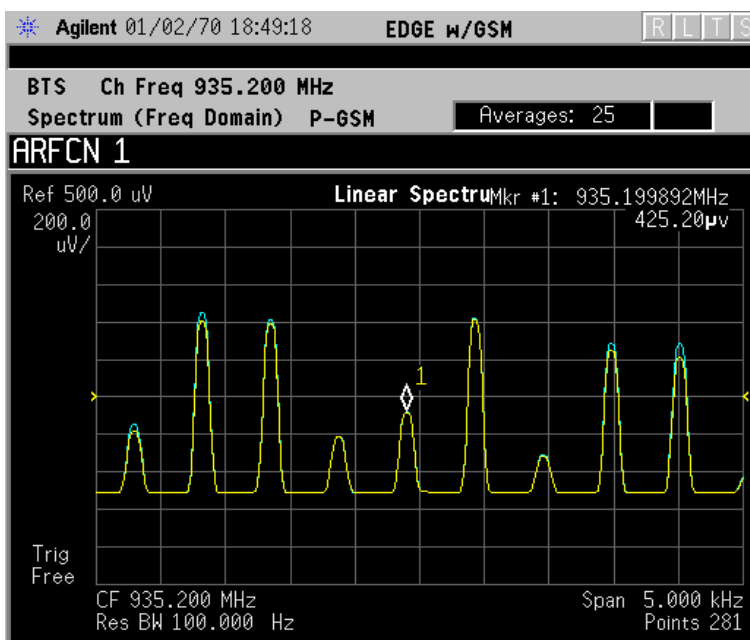

Figure 2-50 Spectrum Measurement - Linear Spectrum View (E4406A)



*Meas Setup: View/Trace = Spectrum Linear,
Span = 5.000 kHz,
Y Scale/Div = 200 μ V, Ref Value = 500.0 μ V,
Others = Factory default settings

*Input signals: -20.00 dBm, EDGE pattern data (PN9)

NOTE

(E4406A) For the widest spans, the I/Q window becomes just “ADC time domain samples”, because the I/Q down-conversion is no longer in effect. This is not the case for E4406A Option B7C if the **Input Port** is set to either **I/Q**, **I only**, or **Q only** and you have connected baseband I/Q signals to the **I/Q INPUT** connectors.

- **I and Q Waveform** - (for E4406A) Provides individual views of the I and Q signal waveform windows in parameters of voltage versus time.

To select the I or Q trace view, press the **Next Window** key at the bottom of the display. The selected window will have a green outline. To view the window full size press the **Zoom** key.

Figure 2-51 Spectrum Measurement - I and Q Waveform View (for E4406A)

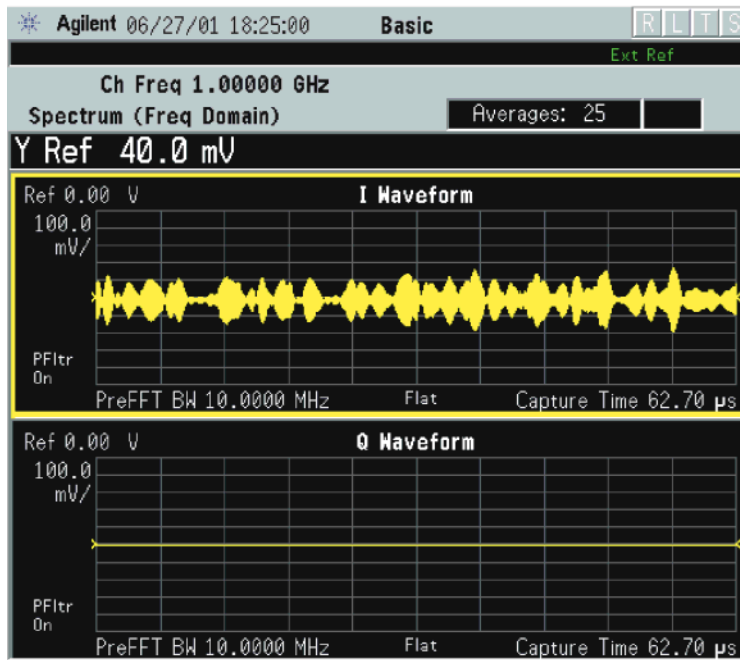
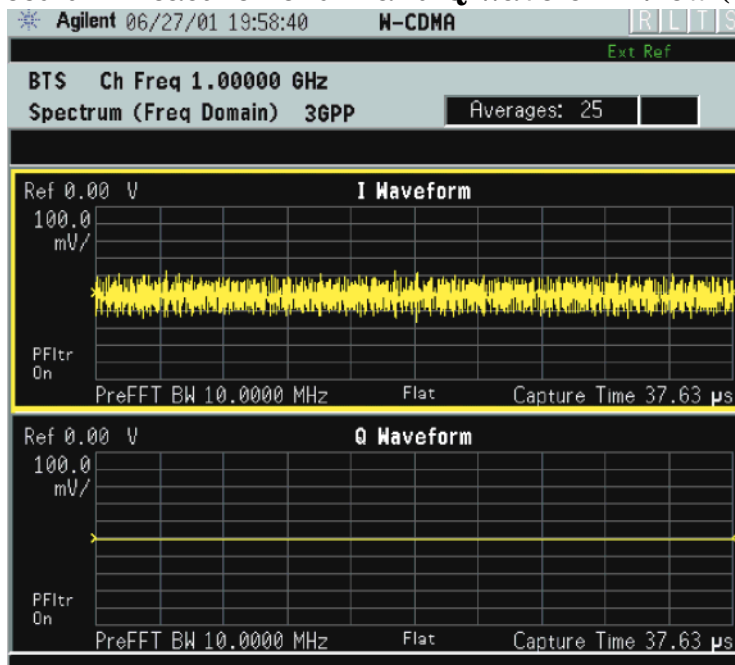

Figure 2-52 Spectrum Measurement - I and Q Waveform View (for E4406A)



*Meas Setup: View/Trace = I and Q Waveform,
Others = Factory default settings

*Input signals: - 10.00 dBm, PCCPCH + SCH

Figure 2-53 Spectrum Measurement - I and Q Waveform View (for E4406A)

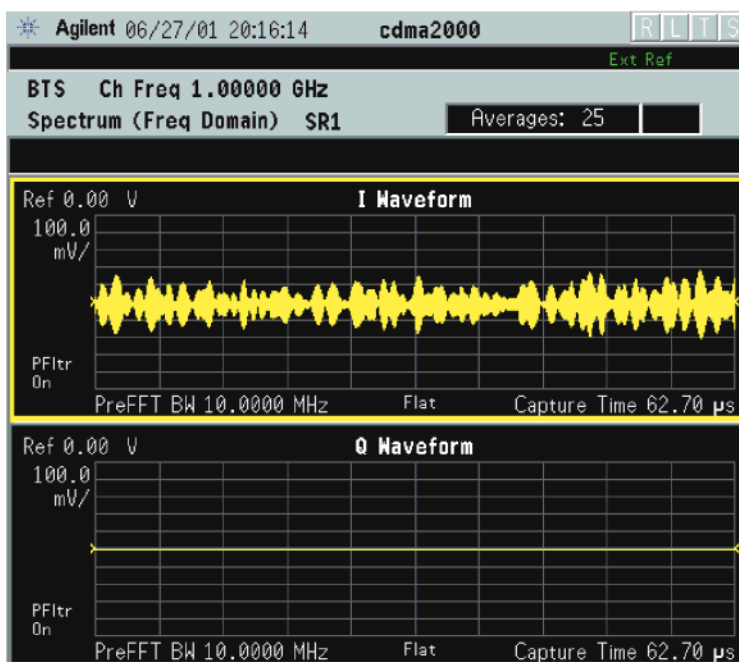

*Meas Setup: View/Trace = I and Q Waveform,
AMPLITUDE Y Scale = 5.00 mV,
Others = Factory default settings

*Input signals: - 10.00 dBm, 9 channels of SR1, cdma2000 Rev 8

Figure 2-54 Spectrum Measurement - I and Q Waveform View (for E4406A)

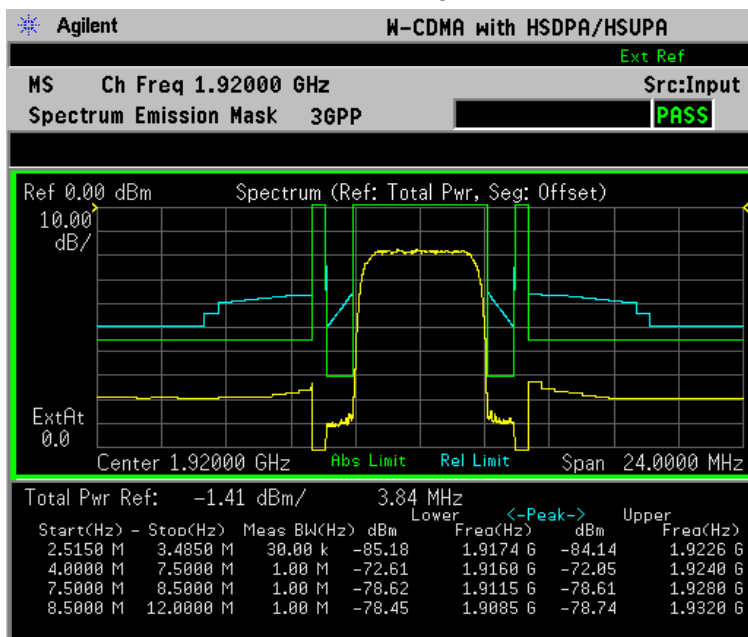

*Meas Setup: View/Trace = I and Q Waveform,
Others = Factory default settings

*Input signals: - 10.00 dBm, Pilot channel, 1xEV-DO

Figure 2-55 Spectrum Measurement - I and Q Waveform View (for E4406A)

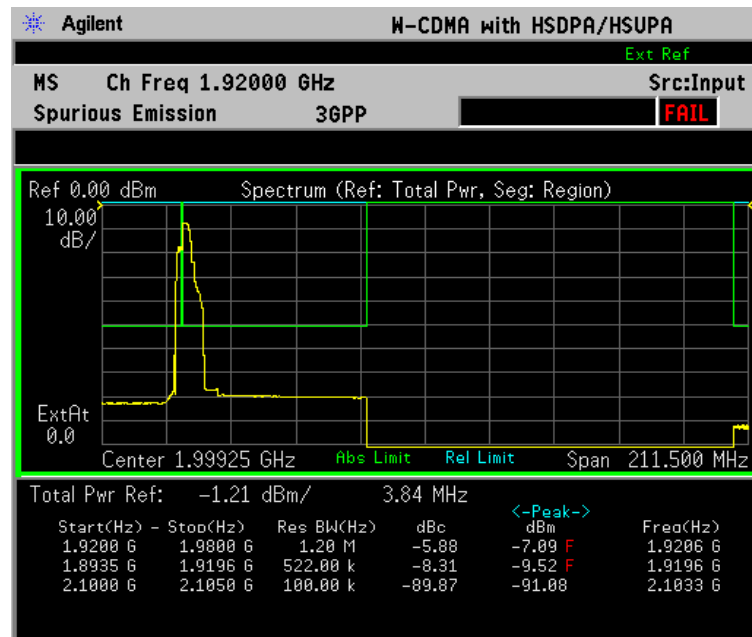

*Meas Setup: View/Trace = I and Q Waveform
Span = 500.000 kHz,
Y Scale/Div = 5.0 mV, Ref Value = 0.0 V,
Others = Factory default settings

*Input signals: - 20.00 dBm, EDGE pattern data (PN9)

- **I/Q Polar** - (for E4406A) Provides a view of the I/Q signal displayed in a polar vector graph.

Figure 2-56 Spectrum Measurement - I/Q Polar View (for E4406A)

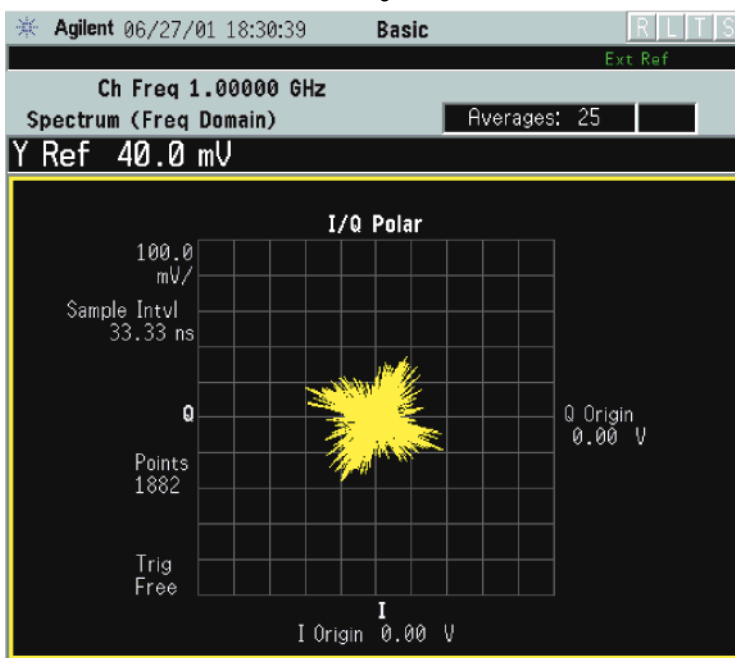
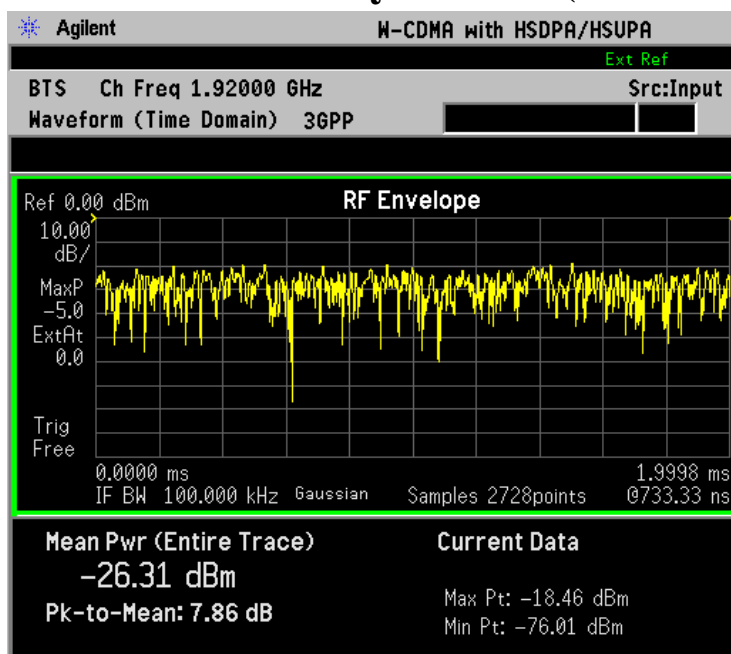

Figure 2-57 Spectrum Measurement - I/Q Polar View (for E4406A)



*Meas Setup: View/Trace = I/Q Polar,
 Others = Factory default settings

*Input signals: - 10.00 dBm, PCCPCH + SCH

Figure 2-58 Spectrum Measurement - I/Q Polar View (for E4406A)

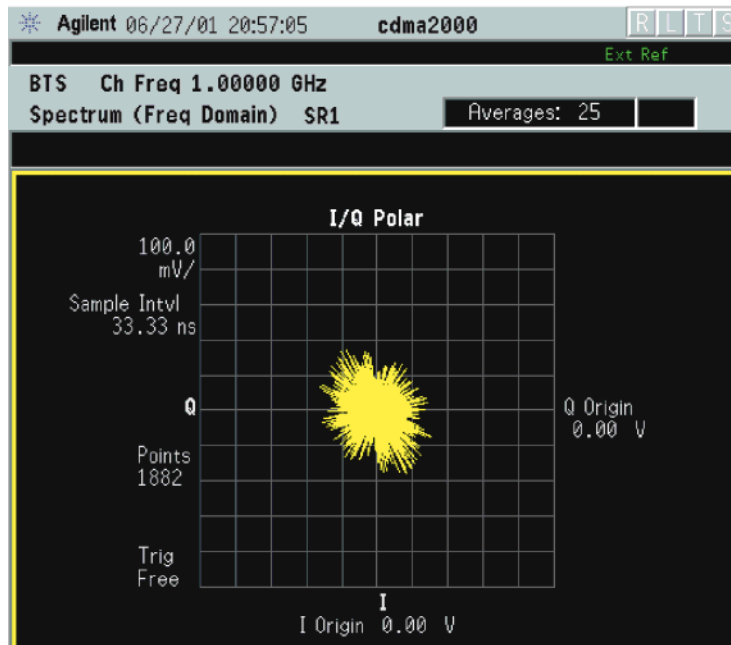

*Meas Setup: View/Trace = I/Q Polar,
Others = Factory default settings

*Input signals: - 10.00 dBm, Pilot channel of SR1, cdma2000 Rev 8

Figure 2-59 Spectrum Measurement - I/Q Polar View (for E4406A)

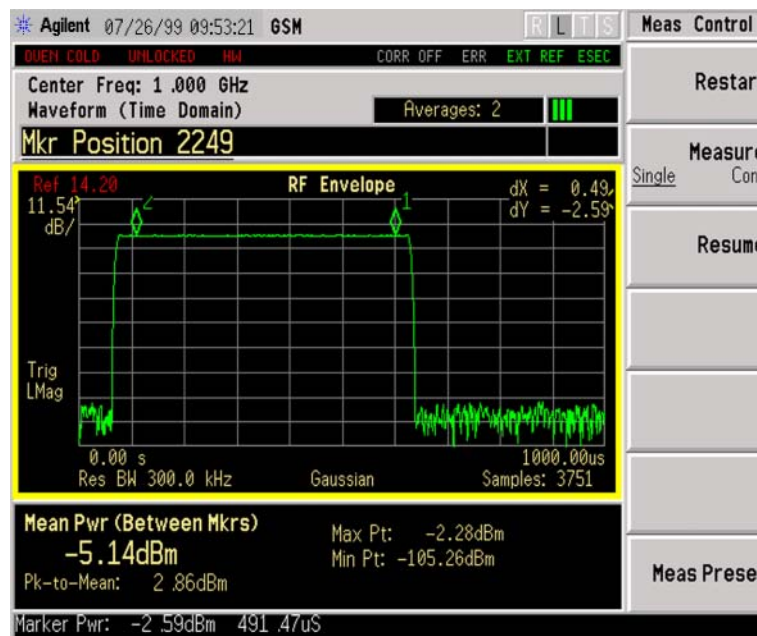

*Meas Setup: View/Trace = I/Q Polar,
Others = Factory default settings

*Input signals: - 10.00 dBm, Pilot channel, 1xEV-DO

Figure 2-60 Spectrum Measurement - I/Q Polar View (E4406A)

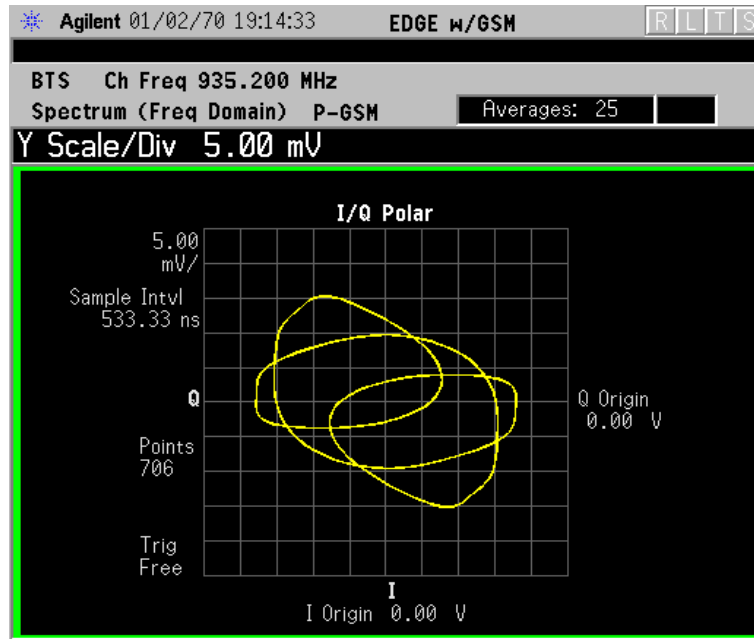

*Meas Setup: View/Trace = I/Q Polar
Span = 500.000 kHz,
Y Scale/Div = 5.0 mV, Ref Value = 0.0 V,
Others = Factory default settings

*Input signals: - 20.00 dBm, EDGE pattern data (PN9)

Step 7. To make a measurement repeatedly, press **Meas Control**, **Measure** to toggle the setting from **Single** to **Cont**.

Step 8. Press the **Meas Setup**, **More (1 of 2)** keys to check the keys available to change the measurement parameters from the default condition.

For more details about changing measurement parameters, see [“Spectrum \(Frequency Domain\) Measurement Concepts”](#) on page 556.

Transmit Power Measurements

This section explains how to make a Transmit Power measurement on a GSM or EDGE base station. This test verifies in-channel power for GSM and EDGE systems. Good measurement results ensure that dynamic power control is optimized, over all system interference is minimized, and mobile station battery life is maximized.

Configuring the Measurement System

The base station (BTS) under test has to be set to transmit the RF power remotely through the system controller. This transmitting signal is connected to the instrument's RF input port. Connect the equipment as shown.

Figure 2-61

Transmit Power Measurement System

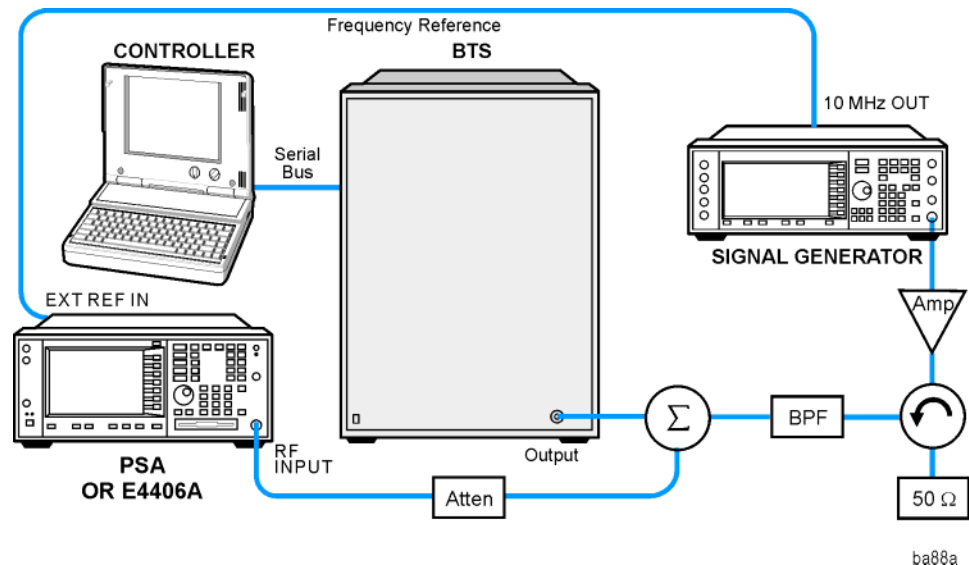

1. Using the appropriate cables, adapters, and circulator, connect the output signal of the BTS to the RF input of the instrument.
2. Connect the base transmission station simulator or signal generator to the BTS through a circulator to initiate a link constructed with sync and pilot channels, if required.
3. Connect a BNC cable between the 10 MHz OUT port of the signal generator and the EXT REF IN port of the instrument.
4. Connect the system controller to the BTS through the serial bus cable to control the BTS operation.

Setting the BTS (Example)

From the base transmission station simulator and the system

controller, set up a call using loopback mode for the BTS to transmit the RF power as follows:

BTS: Symbol Rate: 270.833kbps
Frequency: 935.2000 MHz (ARFCN number 1)
Output Power: -3 dBW (0.5 W)

Measurement Procedure

- Step 1.** Press the **Preset** key to preset the instrument.
- Step 2.** Press the **MODE, GSM (w/EDGE)** keys to enable the GSM with EDGE mode measurements.
- Step 3.** Press the **Mode Setup, Trigger** keys to select a trigger source as described in the section titled [“Transmit Power Measurement Keys” on page 234](#).
- Step 4.** Press the **FREQUENCY Channel** key to select the desired center frequency or ARFCN as described in the section titled [“FREQUENCY Channel Key Menu” on page 143](#).
- Step 5.** Press the **Burst Type** key to select the desired burst type as described in the section titled [“FREQUENCY Channel Key Menu” on page 143](#).
- Step 6.** If your signal of interest contains more than 1 Training Sequence, press the **TSC** key, and select a standard Training Sequence (numbered 0-9) to which the measurement will synchronize. The default setting for **TSC** is **Auto**, which automatically correlates to any one of the standard Training Sequences numbered 0-9. See [“FREQUENCY Channel Key Menu” on page 143](#).
- Step 7.** Press the **MEASURE, Transmit Pwr** keys to initiate the Transmit Power measurement.

Figure 2-62 Transmit Power Result - Single Burst (with data table)

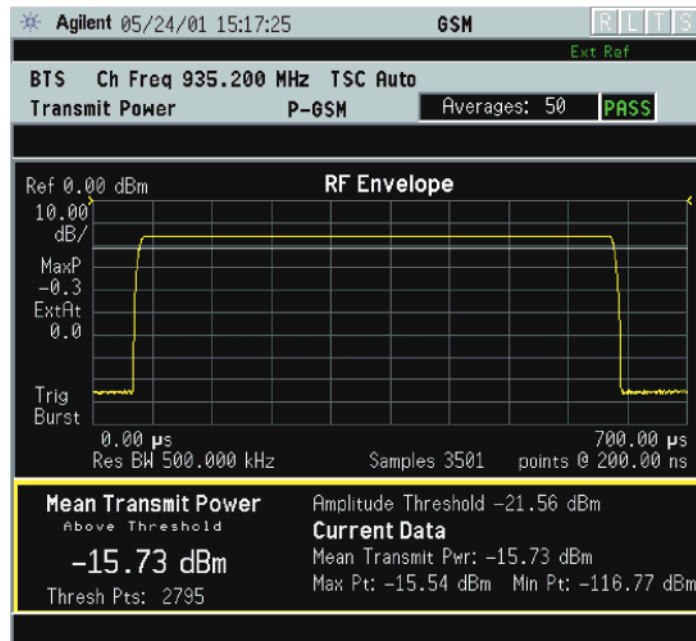

The Transmit Power measurement result display should look like [Figure 2-62](#), with a time domain display of the burst waveform plotted in dB, and the power measurement values displayed below.

Both the averaged and instantaneous results for Mean Transmit Power are displayed on the screen of the instrument. The Averaged Mean Transmit Power Above Threshold is displayed on the left of the display, while the value of the Mean Transmit Power Above Threshold for the current acquisition is displayed on the right of the screen under the heading Current Data Mean Transmit Pwr. If averaging is turned off, the two values can be the same. When you turn averaging on the Mean Transmit Power Above Threshold is an averaged value.

- Step 8.** To capture multiple bursts press the **Meas Setup**, **More (1 of 2)**, and **Meas Time** keys to extend the measurement period (the default setting is 1 slot).

Figure 2-63 Transmit Power Result - Multiple Bursts

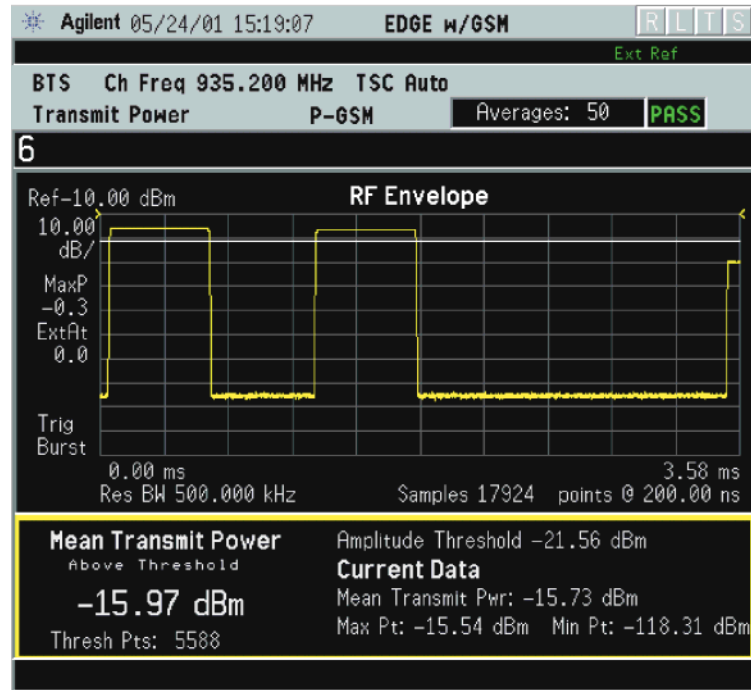

Step 9. Press the **Meas Setup, More (1 of 2)** keys to check the keys available to change the measurement parameters from the default condition.

For more details about changing measurement parameters, see [“Transmit Power Measurement Concepts” on page 526.](#)

If you have a problem, and get an error message, see [“Interpreting Error Codes” on page 137.](#)

Troubleshooting Hints

Low output power can lead to poor coverage and intermittent service for phone users. Out of specification power measurements indicate a fault usually in the power amplifier circuitry. They can also provide early indication of a fault with the power supply, for example the battery in the case of mobile stations.

If you have a problem, and get an error message, see [“Interpreting Error Codes” on page 137.](#)

Waveform (Time Domain) Measurements

This section explains how to make waveform (time domain) measurement on a GSM with EDGE base station. Measurement of I and Q modulated waveforms in the time domain disclose the voltages which comprise the complex modulated waveform of a digital signal.

If installed, you may use PSA Option 122, the 80 MHz Bandwidth Digitizer hardware, or PSA Option 140, the 40 MHz Bandwidth Digitizer hardware to perform Waveform measurements of wideband signals using Basic Mode.

Configuring the Measurement System

The base station (BTS) under test has to be set to transmit the RF power remotely through the system controller. This transmitting signal is connected to the instruments RF input port. Connect the equipment as shown. An interfering or adjacent signal may supplied as shown.

Setting the MS

From the base transmission station simulator (signal generator) and the system controller, set up a call using loopback mode for the MS to transmit the RF signal.

Figure 2-64

Waveform Measurement System

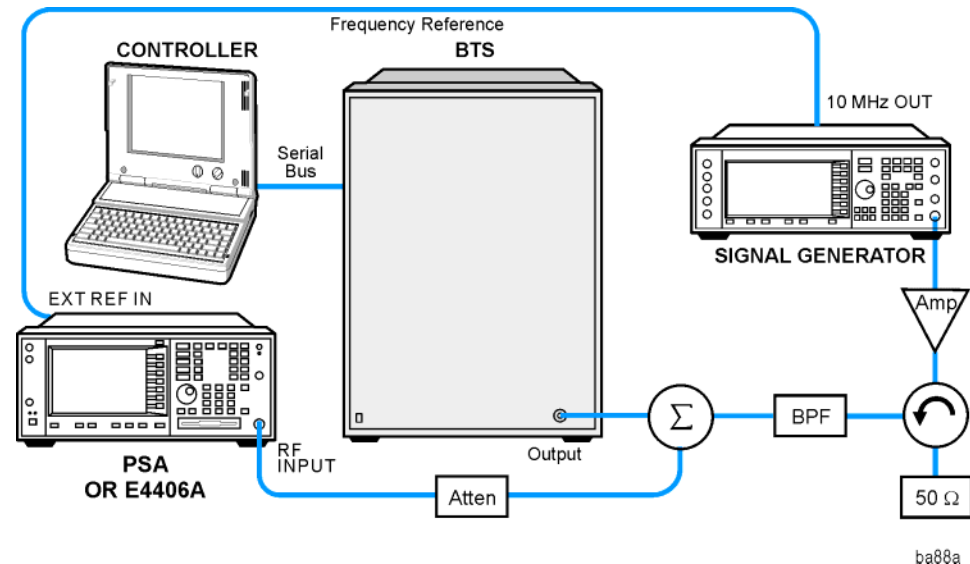

1. Using the appropriate cables, adapters, and circulator, connect the output signal of the BTS to the RF input of the instrument.
2. Connect the base transmission station simulator or signal generator to the BTS through a circulator to initiate a link constructed with sync and pilot channels, if required.
3. Connect a BNC cable between the 10 MHz OUT port of the signal

generator and the EXT REF IN port of the instrument.

4. Connect the system controller to the BTS through the serial bus cable to control the BTS operation.
5. Connect an external trigger, if needed. Press Mode Setup, Trigger to access a menu to set up inputs and levels for all triggers. You must then select the appropriate trigger under the Meas Setup, Trigger menu to direct the measurement to use your trigger settings.

Setting the BTS From the mobile simulator (signal generator) and the system controller, set up a call using loopback mode for the BTS to transmit the RF signal.

Measurement Procedure

- Step 1.** Press the **Preset** key to preset the instrument.
- Step 2.** Press the **MODE**, GSM (w/EDGE) keys to enable the GSM with EDGE Mode measurements.
- Step 3.** To set the measurement center frequency press the **FREQUENCY Channel** key, enter a numerical frequency using the front-panel keypad, and complete the entry by selecting a units key, like **MHz**.
- Step 4.** Press the **SPAN** key, enter a numerical span using the front-panel keypad, and press the **MHz** key to set the measurement span in MHz.
- Step 5.** Press the **MEASURE** key to initiate the Waveform measurement.

The default display shows both **Current** (yellow trace) and **Average** (blue trace) data. To make viewing the display easier, you can view either the **Current** or **Average** trace separately.

- Press **Trace/View, Trace Display**, and select the trace(s) desired for display.

- Step 6.** Press **SPAN X Scale**, and the up or down arrow keys until the waveform is shown at a convenient time scale for viewing.

The next figure shows an example of an **RF Envelope** (key is called **Signal Envelope** on VSA) result for a waveform (time domain) measurement. The measured values for the mean power and peak-to-mean power are shown in the text window.

Figure 2-65 Waveform Measurement - RF Envelope (Default View)

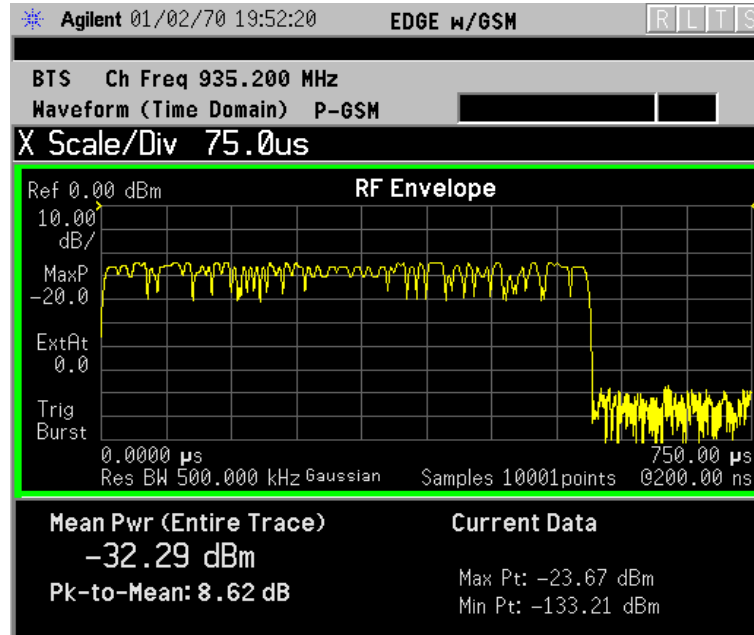

Step 7. Press the **Trace/View** (PSA) or **View/Trace** (E4406A) key to display the menu allowing selection of the other Waveform views, including the following:

- **Linear Envelope** - (for E4406A Option B7C) Provides a combination view of a linear signal envelope graph and a phase graph with linear graticules. Use the **Next Window** and **Zoom** keys to select and enlarge either graph.

Figure 2-66 Waveform Measurement - Linear Envelope View

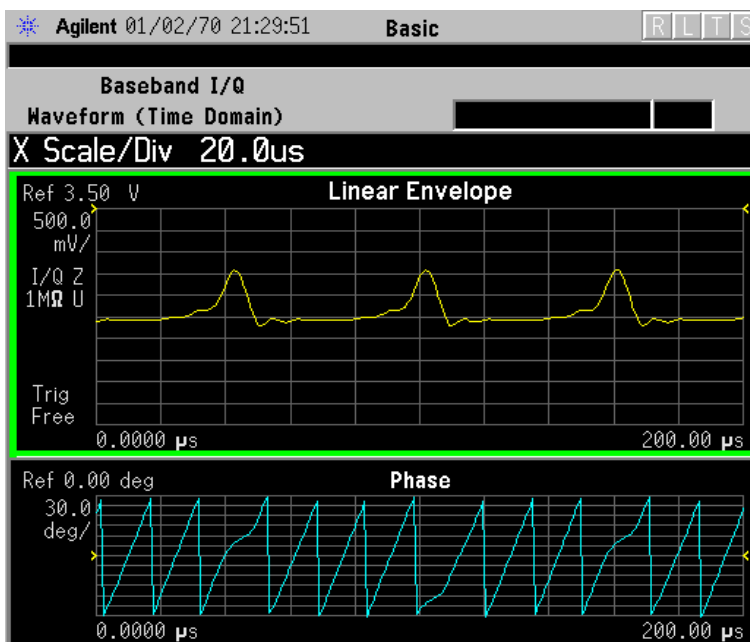

*Meas Setup: View/Trace = Linear Envelope View, GSM signal
 Others = Factory defaults, except X and Y scales

Figure 2-67 Waveform Measurement - Linear Envelope View

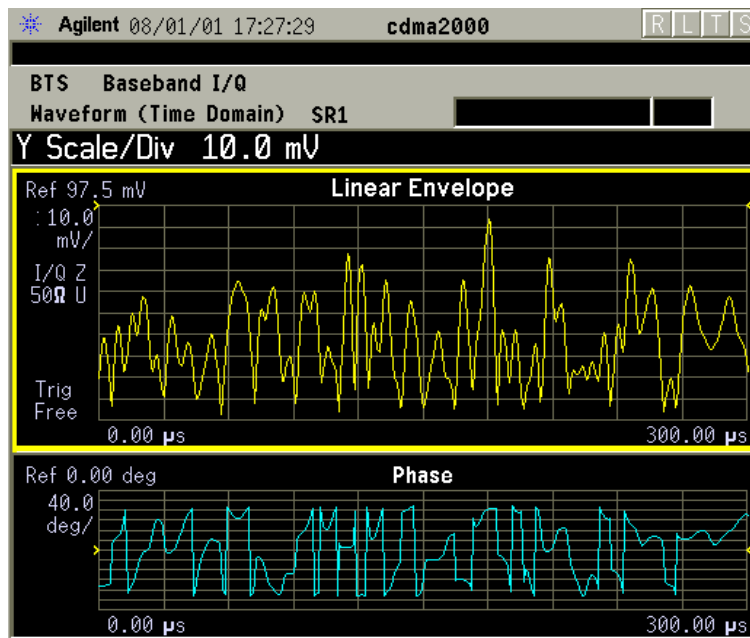

*Meas Setup: View/Trace = Linear Envelope View,
 Others = Factory defaults, except X and Y scales

*Input signal: cdma2000 Rev 8, SR1, 9 Channel

Figure 2-68 Waveform Measurement - Linear Envelope View

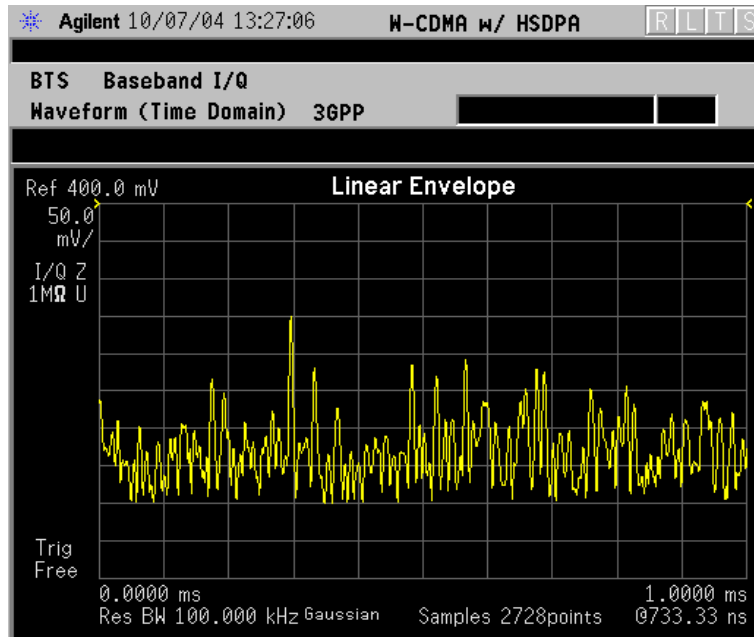

*Meas Setup: View/Trace = Linear Envelope View,
Others = Factory defaults, except X and Y scales

*Input signal: W-CDMA (3GPP 3.4 12-00), 1 DPCH,

Figure 2-69 Waveform Measurement - Linear Envelope View

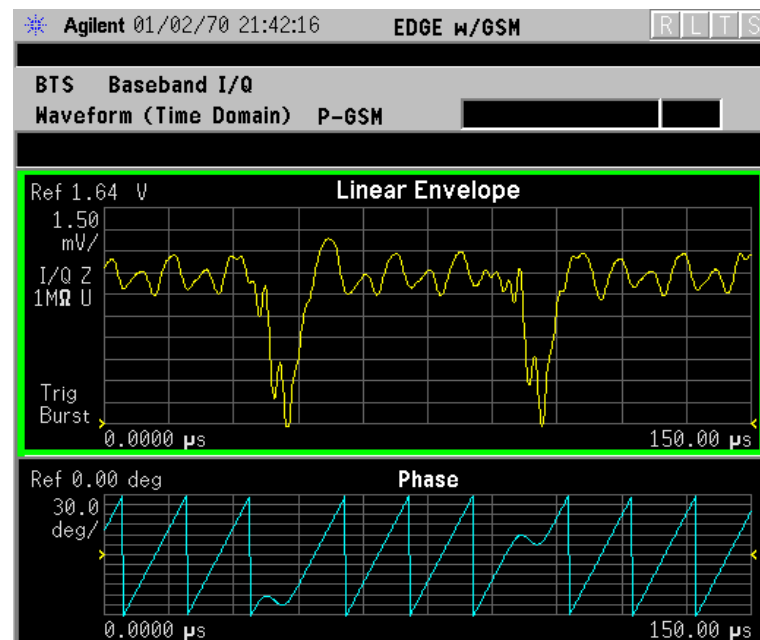

*Meas Setup: View/Trace = Linear Envelope View,
Others = Factory defaults, except X and Y scales

*Input signal: EDGE Standard pattern (4-1's and 4-0's)

- **I/Q Waveform** - Provides a view of the I and Q waveforms together on the same graph in parameters of voltage versus time in linear scale. Changes to the sweep time or resolution bandwidth can affect data acquisition.

Figure 2-70 Waveform Measurement - I/Q Waveform View

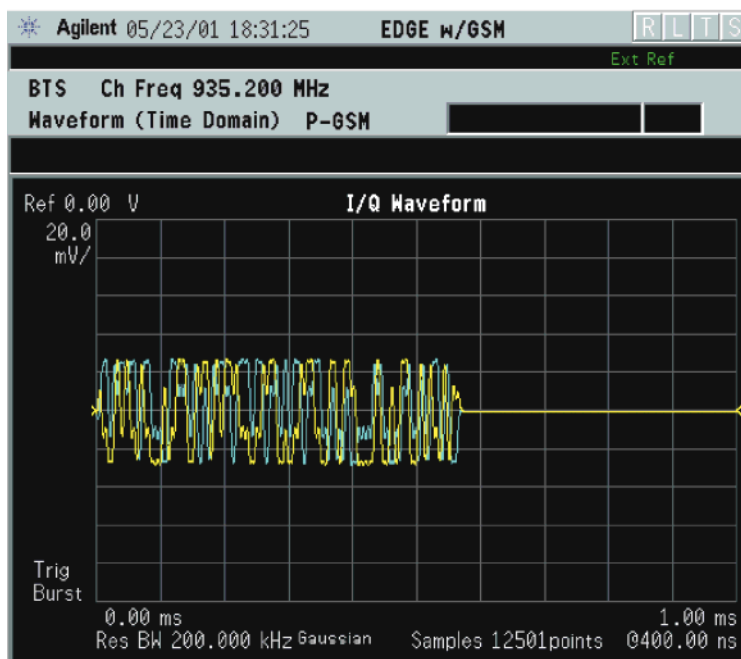

NOTE

For the widest spans the I/Q Waveform window becomes just “ADC time domain samples”, because the I/Q down-conversion is no longer in effect.

- **I and Q Waveform** - (for E4406A Option B7C) Provides a combination view of the I and Q signal waveform graphs in the linear scales.

Figure 2-71 Waveform Measurement - I and Q Waveform View

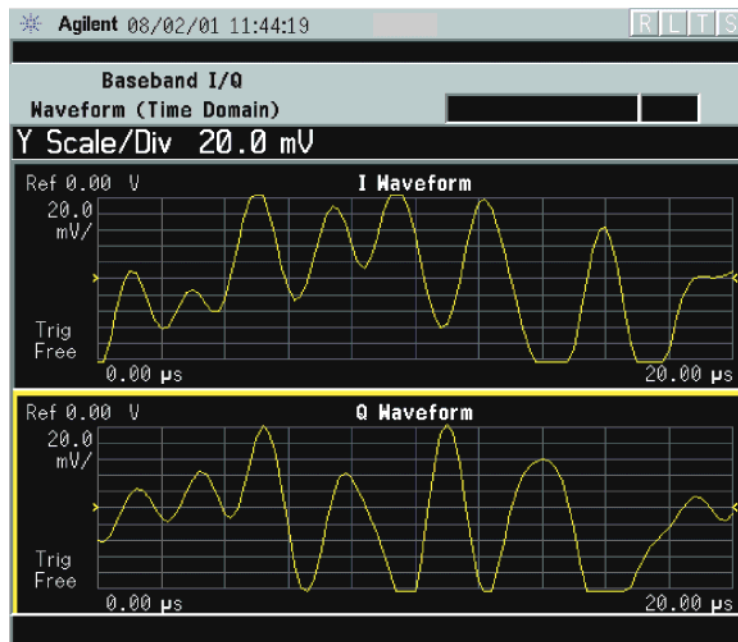

Figure 2-72 Waveform Measurement - I and Q Waveform View

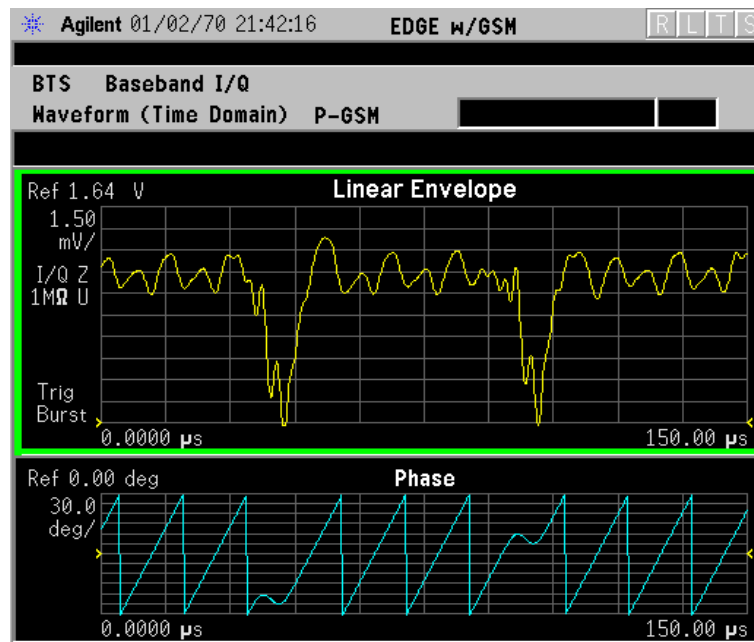
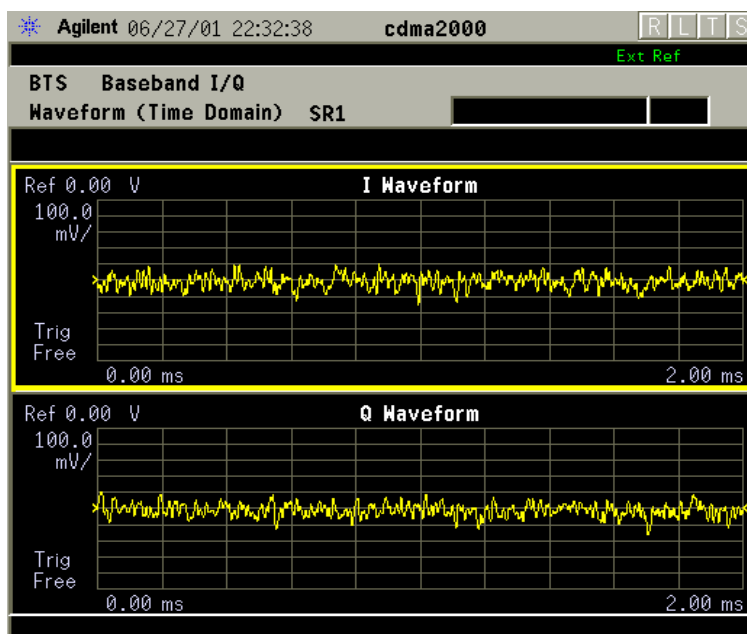

Figure 2-73 Waveform Measurement - I and Q Waveform View



*Meas Setup: View/Trace = I and Q Waveform View,
Others = Factory defaults, except X and Y scales

*Input signal: cdma2000 Rev 8, SR1, 9 Channel

Figure 2-74 Waveform Measurement - I and Q Waveform View

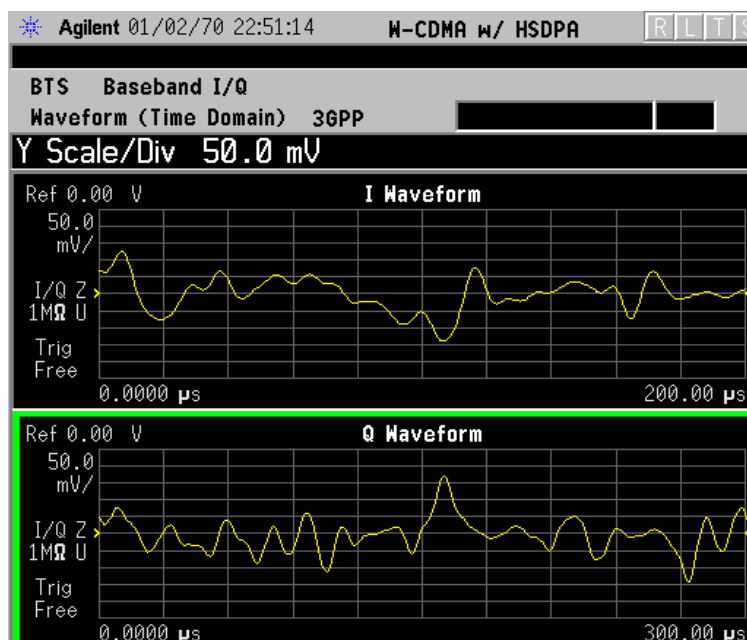

*Meas Setup: View/Trace = I and Q Waveform View,
Others = Factory defaults, except X and Y scales

*Input signal: W-CDMA (3GPP 3.4 12-00), 1 DPCH,

- I/Q Polar - (E4406A) Provides a view of the I/Q signal in a polar vector graph.

Figure 2-75 Waveform Measurement - I/Q Polar View

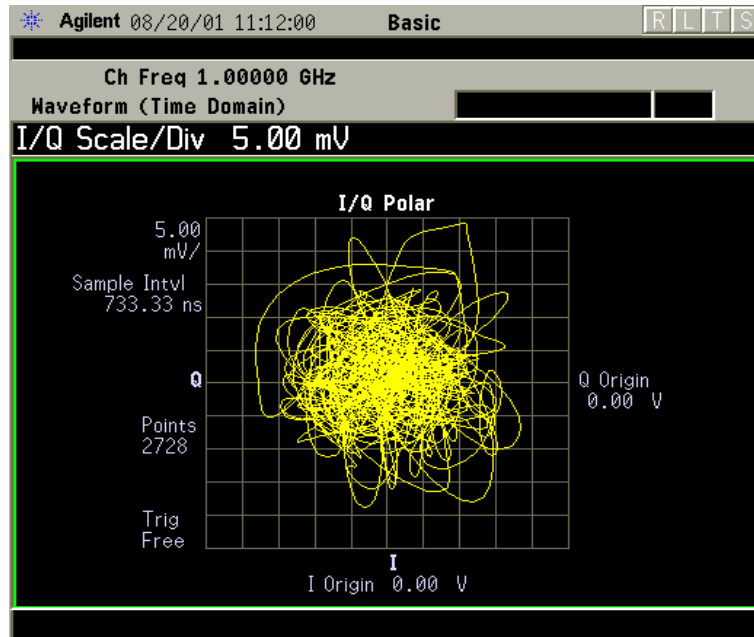

Figure 2-76 Waveform Measurement - I/Q Polar View

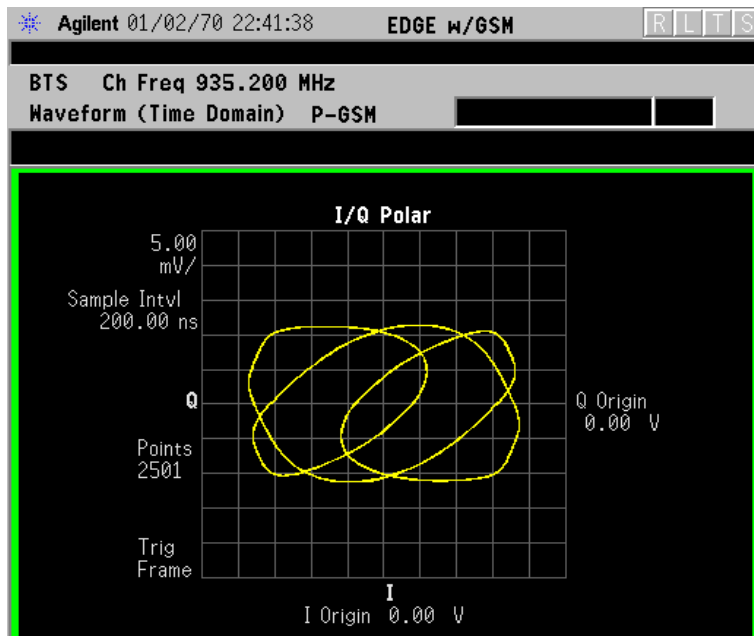
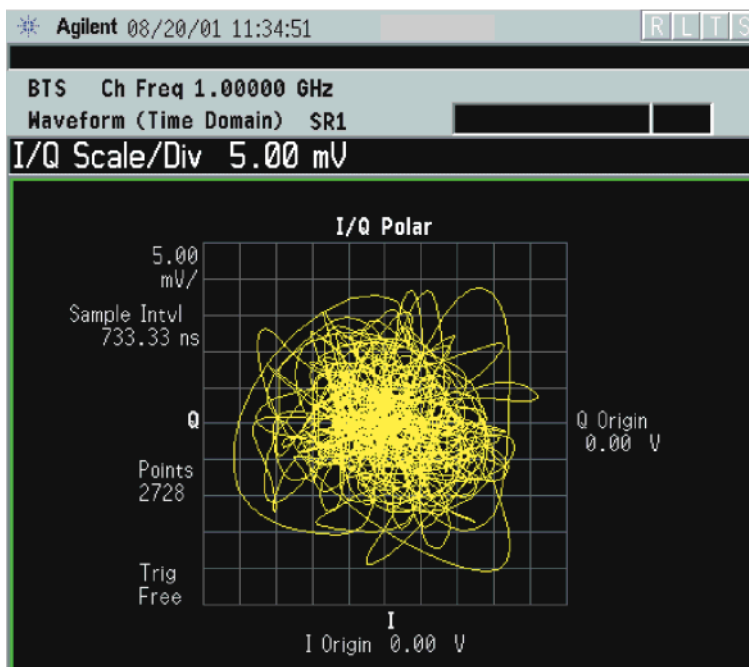

Figure 2-77 Waveform Measurement - I/Q Polar View



*Meas Setup: View/Trace = I/Q Polar View,
Others = Factory defaults, except X and Y scales

*Input signal: cdma2000 Rev 8, SR1, 9 Channel

Figure 2-78 Waveform Measurement - I/Q Polar View

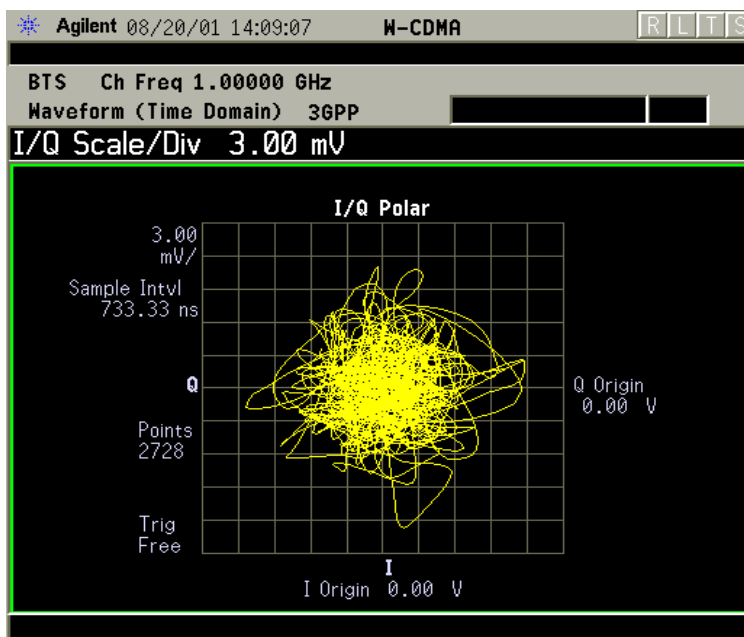

*Meas Setup: View/Trace = I/Q Polar View,
Others = Factory defaults, except X and Y scales

*Input signal: W-CDMA (3GPP 3.4 12-00), 1 DPCH,

Figure 2-79 Waveform Measurement - I/Q Polar View



*Meas Setup: View/Trace = I/Q Polar,
Trigger Source = Ext Rear,
Others = Factory default settings

*Input signal: - 10 dBm, Idle slot, 1xEV-DO

- Step 8.** Press the **AMPLITUDE Y Scale**, and down arrow keys until the waveforms are shown at a convenient voltage scale for viewing.
- Step 9.** Press the **SPAN X Scale**, and down arrow keys until the waveforms are shown at a convenient time scale for viewing.
- Step 10.** Press the **Marker, Trace**, and **I/Q Waveform** keys to activate a marker. Rotate the RPG knob until the marker is shown at a desired time in the waveform for viewing the trace values at the time position of the marker.
- Step 11.** To make a measurement repeatedly, press **Meas Control, Measure** to toggle the setting from **Single** to **Cont**.
- Step 12.** Press the **Meas Setup, More (1 of 2)** keys to check the keys available to change the measurement parameters from the default condition.

Using the Waveform Measurement to Set Up Triggering (for burst signals)

You can use the waveform measurement to view your signal in the time domain and to help select the appropriate trigger to acquire your signal.

- Step 1.** Press **MEASURE, Waveform (Time Domain)** to activate the waveform measurement view.
- Step 2.** Press **SPAN X Scale, Scale/Div**, to adjust the scale of the x-axis to view the complete signal waveform. Use the front-panel keypad to input the scale/div, then press a units key, like μs , to complete the entry.
- Step 3.** Press **Meas Setup, Trig Source**, then select one of the available trigger sources (free run is the default setting).
- Step 4.** Press **Trigger** (or for E4406A press **Mode Setup, Trigger Setup**), then choose a trigger mode to set up the trigger conditions.

In the trigger mode, set the delay, peak level, and positive or negative edge slope trigger. You can also set up trigger holdoff, auto trigger timing, and frame timer settings.

For more details about using PSA Option 122, 80 MHz BW Digitizing Hardware, and PSA Option 140, 40 MHz Digitizing Hardware, including detailed function descriptions, SCPI commands, and concepts, see the PSA Basic Mode Guide.

For more details about changing measurement parameters, see [“Waveform \(Time Domain\) Measurement Concepts” on page 557](#).

Using Option B7C Baseband I/Q Inputs

Baseband I/Q Measurements Available for E4406A VSA Series Transmitter Tester

The following measurements can be made using Baseband I/Q inputs:

- Channel Power
- GSMK Phase and Frequency
- EDGE EVM
- GSM/EDGE Transmit Power
- GSMK P_vT
- EDGE P_vT
- Power Stat CCDF
- Spectrum (Frequency Domain)
- Waveform (Time Domain)

NOTE

The following measurements can not be made using Baseband I/Q Inputs:

- ACP
 - GSMK ORFS
 - GSMK Tx Band Spur
 - EDGE ORFS
 - EDGE Tx Band Spur
-

Baseband I/Q Measurement Overview

Baseband I/Q measurements are similar to RF measurements. To avoid duplication, this section describes only the details unique to using the baseband I/Q inputs. For generic measurement details, refer to the previous “Making Measurements” sections.

To make measurements using baseband I/Q Inputs, make the following selections:

- Select a measurement that supports baseband I/Q inputs. For details see [“Baseband I/Q Measurements Available for E4406A VSA Series Transmitter Tester”](#) on page 131.
- Select the appropriate circuit location and probe(s) for measurements. For details see [“Selecting Input Probes for Baseband](#)

Measurements” on page 559.

- Select baseband I/Q input connectors. For details see Input Port Key Menu in the Key Reference chapter.
- Select just I/Q Setup if desired. For details see IQ Setup Key Menu in the Key Reference chapter.
- Select baseband I/Q input impedance. For details see I/Q Input Z Key Menu in the Key Reference chapter.
- Select a baseband I/Q measurement results view. For details see “Baseband I/Q Measurement Result Examples” on page 132.

Baseband I/Q Measurement Result Examples

The following are examples of new measurement result displays using baseband I/Q Inputs. A notation below each example indicates the nature of the input signal.

Channel Power Measurement

There is a new view for Channel Power measurements with baseband I/Q Inputs: the Channel Power Spectrum view with 0 Hz center frequency.

Figure 2-80 Channel Power - Baseband I/Q Inputs

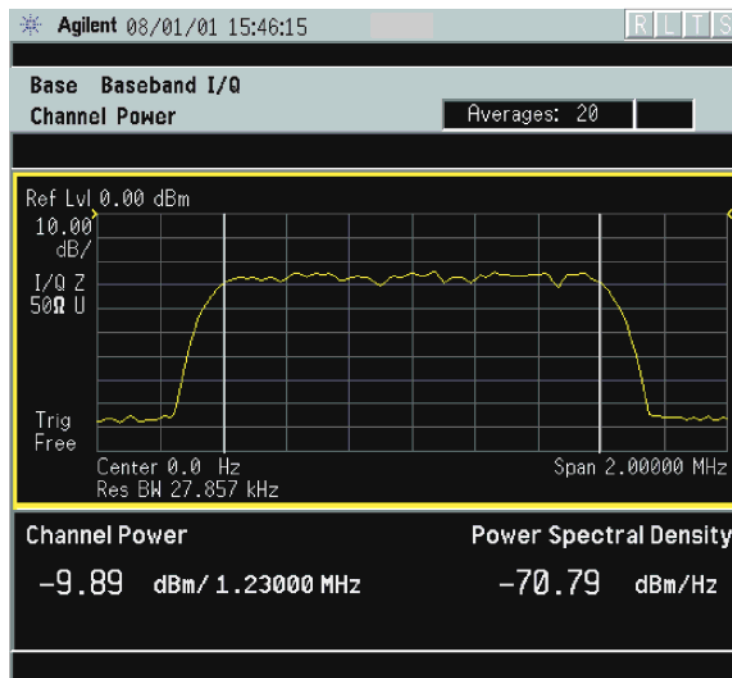

cdma2000 (Rev.8) Downlink, SR1 9 Channel, Baseband I/Q Inputs

Spectrum (Frequency Domain) Measurement

There are two new views with baseband I/Q input Spectrum measurements: the Spectrum view with 0 Hz center frequency, and the Spectrum Linear view with 0 Hz center frequency and the vertical scale in volts.

Figure 2-81

Spectrum View- Baseband I/Q Inputs

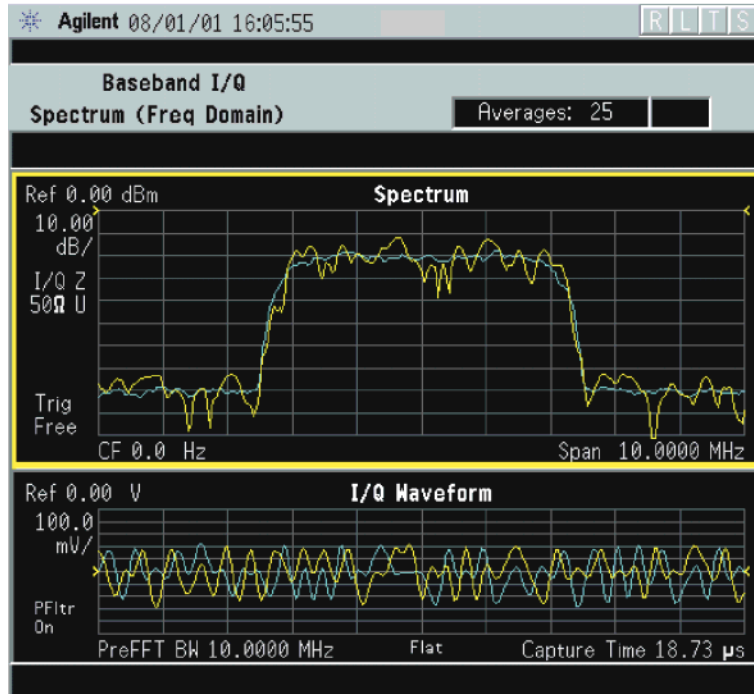

W-CDMA (3GPP 3.4 12-00) Downlink, 1 DCPH, Baseband I/Q Inputs

Figure 2-82 Spectrum Linear View- Baseband I/Q Inputs

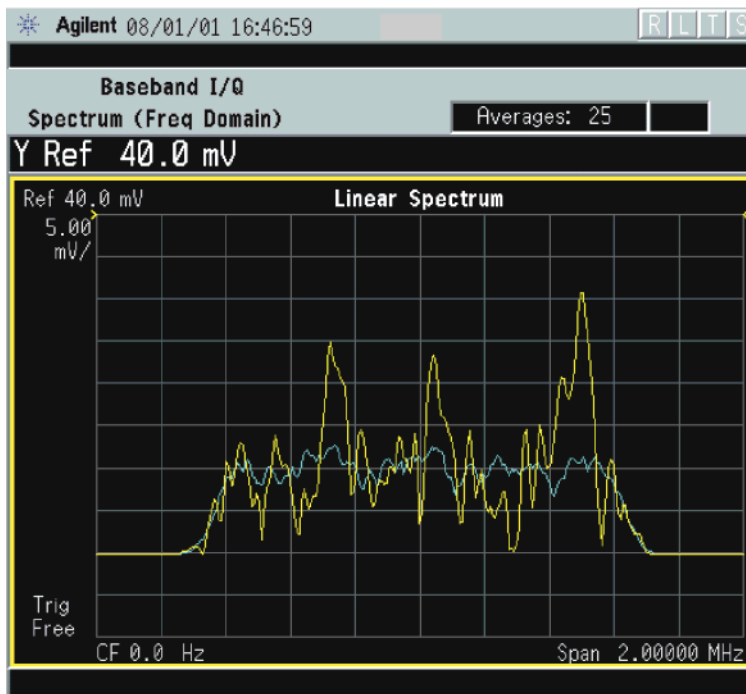

W-CDMA (3GPP 3.4 12-00) Downlink, 1 DCPH, Baseband I/Q Inputs

Waveform (Time Domain) Measurement

There are two new views with baseband I/Q input Waveform (Time Domain) measurements: the Linear Envelope view with the vertical scale in volts, and the I and Q Waveform view with separate windows for the I and Q traces.

Figure 2-83 Waveform Linear Envelope - Baseband I/Q Inputs



Figure 2-84 I and Q Waveform View - Baseband I/Q Inputs

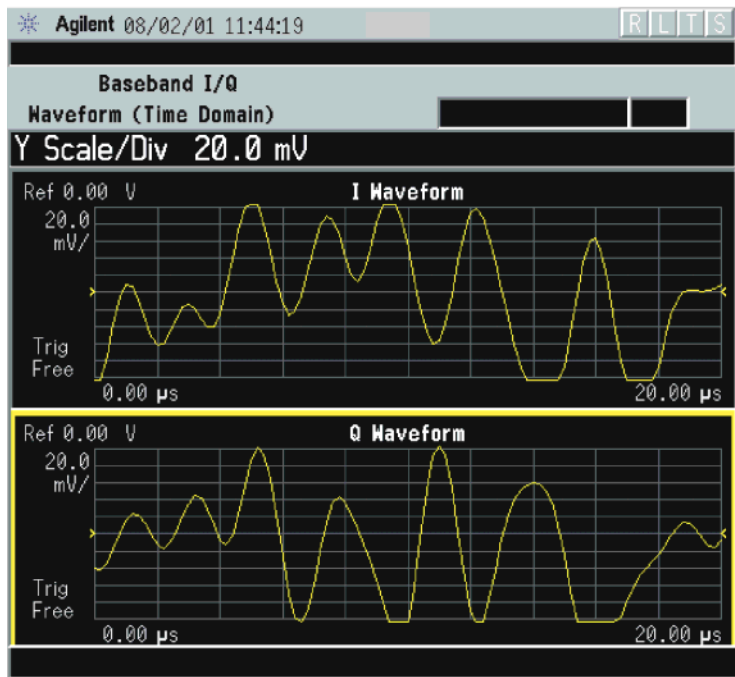

Making Measurements

Using Basic Mode

Basic mode is a standard feature of E4406A Transmitter Testers, and is part of Option B7J for the PSA Series Spectrum Analyzers. Basic mode is *not* related to a particular communications standard. That is, it does not default to measurement settings that are for any specific standard. You may want to use Basic Mode if you are making measurements on a signal that is not based on a specific digital communications standard.

Basic Mode in E4406A VSA Series Transmitter Testers

There are five generic measurements available under the **MEASURE** key in Basic mode:

- Adjacent Channel Power (ACP)
- Channel Power
- Power Statistics CCDF
- Spectrum measurement (frequency domain).
- Waveform measurement (time domain)

The ACP, Channel Power, and Power Stat CCDF measurements are fully described in the VSA Series User's Guide. Please refer to that manual for complete information on these measurements.

Spectrum and Waveform Measurements

These measurements provide a spectrum measurement mode that is similar to a standard spectrum analyzer, and a waveform measurement mode that is similar to a microwave oscilloscope. Unlike those standard analyzers, these measurements are optimized for digitally modulated signals, so they can be used to output the measured I/Q data.

For your convenience, Spectrum and Waveform measurements are also available in this mode, with the same functionality, so you can refer to the sections included in this chapter for information about using them.

Basic Mode in PSA Series Spectrum Analyzers

There are two generic measurements available under the **MEASURE** key in Basic mode:

- Spectrum measurement (frequency domain).
- Waveform measurement (time domain)

These Spectrum and Waveform measurements are also available in this mode, with the same functionality, so you can refer to the sections included in this chapter for information about using them.

Interpreting Error Codes

During the execution of your measurement you may encounter problems which generate error codes. Referring to the following common errors may be helpful.

If **Err** is shown in the annunciator bar, press the **System, Show Errors** hard and soft keys to read the detailed error information.

- **Measurement Instability- Low Input Signal Level**

If the input signal level is too low to make a valid measurement, no code domain power is displayed in the **Power** graph window. In this situation, no error message can be displayed to indicate the nature of the fault. If you cannot increase the power into the tester, you need to increase the input sensitivity by adjusting the ADC range.

Press **Meas Setup, More (1 of 3), More (2 of 3), Advanced, ADC Range**, and then **Manual** keys. Increase the setting from the -6 dB (for E4406A) or None (for PSA) default to 6 dB, for example. Another option is to use the **Auto** setting (the **Auto** setting is not used as the default to improve measurement speed).

Press **Restart** to make another measurement and observe the results. Re-adjust the ADC as necessary to obtain a valid measurement.

- **Error Code 16 “Input overload”**

This error means that your measurement has erroneous results due to the excessive input power level. To correct this condition, the input signal level must be reduced by using the internal and/or external attenuators.

Press the **Mode Setup, Input, Input Atten** keys to enter an attenuation value to reduce the transmitted power from the MS. This allowable range is up to 40 dB.

If you want to attenuate more than 40 dB, connect your external attenuator between the **RF INPUT** port and the DUT. Be sure to add its attenuation value to the readings of the measurement result.

To automate this calculation, press the **Mode Setup, Input, Ext Atten** keys to enter the additional attenuation value. The allowable range is up to 100 dB. The power readings of the measurement take into account the external attenuation value.

- **Error Code 601 “Signal too noisy”**

This error means that your input signal is too noisy to capture the correct I/Q components. To make a more stable measurement the trigger source may need to be set to **Frame**, for example.

- **Error Code 604 “Can not correlate to input signal”**

This error means that the tester has failed to find any active channels in the input signal as specified. To improve the correlation some critical parameters need to be adjusted, for example, the input signal level or scramble code.

For more details consult the chapter in this book dedicated to the measurement in question, or see the “Instrument Messages and Functional Tests” manual.

3 Key Reference

This chapter provides detailed descriptions of the keys used to set up and make GSM and EDGE measurements, including **Mode Setup**, **Meas Setup**, and **MEASURE**. Keys that allow you to see different presentations of the measurement results are also described, including **Trace/View**, and **Display**, showing the associated screens.

Instrument Front Panel Highlights

The most commonly used function keys on the VSA and PSA front panels are located as shown in the illustrations below. The operation of the keys is briefly explained on the following page. Refer to your User's Guide for complete details on all keys.

Figure 3-1 Selected E4406A VSA Series Front Panel Feature Locations

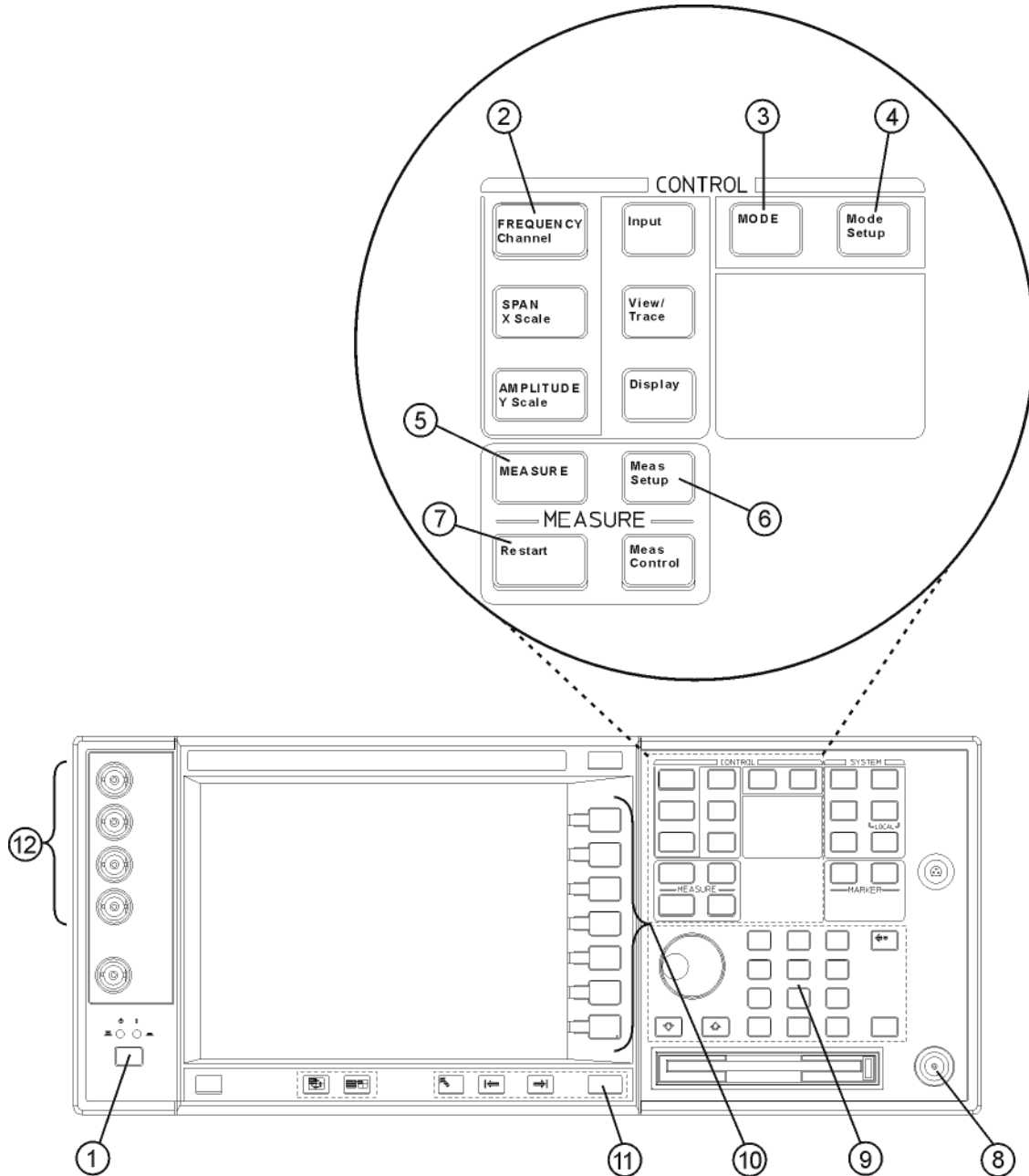

aa81a

Figure 3-2 Selected PSA Series Front Panel Feature Locations

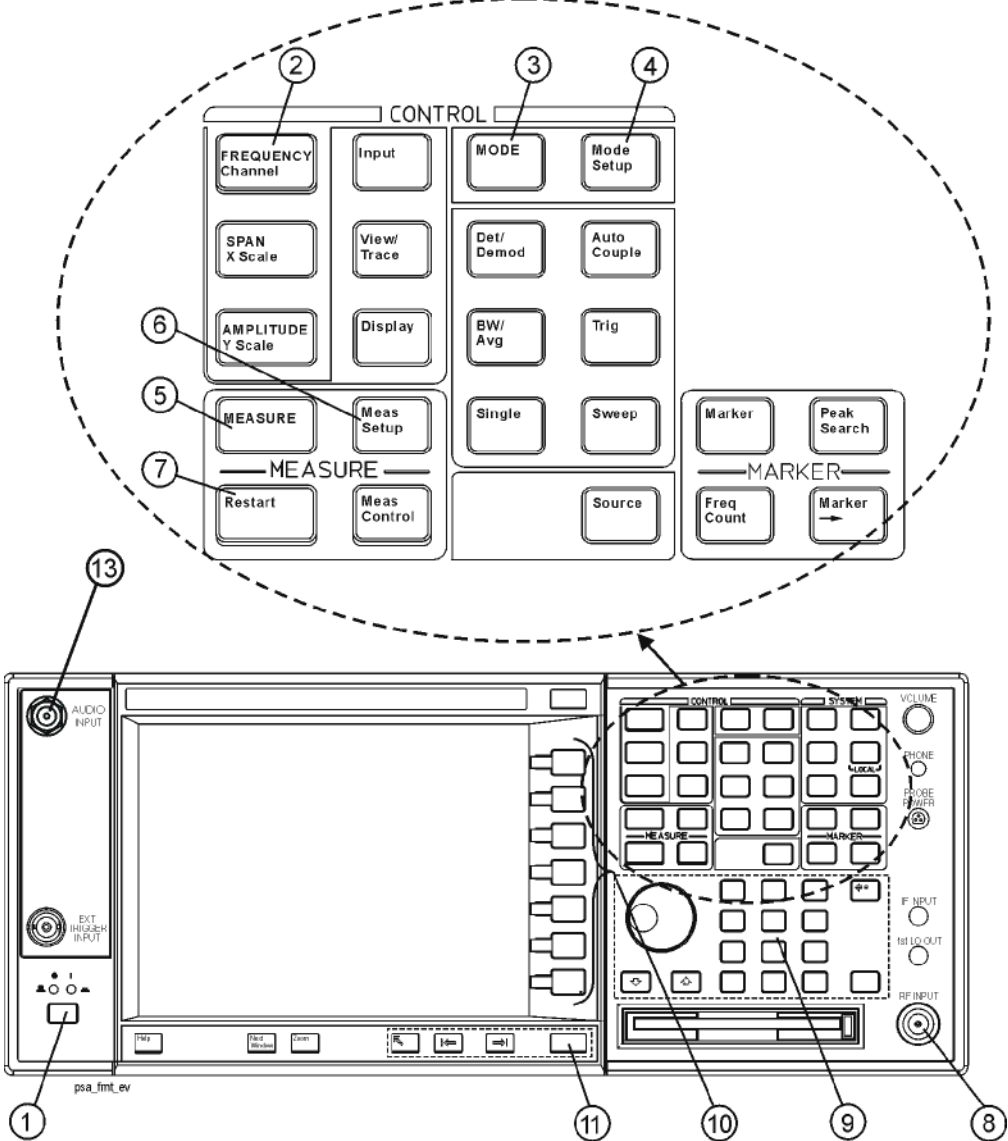

Selected E4406A VSA and PSA Front-Panel Features

- 1. The **On/Off** switch toggles the AC Line power between On and Standby. A green LED will light when the instrument is On. When energized in the standby mode, a yellow LED is lit above the switch.
- 2. **FREQUENCY Channel** accesses a key menu to set the analyzer center frequency in units of Hz, kHz, MHz, or GHz, or by channel number. These parameters apply to all measurements in the current mode.
- 3. **MODE** accesses a key menu to select one of the measurement

personalities installed in the instrument. Each mode is independent from all other modes.

4. **Mode Setup** accesses a key menu that sets parameters specific to the current mode and can affect all measurements within that mode.
5. **MEASURE** accesses a display key menu to initiate one of the various measurements that are specific to the current mode.
6. **Meas Setup** accesses the menus of test parameters that are specific to the current measurement.
7. **Restart** causes a measurement to start again from the initial process according to the current measurement setup parameters.
8. **RF INPUT** port: Type N connector for the E4406A VSA and E4443A, E4445A, and E4440A PSAs. It is a 2.4 mm connector on the E4446A and E4448A PSAs and a 3.5 mm connector on all PSAs with Opt BAB. The maximum input power level is shown next to the port.
9. The **Data Entry** keypad is used to enter numeric values. Keypad entries are displayed in the active function area of the screen and become valid for the current measurement upon pressing the **Enter** key or selecting a unit of measurement, depending on the parameter.
10. The Display Menu keys allow you either to activate a feature or to access a more detailed sub-menu. An arrow on the right side of a softkey label indicates that the key has a further selection menu. The active menu key is highlighted, however, grayed-out keys are currently unavailable for use or only show information. If a menu has multiple pages, successive pages are accessed by pressing the **More** key located at the bottom of the menu.
11. **Return** allows you to exit the current menu and display the previous menu. If you are on the first page of a multi-page menu (a menu with **(1 of 3)** for example), the **Return** key will exit from that menu. When you activate another measurement, the return list is cleared. The **Return** key will not return you to a previously activated mode, nor will it alter any values you have entered in previous menus.
12. **Baseband I/Q Inputs** (E4406A Option B7C only) allow you to analyze signals at baseband frequencies. See [“Using Option B7C Baseband I/Q Inputs” on page 1](#).
13. **BNC Audio Input** (PSA Option 233 Measuring Receiver only) provides a 100 kOhm input for audio measurements. The frequency range is 20 Hz to 250 kHz. The safe input level is 7 Vrms or 20 V DC.

Front Panel Keys

NOTE Only front panel keys affected by the selection of GSM or GSM and EDGE mode are described here. For a complete description of all front panel keys see the E4406A VSA or PSA Series User's Guide.

FREQUENCY Channel Key Menu

Key Path: **FREQUENCY Channel**

NOTE After selecting the desired mode setup, you need to select the desired ARFCN, center frequency, BMT frequency, burst type, and TSC (Training Sequence Code). The selections made here apply to all measurements in the mode.

Frequency Channel menu:

- **ARFCN**

Allows you to select the desired RF channel to be measured. Refer to the table below for the ARFCN range for a specific GSM band.

- **Center Freq**

This is the current instrument center frequency. Use this key to input a frequency that corresponds to the desired RF channel to be measured.

- **BMT Freq**

Allows you to select the Bottom, Middle, or Top frequencies of the GSM selected radio band to be measured. This automatically selects a specific center frequency and ARFCN. Refer to the following table.

| Band | Tx Band Edge (MHz) | | BOTTOM | | MIDDLE | | TOP | |
|----------|--------------------|------|------------|-------|------------|-------|------------|-------|
| | Low | High | Freq (MHz) | ARFCN | Freq (MHz) | ARFCN | Freq (MHz) | ARFCN |
| P-GSM | 935 | 960 | 935.200 | 1 | 947.600 | 63 | 959.800 | 124 |
| E-GSM | 925 | 960 | 925.200 | 975 | 942.600 | 38 | 959.800 | 124 |
| R-GSM | 921 | 960 | 921.200 | 955 | 940.600 | 28 | 959.800 | 124 |
| DCS 1800 | 1805 | 1880 | 1805.20 | 512 | 1842.60 | 699 | 1879.80 | 885 |

| Band | Tx Band Edge (MHz) | | BOTTOM | | MIDDLE | | TOP | |
|----------|--------------------|-------|------------|-------|------------|-------|------------|-------|
| | Low | High | Freq (MHz) | ARFCN | Freq (MHz) | ARFCN | Freq (MHz) | ARFCN |
| PCS 1900 | 1930 | 1990 | 1930.20 | 512 | 1960.00 | 661 | 1989.80 | 810 |
| GSM 450 | 460.4 | 467.6 | 460.600 | 259 | 464.000 | 276 | 467.400 | 293 |
| GSM 480 | 488.8 | 496.0 | 489.000 | 306 | 492.400 | 323 | 495.800 | 340 |
| GSM 700 | 747 | 762 | 747.2 | 438 | 754.6 | 475 | 761.8 | 511 |
| GSM 850 | 869 | 894 | 869.200 | 128 | 881.600 | 190 | 893.800 | 251 |

- **Timeslot**

Selects which one of the 8 time slots in a frame is active (timeslot 0 is the default, both when set to On and when set to Off). Timeslot is available when **Burst Sync** is either **Training Sequence** or **RF Amptd**; otherwise it is unavailable (greyed out).

The timeslots are determined by taking the acquired data and dividing it into timeslots 0 to 7. An active timeslot burst must be within approximately 25% of the expected timeslot position, otherwise the instrument may think the burst is an adjacent timeslot and may not detect it. The trigger delay can be used to position the signal if it is not aligned in the timeslots as desired.

- **Burst Type**

Choose an EDGE or GSM burst type from the following selections:

Normal (TCH & CCH) - Burst length = 142 symbols

This is the default setting for EDGE (with GSM), and should be used for all EDGE burst measurements.

Sync (SCH) - Burst length = 142 symbols

Use of this Burst Type is usually associated with GSM measurements.

Access (RACH) - Burst length = 88 symbols

Use of this Burst Type is usually associated with GSM measurements.

- **TSC**

Allows you to select the Training Sequence Code that determines which burst is to be measured. This key is unavailable (grayed out) if a burst type other than **Normal** is selected, indicating the standard TSC is used corresponding to the burst type. **Burst Sync** must be set to **Training Sequence**.

Auto -The measurement is made on the first burst found to have any one of the valid TSCs in the range of 0 to 7. The measurement may be made on various timeslots if more than one timeslot has one of the 8 valid TSCs.

Man - The measurement is made on the first burst found to have the selected TSC. TSC numbers in the range of 0 to 7 can be selected. The measurement may be made on various timeslots if more than one timeslot has this same TSC.

Frequency Channel Defaults

When the EDGE (with GSM) or GSM w/EDGE mode is selected, the instrument defaults to the following settings.

| Function | Factory Default Setting |
|------------------|-------------------------|
| ARFCN | 1 |
| Center Frequency | 935.200 MHz |
| Timeslot | 0 Off |
| Burst Type | Normal (TCH & CCH) |
| TSC (Std) | 0 Auto |

Measurement Control Key Menu

Key Path: **Meas Control**

Meas Control Key menu:

- **Measure** - Toggles between Single and Cont (for continuous) measurement states (This is not the same as the front panel **MEASURE** key which is used to select measurements). When set to Single, the measurement continues until it has reached the specified number of averages set by the average counter. When set to Continuous, the measurement runs continuously, and performs averaging according to the current average type (repeat or exponential). The default setting is continuous.
- **Pause** - Pauses the current measurement. Once toggled, the label of the **Pause** key changes to read **Resume**. The **Resume** key, once pressed, continues the active measurement from the point at which it was paused.
- **Restart** - Repeats the current measurement from the beginning, while retaining the current measurement settings.

MODE Key Menu

Key Path: **MODE**

For PSA:

To access the measurement personality that includes EDGE and GSM, press the **MODE** key and select the **GSM w/EDGE** key.

For E4406A:

To access the GSM measurement personality, press the **MODE** key and select the **GSM** key.

To access the measurement personality that includes EDGE and GSM, press the **MODE** key and select the **EDGE w/GSM** key.

NOTE

Mode settings are persistent. When you switch from one mode to another mode, the settings you have chosen for the modes remain active until you change them. This allows you to switch back and forth between modes without having to reset settings each time. Presetting the instrument or powering the instrument off and on returns all mode settings to their default values.

Mode Setup Key Menu

Key Path: **Mode Setup**

- **Radio** key menu:

Band - Selects the GSM band (P-GSM, E-GSM, R-GSM, GSM 450, GSM 480, GSM 700, GSM 850, DCS 1800, or PCS 1900). Refer to the table in the previous section for GSM band data.

Device - Selects the device to test BTS (Base Transceiver Station) or MS (Mobile Station).

BTS Type - Selects the type of BTS (Base Transceiver Station) to be tested (Normal, Micro1, Micro2, Micro3, or Pico).

Freq Hopping - Turns frequency hopping on or off. If frequency hopping is turned on, the instrument ignores the bursts when the frequency is hopped off the selected channel frequency. Thus only valid data is included in the results. Only the Power vs. Time, EDGE EVM, and Phase and Frequency Error measurements can be made on hopping GSM signals.

Carrier - Selects the type of carrier to measure (Burst or Continuous). Most standards based measurements use a burst carrier. A continuous carrier may be used for measurement of GSM Phase and Frequency Error, and may be suitable for other non-standards based measurement needs. See the section [“GMSK Phase and Frequency Error Measurement Concepts” on page 533](#).

| Radio Default Settings | |
|------------------------|--------|
| Band | P-GSM |
| Device | BTS |
| BTS Type | Normal |
| Freq Hopping | Off |
| Carrier | Burst |

Key Reference
Front Panel Keys

- **Input** key menu:
Key Path: **Mode Setup, Input**

NOTE You can also access the **Input** key menu from the **Input/Output** front-panel key. For details of **Input/Output** key see [“Input/Output Key Menu” on page 152.](#)

- **Trigger** key menu:

NOTE These menus are used to set Trigger parameters only. The actual trigger source is selected separately for each measurement under the **Meas Setup** key.

RF Burst

Delay - For trigger delay use positive values. For pre-trigger use negative values.

Level - For the **RF Burst** selection, the level is relative to the peak level of the RF signal. For the **Video** selection, the level is the value, in dBm at the RF input, that will cause the trigger. For the **Ext Front** and **Ext Rear** selections, the level range is -5 to +5 volts.

Slope Pos Neg - Choose to trigger off of the leading edge (**Pos**) or the trailing edge (**Neg**) of the burst.

Video (Envlp)

Delay - For trigger delay use positive values. For pre-trigger use negative values.

Level - For the **RF Burst** selection, the level is relative to the peak level of the RF signal. For the **Video** selection, the level is the value, in dBm at the RF input, that will cause the trigger. For the **Ext Front** and **Ext Rear** selections, the level range is -5 to +5 volts.

Slope Pos Neg - Choose to trigger off of the leading edge (**Pos**) or the trailing edge (**Neg**) of the burst.

Ext Front

Delay - For trigger delay use positive values. For pre-trigger use negative values.

Level - For the **RF Burst** selection, the level is relative to the peak level of the RF signal. For the **Video** selection, the level is the value, in dBm at the RF input, that will cause the trigger. For the **Ext Front** and **Ext Rear** selections, the level range is -5 to +5 volts.

Slope Pos Neg - Choose to trigger off of the leading edge (**Pos**) or the trailing edge (**Neg**) of the burst.

Ext Rear

Delay - For trigger delay use positive values. For pre-trigger use negative values.

Level - For the **RF Burst** selection, the level is relative to the peak level of the RF signal. For the **Video** selection, the level is the value, in dBm at the RF input, that will cause the trigger. For the **Ext Front** and **Ext Rear** selections, the level range is -5 to +5 volts.

Slope Pos Neg - Choose to trigger off of the leading edge (**Pos**) or the trailing edge (**Neg**) of the burst.

Trig Holdoff - Sets the period of time before the next trigger can occur.

Auto Trig - Acts as a trigger time-out. If no trigger occurs by the specified time, a trigger is automatically generated.

Frame Timer - Accesses the menu to manually control the frame timer:

Period - Sets the period of the frame clock. The default is 4.615385 μ s (1 GSM frame).

Offset - Sets a one-time phase adjustment of the frame clock.

Reset Offset - Resets the display of offset key to 0.

Sync Source - Selects the source used to sync the frame timer (Ext Front, Ext Rear, or Off).

RF Sync Delay - In measurements that detect the GSM “T0”, **RF Sync Delay** adjusts the “T0” point. This adjustment does not apply if the **Burst Sync** key is set to **None**, or if it is set to **Training Seq** in the Phase and Frequency Error measurement. The “T0” point is defined as the time point of the transition from bit 13 to bit 14 of the midamble training sequence for a given time slot.

Burst Search Threshold - Sets the threshold level used in the search for EDGE or GSM bursts after data is acquired. This is a relative level based on the peak “on” power.

| Trigger Default Settings | |
|---------------------------------|-----------|
| RF Burst | |
| Delay | 0.000 s |
| Peak Level | -25.00 dB |
| Slope | Pos |

Key Reference
Front Panel Keys

| Trigger Default Settings | |
|---------------------------------|--------------|
| Video | |
| Delay | 0.000 s |
| Level | -6.00 dBm |
| Slope | Pos |
| Ext Front | |
| Delay | 0.000 s |
| Level | 2.00 V |
| Slope | Pos |
| Ext Rear | |
| Delay | 0.000 s |
| Level | 2.00 V |
| Slope | Pos |
| Trig Holdoff | 0.000 s |
| Auto Trig | 100.0 ms Off |
| Frame Timer | |
| Period | 4.615383 ms |
| Offset | 0.000 s |
| Reset Offset | Display |
| Sync Source | Off |
| RF Sync Delay | 0.000 s |
| Burst Search Threshold | -30.00 dB |

- **Demod Menu**

Burst Align - Select the burst alignment between:

GSM - Uses the burst alignment as defined in the GSM specifications.

1/2 Bit Offset - Shifts the burst alignment by 1/2 bit. This selection applies to the Power vs. Time and the Phase and Frequency Error measurements.

RF Carrier - When carriers other than the signal of interest are present, especially if they are stronger, they can interfere with the measurement, making it difficult to sync and producing artificially high EVM results. When this condition exists, toggle **RF Carrier** from **Single** to select **Multi**. A band-limited filter 600KHz wide will help reduce the measurement interference. This selection is only available for EDGE EVM and GSM Phase and Frequency measurements.

| Demod Default Settings | |
|-------------------------------|--------|
| Demod Burst Align | GSM |
| RF Carrier | Single |

Input/Output Key Menu

Key Path: **Input/Output**

Input key menu:

NOTE

You can also access the **Input** key menu from the **Mode Setup** front-panel key.

- **Input Port** - Allows you to access the menu to select one of the signal input ports as follows (including Baseband IQ Inputs, Option B7C, when installed in E4406A):

RF - Allows you to measure an RF signal supplied to the RF input port.

I/Q - (For E4406A, Requires E4406A Option B7C. See [“Using Option B7C Baseband I/Q Inputs” on page 131.](#)) Allows you to measure the I/Q input signals supplied to the **I** and **Q INPUT** ports.

I only - (Requires E4406A Option B7C. See [“Using Option B7C Baseband I/Q Inputs” on page 131.](#)) Allows you to measure the I input signal supplied to the **I INPUT** port.

Q only - (Requires E4406A Option B7C. See [“Using Option B7C Baseband I/Q Inputs” on page 131.](#)) Allows you to measure the I input signal supplied to the **Q INPUT** port.

50 MHz Ref - (For E4406A) Allows you to measure the **50 MHz Reference** signal to calibrate the instrument.

Amptd Ref (f=50 MHz) - (For PSA) Allows you to measure the 50 MHz reference signal to calibrate the instrument.

IF Align - Allows you to configure the IF alignment signal. The RF path is switched to bring in the same alignment signal that is automatically switched to perform many alignments.

Baseband Align Signal - (For E4406A) Selects an internal signal used for alignment of Option B7C baseband inputs.

- **I/Q Setup** - (For E4406A) Allows you to access the menu to select the input impedance for the baseband I/Q input signals, and to set the dc offset voltages for I/Q input signals. This key is grayed out unless **Input Port** is set to either **I/Q**, **I only**, or **Q only**.

I Offset - Allows you to set a dc offset voltage value for the I input signal. The range is 0.0000 to 2.5600 V in 0.0001 V.

Q Offset - Allows you to set a dc offset voltage value for the Q input signal. The range is 0.0000 to 2.5600 V in 0.0001 V.

I/Q Input Z - Allows you to access the menu to select one of the input impedances for baseband I/Q input signals as follows:

50 Ω Unbalanced - Allows you to set the input impedance to unbalanced 50 Ω for use with the I/Q input ports. This is the default setting.

600 Ω Balanced - Allows you to set the input impedance to balanced 600 Ω for use with the I/Q input ports and the I/Q input ports.

1 M Ω Unbalanced - Allows you to set the input impedance to 1 M Ω for use with the I/Q input ports.

1 M Ω Balanced - Allows you to set the input impedance to 1 M Ω for use with the I/Q input ports and the I/Q input ports.

I/Q Z Ref - Allows you to enter a numeric value to set the reference impedance if **I/Q Input Z** is set to 1 M Ω , otherwise this key is grayed out. The range is x.x to y.y MW in z.z MW.

- **RF Input Range** - Allows you to toggle the RF input range control between **Auto** and **Man** (manual). If **Auto** is chosen, the instrument automatically sets the attenuator based on the carrier power level, where it is tuned. Once you change the **Max Total Pwr** or **RF Input Atten** value with the RPG knob, for example, the **RF Input Range** key is automatically set to **Man**. If there are multiple carriers present, the total power might overdrive the front end. In this case you need to set the **RF Input Range** to **Man** and enter the expected maximum total power by activating the **Max Total Pwr** key. **Man** is also useful to hold the input attenuation constant for the best relative power accuracy. For single carriers it is generally recommended to set this to **Auto**.

CAUTION

If you manually change the RF Input range setting from **Auto** to **Man**, you may not have optimized the dynamic range for the current measurement, and you may not get the most accurate results. As a reminder, on selected measurements a message is displayed as follows: “Dynamic Range Not Optimum - set AUTO RF Input”. This message is not displayed unless there is a measurement pending.

For PSA, when you use the internal preamplifier, Int Preamp, the selections using the **RF Input Range** key are not available, and the key is greyed-out.

For E4406A, if **Input Port** is set to **I/Q** this key is grayed out

- **Max Total Pwr** - Allows you to set the maximum total power level from the UUT (Unit Under Test). The range is -200.00 to 100.00 dBm with 0.01 dB resolution. This is the expected maximum value of the mean carrier power referenced to the output of the UUT; it may include multiple carriers. The **Max Total Pwr** setting is coupled together with the **Input Atten** and **Ext Atten** settings. Once you change the **Max Total Pwr** value with the RPG knob, for example, the **Input Range** key is automatically set to **Man**.

For PSA, when you use the internal preamplifier, Int Preamp, the

Key Reference

Front Panel Keys

selections using the **Max Total Pwr** key are not available, and the key is greyed-out.

For E4406A, when **Input Port** is set to **I/Q**, this key label changes to **I/Q Range**. It controls the maximum input voltages of the baseband I/Q input signals. The ranges are 130.0 mV, 250.0 mV, 500.0 mV and 1.0 V.

- **Input Atten** - Allows you to control the internal input attenuator setting. The range is 0 to 40 dB with 1 dB resolution. The **Input Atten** key reads out the actual hardware value that is used for the current measurement. If more than one input attenuator value is used in a single measurement, the value used at the carrier frequency is displayed. The **Input Atten** setting is coupled to the **Max Total Pwr** setting. Once you change the **Input Atten** setting with the RPG knob, for example, the **Input Range** key is automatically set to **Man**.

For PSA, when you use the internal preamplifier, **Int Preamp**, the electronic attenuator selections using the **Input Atten** key are not available, and the key is greyed-out. Use the mechanical attenuator under **More 1 of 2, Attenuator**, below.

For E4406A, this attenuator is located in front of the first down converter, therefore it is cannot be used for the baseband I/Q input signals.

- **Ext RF Atten** - Allows you to access the following menu to enter the external attenuation values. Either of the **Ext RF Atten** settings is coupled together with the **RF Input Range** setting. However, pressing **Ext RF Atten** does not switch the **RF Input Range** key to **Man**. This allows the instrument to display the measurement results referenced to the output of the UUT.

MS - Allows you to set an external attenuation value for MS tests. The range is -50.00 to +50.00 dB with 0.01 dB resolution.

BTS - Allows you to set an external attenuation value for BTS tests. The range is -50.00 to +50.00 dB with 0.01 dB resolution.

- **Int Preamp** - (For PSA, requires Option 1DS) Allows you to control the internal RF input preamplifier. The internal preamplifier provides +30 dB of gain and is useful for lower power measurements. The **Int Preamp** setting default is **Off**. RF power values displayed for these measurements are adjusted to compensate for the internal preamplifier gain, and indicate power levels at the input port. The preamplifier is only available for Modulation Accuracy (EVM and Peak Code Domain Error) measurements, QPSK EVM, and Code Domain measurements. If the **Int Preamp** is not available for a particular measurement, the key is greyed-out.

To avoid damaging the internal preamplifier, limit the total power applied to the RF input to $\leq +25\text{dBm}$.

When using the internal preamplifier, the electronic attenuator selections using the **Input Atten** key are not available, and the key is greyed-out. Use the mechanical attenuator under **More 1 of 2, Attenuator**, below.

- **Attenuator** - (For PSA, requires Option 1DS) When **Int Preamp** is set to **On**, this key allows you to control an internal mechanical input attenuator setting. The settings available are 0 dB, 10 dB, or 20 dB. The **Attenuator** key shows the actual hardware value that is used for the current measurement. The **Attenuator** setting is not coupled to the **Max Total Pwr** setting.

The **Attenuator** is only available for measurements which can use the **Int Preamp**: Modulation Accuracy (EVM and Peak Code Domain Error) measurements, QPSK EVM, and Code Domain measurements. If the **Int Preamp** is not available for a particular measurement, the key is greyed-out.

NOTE

The **Max Total Pwr** and **Input Atten** settings are coupled together, so changing the input **Max Total Pwr** setting by x dB changes the **Input Atten** setting by x dB. When you switch to a different measurement, the **Max Total Pwr** setting is kept constant, but the **Input Atten** may change if the two measurements have different mixer margins. Therefore, you can set the input attenuator manually, or you can set it indirectly by specifying the expected maximum power from the UUT.

| Input Default Settings | |
|--------------------------------------|-------------------------|
| Input Port | RF |
| I/Q Setup ^a (E4406A only) | (disabled) |
| RF Input Range | Auto ^b |
| Max Total Pwr | -15.00 dBm ^c |
| Input Atten | 0.00 dB ^c |
| Ext RF Atten: MS BTS | 0.00 dB 0.00 dB |
| Int Preamp ^d (PSA only): | OFF |

- This key is grayed out if **Input Port** is set to **RF**.
- Auto is not used for Spectrum (frequency domain) measurements.
- This may differ if the maximum input power is more than -15.00 dBm, or depending on the previous measurements.
- The preamplifier is only available for Modulation Accuracy (EVM and Peak Code Domain Error) measurements, QPSK EVM, and Code Domain measurements.

Measurement Keys

EDGE EVM (Error Vector Magnitude) Measurement Keys

NOTE Make sure the **EDGE EVM** measurement is selected under the **MEASURE** menu.

Key Path: **Meas Setup**

Meas Setup Key Menu

- **Avg Bursts On Off** - Allows you to select whether averages are made or not, and allows you to change the number of N averages that are made.
- **Avg Mode Exp Repeat** - Allows you to choose either exponential or repeat averaging. This selection only effects the averaging after the number of N averages is reached (set using the **Averages**, **Avg Bursts**, or **Avg Number** key).

Normal averaging: Normal (linear) averaging is always used until the specified number of N averages is reached. When **Measure** is set at **Single**, data acquisitions are stopped when the number of averages is reached - thus **Avg Mode** has no effect on single measurements.

Exponential averaging: When **Measure** is set at **Cont**, data acquisitions continue indefinitely. After N averages, exponential averaging is used with a weighting factor of N (the displayed average count stops at N). Exponential averaging weights new data more than old data, which allows tracking of slow-changing signals. The weighting factor N is set using the **Averages**, **Avg Bursts**, or **Avg Number** key.

Repeat averaging: When **Measure** is set at **Cont**, data acquisitions continue indefinitely. After N averages is reached, all previous result data is cleared and the average count is set back to 1. This is equivalent to being in **Measure Single** and pressing the **Restart** key when the Single measurement finishes.

- **Trig Source Key Menu**

Changing the selection in the **Trig Source** menu alters the trigger source for the selected measurement only. Not all of the selections are available for all measurements. Note that the **RF Burst (Wideband)**, **Video (IF Envlp)**, **Ext Front**, and **Ext Rear** menu keys found in the **Trigger** menu enable you to change settings to modify the delay, level, and slope for each of these trigger sources. Choose one of

the following sources:

Free Run (Immediate) - The trigger occurs at the time the data is requested, completely asynchronous to the RF or IF signal.

RF Burst (Wideband) - An internal wideband RF burst trigger that has an automatic level control for burst signals. It triggers on a level that is relative to the peak of the signal passed by the RF. If the data sent is all 0 bits, this trigger will give erratic or falsely high EVM results.

Video (IF Envelope) - An internal IF envelope trigger. It triggers on an absolute threshold level of the signal passed by the IF.

Ext Front - Activates the front panel external trigger input (**EXT TRIGGER INPUT**). The external trigger must be a signal between -5 and +5 volts.

Ext Rear - Activates the rear panel external trigger input (**TRIGGER IN**). The external trigger must be a signal between -5 and +5 volts.

Frame - Uses the internal frame clock to generate a trigger signal. The clock parameters are controlled under the **Mode Setup** key or the measurement firmware, but not both. See the specific measurement for details.

Line - activates an internal line trigger. Sweep triggers occur at intervals synchronized to the line frequency.

NOTE

Rear panel **TRIGGER 1 OUT** and **TRIGGER 2 OUT** connectors are coupled to the selected trigger source. These trigger outputs are always on the rising edge with a pulse width of at least 1 μ s.

- **Burst Sync**

Pressing the **Burst Sync** key allows you to choose the source used to synchronize the measurement to the “T0” point of the GSM or EDGE burst. The “T0” point is defined as the time point of the transition from bit 13 to bit 14 of the midamble training sequence for a given time slot. The

Burst Search Threshold setting (in the **Mode Setup** keys under **Trigger**) applies to both **Training Seq** and **RF Amptd**. Pressing the **Burst Sync** key brings up a menu with some or all of the following choices:

Training Seq - Synchronizes the measurement to the timing of the demodulated training sequence in the GSM burst. This is the most precise method, but requires a GMSK or EDGE burst with a valid TSC (Training Sequence Code). The “T0” point is determined by demodulation of the burst and successful identification of the TSC. “T0” is then found to within 1/10 bit.

RF Amptd - Synchronizes the measurement to the burst transition

of the measured RF carrier. “T0” is set to the 50% point between the start and end of the burst.

None - Use the start of the time record as the start of the useful part. “T0” is set to the middle of the useful part.

Polar Mod Sync - Select Polar Mod sync to perform Polar Modulation Analysis. This allows measurement of the AMPM offset which is shown on the Polar Vector and Data Bits displays.

- **Limits Key Menu**

Changing the selection in the **Limits** menu allows you to select limits from a set of standard settings, or allows you to set your own limits. The limits vary depending on whether the **Radio** is **MS** or **BS**:

Test Condition - Select either **Normal** or **Extreme** according to your test temperature conditions.

RMS EVM - Allows you to set a limit for RMS EVM in percent.

Peak EVM - Allows you to set a limit for Peak EVM in percent.

95%tile EVM - Allows you to set a limit for 95%tile EVM in percent.

I/Q Origin Offset - Allows you to set a limit for I/Q Origin Offset in dBc.

Freq Error - Allows you to set a limit for Freq Error in ppm.

- **Extreme Limits**

Changes the EVM test to the “extreme conditions” limits, as defined in the GSM 3GPP standards. See [“EDGE EVM \(Error Vector Magnitude\) Measurement Keys” on page 156](#) for details.

- **Droop Comp**

Turns on an algorithm to compensate for power droop in the EVM measurement. The power correction for droop is shown in dB/symbol across the 142 symbol burst. Droop compensation allows the measurement to minimize the contribution of amplifier power variations to the EVM results.

- **Freq Err Tol Range**

This key toggles between **Wide** and **Normal** settings for Frequency Error tolerance. To accurately demodulate more complex signals which require more stringent tolerance for frequency error, like multiple channels on the same carrier, select **Normal**. You can select **Wide** for use with signals that are simpler with greater frequency error tolerance.

- **Polar Mod Align**

This key toggles the correction for AMPM offset **ON** or **OFF** in the measured and displayed results of the EDGE EVM measurement.

You must have selected **Polar Mod Sync** in the **Burst Sync** menu to enable this correction.

The next table shows the factory default settings for error vector magnitude measurements.

Table 3-1 Error Vector Magnitude Measurement Defaults

| Measurement Parameter | Factory Default Condition |
|--|-------------------------------------|
| Avg Number | 10, On |
| Avg Mode | Exponential |
| Trigger Source | RF Burst (Wideband) |
| Burst Sync | Training Seq (TSC) |
| Trace/View | I/Q Measured Polar Vector |
| Extreme Limits | Off (test condition Normal) |
| Limits (BS): RMS EVM | 7%, normal 8%, extreme |
| Limits (MS): RMS EVM | 9%, normal 10%, extreme |
| Limits (BS): Peak EVM | 22%, normal 22%, extreme |
| Limits (MS): Peak EVM | 30%, normal 30%, extreme |
| Limits (BS): 95th percentile EVM | 11%, normal 11%, extreme |
| Limits (MS): 95th percentile EVM | 15%, normal 15%, extreme |
| Limits (BS): I/Q Origin Offset | -35 dBc, normal -35 dBc, extreme |
| Limits (MS): I/Q Origin Offset | -35 dBc, normal -35 dBc, extreme |
| Frequency Error (Base Normal Micro) | 0.05ppm, normal 0.05ppm, extreme |
| Frequency Error (Base Pico) | 0.1 ppm, normal 0.1 ppm, extreme |
| Frequency Error (Mobile) | 0.1 ppm, normal 0.1 ppm, extreme |
| Droop Comp | On |
| Freq Error Tol Range | Wide |

Trace/View Key Menu

Key Path: **Trace/View**

The **Trace/View** key accesses the menu which allows you to select the desired measurement view from the following selections:

- **Polar Vector** - The measured summary data is shown in the left window and the dynamic vector trajectory of the I/Q demodulated signal is shown as a vector display in the right window. The polar vector view presents a constantly changing display.

Measurement results displayed include: RMS EVM, Peak EVM, 95%tile EVM, Mag Error, Phase Error, Frequency Error, I/Q Origin Offset, Amplitude Droop, Training Sequence number (TSC), and T0 Offset. The AMPM Offset is displayed if **Polar Mod Sync** is selected in the **Burst Sync** menu.

Figure 3-3 EDGE EVM Result - Polar Vector View

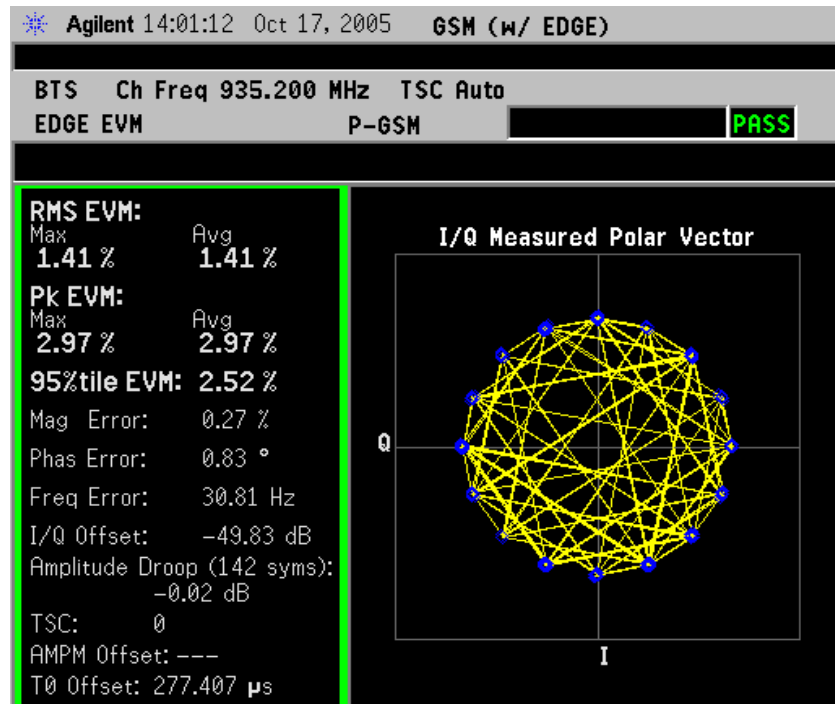

- **Polar Constln** - The measured summary data is shown in the left window and the dynamic constellation of the I/Q demodulated signal is shown as a polar display in the right window. See [Figure 3-4 on page 161](#).

Measurement results displayed include: RMS EVM, Peak EVM, 95%tile EVM, Mag Error, Phase Error, Frequency Error, I/Q Origin Offset, Amplitude Droop, Training Sequence number (TSC), and T0 Offset. The AMPM Offset is displayed if **Polar Mod Sync** is selected in the **Burst Sync** menu.

Figure 3-4 EDGE EVM Result- Polar Constln

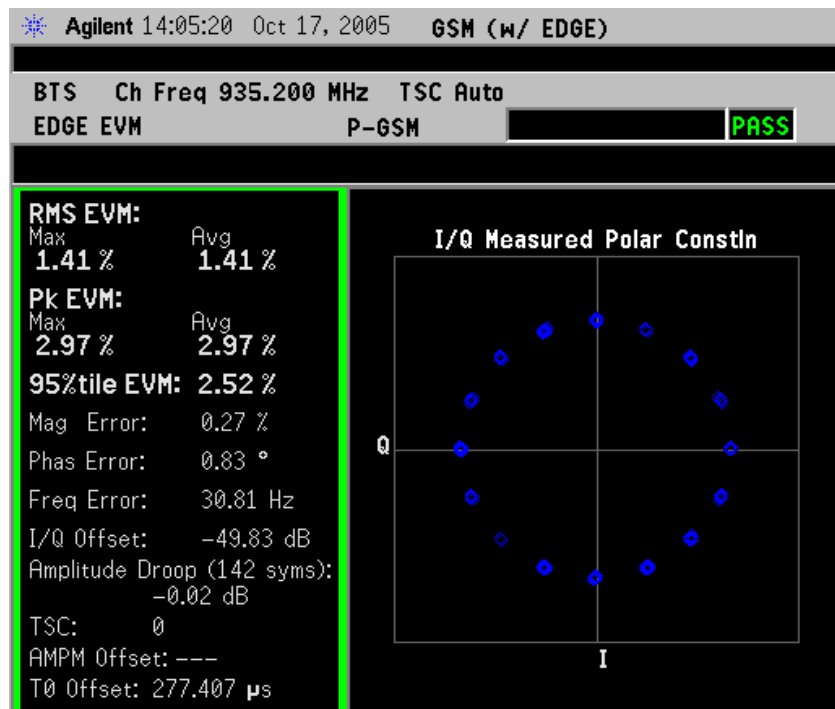

Key Reference
Measurement Keys

- **I/Q Error (Quad-View)** - Four display windows show EVM, Mag Error and Phase Error graphs, and the EVM summary data text.

Measurement results displayed include: RMS EVM, Peak EVM, 95%tile EVM, Mag Error, Phase Error, Frequency Error, I/Q Origin Offset, Amplitude Droop, Training Sequence number (TSC), and T0 Offset.

Figure 3-5 EDGE EVM Result - I/Q Error (Quad View)

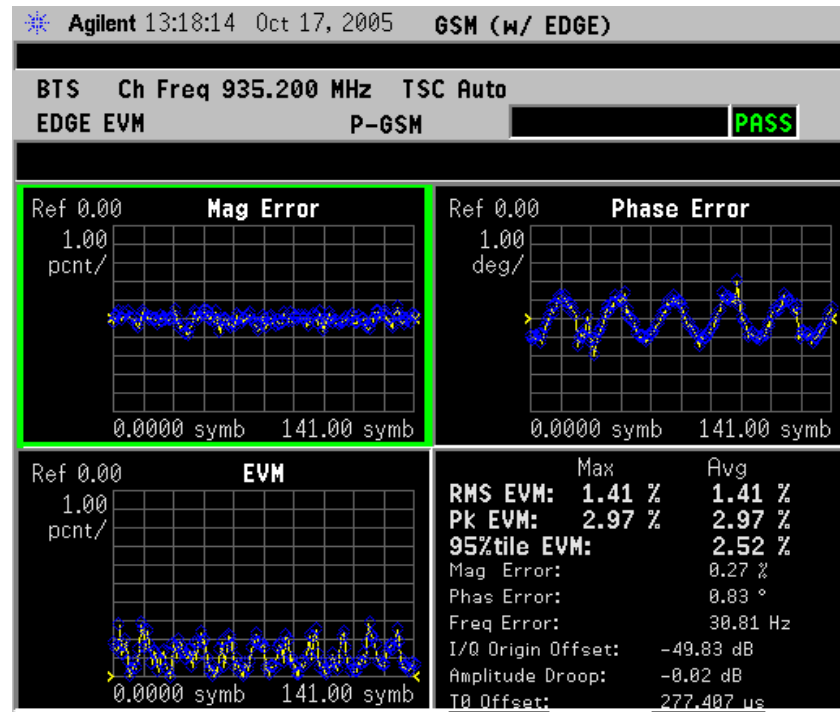

- **Data Bits** - See [Figure 3-6](#). Provides a view of the numeric results and data bits (in octal) with the sync word (TSC) highlighted.

Measurement results displayed include: RMS EVM, Peak EVM, 95%tile EVM, Mag Error, Phase Error, Frequency Error, I/Q Origin Offset, Amplitude Droop, Training Sequence number (TSC), and T0 Offset. The AMPM Offset is displayed if **Polar Mod Sync** is selected in the **Burst Sync** menu.

NOTE The data bits in this display are Symbol State bits, and do not represent encoded message data.

Figure 3-6 EDGE EVM Result - Data Bits View

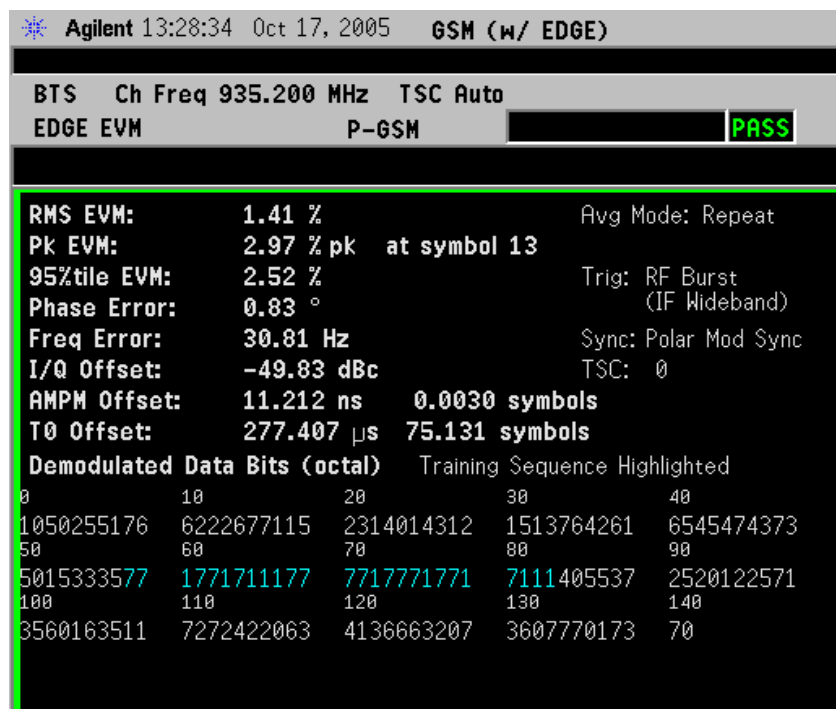

Display Key Menu

Key Path: **Display**

The **Display** key accesses the menu to allow the following selections for changing the graph displays:

- **Symbol Dots** - Allows you to toggle the symbol dots between **On** and **Off**. The default setting is **On**.
- **Time Offset Unit** - Allows you to select either units of Seconds or Symbols for Time for AMPM Offset measurements and corrections.

SPAN X Scale Key Menu

Key Path: **SPAN X Scale**

NOTE

When either EVM, Phase Error or Mag Error window is active in the I/Q Error (Quad-View) display, the **SPAN X Scale** key accesses the menu to allow the following selections:

- **Scale/Div** - Allows you to define the horizontal scale by changing the symbol value per division. The range is 1 to 500K symbols per division. The default setting is 14.1 symbols per division for BTS and MS device types.
- **Ref Value** - Allows you to set the symbol reference value ranging from 0 to 500K symbols. The default setting is 0.
- **Ref Position** - Allows you to set the reference position to either **Left**, **Ctr** (center) or **Right**. The default setting is **Left**.
- **Scale Coupling** - Allows you to toggle the scale coupling function between **On** and **Off**. The default setting is **On**. This function automatically determines the scale per division and reference value by the magnitude of the measurement results.

AMPLITUDE Y Scale Key Menu

Key Path: **AMPLITUDE Y Scale**

NOTE

When EVM, Phase Error, or Mag Error windows are active in the I/Q Error (Quad-View) display, the **AMPLITUDE Y Scale** key accesses a menu which allows the following selections:

- **Scale/Div** - Allows you to define the vertical scale by changing the value per division, with units, ranges, and default values depending on which display window is active.

Mag Error Window - Units are in Percent, range is from 0.1% to 50.0%, the default is 1.00%.

Phase Error Window - Units are in degrees, range is from 0.01 degrees to 3000 degrees, the default is 1.00 degrees.

EVM Window - Units are in Percent, range is from 0.1% to 50.0%, the default is 1.00%

Since the **Scale Coupling** default is set to **On**, the value displayed in this condition is automatically determined by the measurement results.

- **Ref Value** - Allows you to set the reference value, with units, ranges, and default values depending on which display window is active.

Mag Error Window - Units are in Percent, range is from -500.0%

to 500.0%, the default is 0.00%.

Phase Error Window - Units are in degrees, range is from -36000.0 degrees to 36000.0 degrees, the default is 0.00 degrees.

EVM Window - Units are in Percent, range is from -500.0% to 500.0%, the default is 0.00%.

- **Ref Position** - Allows you to set the reference position to **Top**, **Ctr** (center) or **Bot** (bottom).

Mag Error Window - The default is Ctr.

Phase Error Window - The default is Ctr.

EVM Window - The default is Top.

- **Scale Coupling** - Allows you to toggle the scale coupling function between **On** and **Off**. The default setting is **On**. This function automatically determines the scale per division and reference value by the magnitude of the measurement results.

EDGE Output RF Spectrum Measurement Keys

NOTE

This measurement is designed for EDGE. For the GSM Output RF Spectrum measurement see [“GMSK Output RF Spectrum Measurement Keys”](#) on page 187.

Make sure the **EDGE ORFS** measurement is selected under the **MEASURE** menu.

Meas Setup Key Menu

Key Path: **Meas Setup**

- **Avg Bursts On Off** - Allows you to select whether averages are made or not, and allows you to change the number of N averages that are made.
- **Meas Type** - Accesses a menu to choose the measurement that is optimized for the type of spectral distortion being investigated.

Mod & Switch - Performs both Modulation and Switching measurements, which measures the spectrum due to the 0.3 GMSK modulation and noise, and also measures Switching (transient) spectrum.

Modulation - Measures the spectrum optimized for distortion due to the 0.3 GMSK modulation and noise.

Switching - Measures the spectrum optimized for distortion due to switching transients (burst ramping).

Full Frame Modulation (FAST)- Improves measurement speed by acquiring a full frame of data prior to performing the FFT calculation. This feature can only be used when all slots in the transmitted frame are active. Use of an external trigger can enhance measurement speed when this feature is used. When **Full Frame Modulation (FAST)** is selected the current measurement defaults to the multi-offset measurement method; therefore the **Meas Method** key is grayed out and the **Single Offset** feature is not available.

- **Meas Method** - Accesses a menu to choose the measurement mode.

Multi-Offset - Automatically makes measurements at all offset frequencies in the selected list (**Standard**, **Short**, or **Custom**). (See table below.) Press the **Multi-Offset Freq List** key to select a list of offsets to measure.

Offset measurement results are displayed as tabular data, and may be viewed as either absolute powers in the Modulation Power and Switching Power views, or as powers relative to the margins and limit settings in the Modulation Margin and Limit and Switching Margin and Limit views. See [“Trace/View Key Menu”](#)

on page 173, and “EDGE ORFS Measurement Results” on page 65.

Single Offset (Examine) - Makes a measurement at a single offset frequency as set by the **Offset Freq** softkey.

Single offset measurement results are displayed in a time domain plot, with the measurement effective RBW shown as a gate by white vertical lines. See “EDGE ORFS Measurement Results” on page 65.

Swept - Makes a measurement using time-gated spectrum analysis to sweep the analyzer with the gate turned on for the desired portion of the burst only, as set by the **Modulation Ofs (offsets) & Limits** menu. The limits mask is applied to the spectrum plot, and the Worst Frequency parameters are displayed. This selection is only available if **Meas Type** is set to **Modulation**. See “EDGE ORFS Measurement Results” on page 65.

- **Multi-Offsets Freq List** - Accesses a menu to choose a predefined offset frequency list. Select a **Standard**, **Short**, or **Custom** list as shown in the table below. This selection is only available if **Meas Method** is set to **Multi-Offset**.

| List | Modulation Offsets (kHz) | Switching Transients Offsets (kHz) |
|----------|---|---|
| Standard | 100, 200, 250, 400, 600, 800, 1000, 1200, 1400, 1600, 1800, 3000, 6000 | 400, 600, 1200, 1800 |
| Short | 200, 250, 400, 600 1200, 1800 | 400, 600, 1200, 1800 |
| Custom | User-defined list that specifies: Offset Freq, RES BW, Limit Offsets Initialized to be the same as the standard list | User-defined list that specifies: Offset Freq, RES BW, Limit Offsets Initialized to be the same as the standard list |

- **Modulation Ofs & Limits** - Accesses a menu to set offset frequencies and limits for Modulation measurements. Settings made in this menu do not modify the GSM/EDGE standard settings. This selection is only available if **Multi-Offset Freq List** is set to **Custom**.

Offset - Select an offset by letter designation from **A** to **O**

Offset Freq - Turn a custom frequency offset **ON** or **OFF** and specify the offset frequency.

Res BW - Set the custom resolution bandwidth of the measurement. Narrower **Res BW** settings slow the measurement

Key Reference
Measurement Keys

speed, but give improved results for lower power signals.

Rel Limit Level Offset - Set a custom level limit offset from the standard-defined relative limit in dB. The range is +/- 50 dB.

Abs Limit Level Offset - Set a custom level limit offset from the standard-defined absolute limit in dB. The range is +/- 50 dB.

Apply Level Offset - Toggle this key to select which Limit Level Offsets are applied from the selections listed below:

Rel - Custom setting for **Rel Limit Level Offset** is applied to the standard-defined relative limit.

Abs - Custom setting for **Abs Limit Level Offset** is applied to the standard-defined absolute limit.

Both - Custom settings for **Rel Limit Level Offset** and **Abs Limit Level Offset** are applied.

- **Switching Ofs & Limits Multi-Ofs Freq List** accesses a menu to set offset frequencies and limits for Custom Switching measurements. Settings made in this menu do not modify the GSM/EDGE standard settings. This selection is only available if **Multi-Offset Freq List** is set to **Custom**.

Offset - Select an offset by letter designation from **A** to **O**

Offset Freq - Turn a custom frequency offset **ON** or **OFF** and specify the offset frequency.

Res BW - Set the custom resolution bandwidth of the measurement. The default is 30 kHz. Narrower **Res BW** settings slow the measurement speed, but give improved results for lower power signals.

Rel Limit Level Offset - Set a custom level offset from the standard-defined relative limit in dB. The range is +/- 50 dB.

Abs Limit Level Offset - Set a custom level limit offset from the standard-defined absolute limit in dB. The range is +/- 50 dB.

Apply Level Offset - Toggle this key to select which Limit Level Offsets are applied from the selections listed below:

Rel - Custom setting for **Rel Limit Level Offset** is applied to the standard-defined relative limit.

Abs - Custom settings for **Abs Limit Level Offset** is applied to the standard-defined absolute limit.

Both - Custom settings for **Rel Limit Level Offset** and **Abs Limit Level Offset** are applied.

- **Offset Freq** - Only available when **Measure** is set to **Single Offset (Examine)**. Offset frequencies can be entered using the RPG knob or the Data Entry keys.

- **Trig Source** - In this measurement, trigger source and burst sync are linked. Refer to the explanation under **Burst Sync**.
- **Burst Sync** - Synchronization is different on ORFS compared to other measurements. Since offsets may be very low power and acquired using very narrow filters, the burst edges are not well defined and there may be insufficient information to perform demodulation. Therefore all synchronization is performed on the carrier. The timing reference (“T0”) is then re-used on the offsets. Since “T0” on the carrier is determined with respect to the trigger point, the trigger point on the offsets is very important. Once “T0” is determined, the 50% and 90% points can be found.

Therefore, the trigger must be synchronous with respect to a rising edge of a burst. The RF Burst trigger does this if the offset is within about 7 MHz of the carrier. Remember that since the RF Burst trigger is wideband, the carrier will still cause the signal to trigger. As long as the trigger threshold remains constant, the trigger with respect to the burst remains constant. Since the Frame Trigger uses an internal frame timer (clock), its period is set so that it occurs synchronously with respect to the transmitting frame. If an external trigger is used, it is important that it is synchronous with the burst.

Because of these requirements, you may select the trigger source, but the measurement selects the required burst sync type based on your trigger source selection.

| Trigger Source | Measurement Defined Burst Sync |
|----------------|--------------------------------|
| Free Run | None |
| RF Burst | RF Amplitude |
| Ext Front | External |
| Ext Rear | External |
| Frame | Training Sequence |

NOTE

Video is not allowed as a trigger source because when the instrument is tuned to frequencies offset from the carrier, the video trigger threshold is not reached, due to low power levels at the offset.

- **Fast Avg** - Fast averaging is a technique developed by Agilent. The GSM standard specifies 50% to 90% portion of the burst, excluding the midamble, be measured. Since most offsets are measured in a 30 kHz filter, there is a lot of variation from burst to burst, hence the averaging.

The fast average method makes use of the 10% to 90% portion of the burst, excluding the midamble. The 10% to 50% portion of the burst

Key Reference
Measurement Keys

has statistically the same average power as the 50% to 90%. Therefore, measuring both portions from one burst is statistically the same as measuring 50% to 90% from two bursts. Now, two averages are completed with one burst. When Fast averaging is turned on, this doubles the speed of the measurement.

This method is only applicable on the modulation portion of the test, and only when averaging is enabled. The method is not available when Modulation and Switching are done at the same time.

- **Advanced** - Accesses a menu with the following keys:

NOTE Parameters under the Advanced key seldom need to be changed. Changes from default values may result in invalid measurement data.

Mod Avg - Choose between:

Pwr Avg (RMS)
Log-Pwr Avg (Video)

Switching Avg - Information only. When averaging is off, the peak value of the burst is retained. When averaging is on, the maximum of the peak values is retained.

Modulation Meas BWs - Accesses a menu with the following selections:

NOTE Changing these RBW settings modifies standard-defined values. Changes to these settings affect all EDGE ORFS measurements, except for Custom Multi-Offset measurements (where custom RBW setting in Modulation/Switching Ofs & Limits menu is used) and Modulation Swept measurements (where RBW is set to 30 kHz).

Carrier RBW
<1800 kHz Offset RBW
>=1800 kHz Offset RBW

VBW/RBW Ratio - Information only. Bandwidth ratio is fixed at 1.

Switching Meas BWs - Accesses a menu with the following selections:

Carrier RBW
<1800 kHz Offset RBW
>=1800 kHz Offset RBW

VBW/RBW Ratio - Information only. Switching ratio is fixed at 3.

Direct Time Break Freq - Selects the transition frequency (the first offset frequency) where the Direct Time Domain method is used instead of the FFT method. The Direct Time Domain offers a high dynamic range and is faster for making measurements at a few offset frequencies. The FFT method has a moderate dynamic range (generally sufficient when the RBW = 30 kHz). It is much faster for measuring at many offset frequencies

Fast Peak Det - Improves measurement speed by utilizing the running peak measurement capability of the DSP hardware without calculating averages separately. The previous method may be used for backwards compatibility by turning **Fast Peak Det** off.

Table 3-2

Output RF Spectrum Measurement Defaults

| Measurement Parameter | Factory Default Condition |
|---|---------------------------|
| Avg Bursts | 20 On |
| Avg Mode | Repeat |
| Meas Method | Multi-Offset |
| Meas Type | Modulation |
| Ofs Freq List | Short |
| Offset Freq (when single offset is selected) | 250.000 kHz |
| Trig Source | RF Burst |
| Burst Sync (information only) | RF Amptd |
| Fast Avg | On |
| Mod Method | Discrete |
| Advanced | |
| Mod Avg | Log-Pwr Avg (Video) |
| Switching Avg (information only) | Max of Peak |
| Direct Time Break Freq | 600.000 kHz |
| Fast Peak Det | On |
| Modulation Meas BWs | |
| Carrier RBW | 30.000 kHz |
| <1800 kHz Offset RBW | 30.000 kHz |
| ≥1800 kHz Offset RBW | 100.000 kHz |
| VBW/RBW Ratio (information only) | 1 |
| Switching Meas BWs | |
| Carrier RBW | 300.000 kHz |
| <1800 kHz Offset RBW | 30.000 kHz |
| ≥1800 kHz Offset RBW | 30.000 kHz |
| VBW/RBW Ratio (information only) | 3 |

Trace/View Key Menu

Key Path: Trace/View

- **Modulation Power** - When **Meas Method** is set to **Multi-Offset**, and **Meas Type** is set to **Modulation**, or **Mod and Switch**, measurement results may be viewed as absolute powers in tabular form. The data displays offsets from any of the **Multi-Offset Freq List** settings: **Standard**, **Short**, and **Custom**.

Figure 3-7 EDGE ORFS Result - Example (Short List)
Modulation Power View

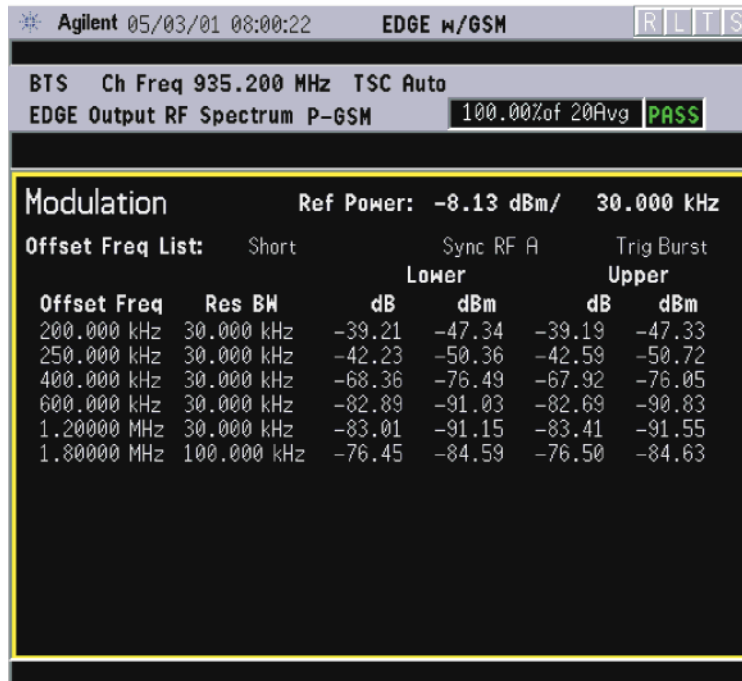

Key Reference
Measurement Keys

- **Modulation Margins & Limits**- When **Meas Method** is set to **Multi-Offset**, and **Meas Type** is set to **Modulation**, or **Mod and Switch**, measurement results may be viewed as relative powers in tabular form. The data displays offsets from any of the **Multi-Offset Freq List** settings: **Standard**, **Short**, and **Custom**, and shows the limit values selected by frequency, with the corresponding measurement result deltas.

Figure 3-8 EDGE ORFS Result - Example (Short List)
Modulation Margin & Limits View



- **Switching Power** - When **Meas Method** is set to **Multi-Offset**, and **Meas Type** is set to **Switching**, or **Mod and Switch**, measurement results may be viewed as absolute powers in tabular form. The data displays offsets from any of the **Multi-Offset Freq List** settings: **Standard**, **Short**, and **Custom**.

Figure 3-9 EDGE ORFS Result - Example (Short List)
Switching Power View

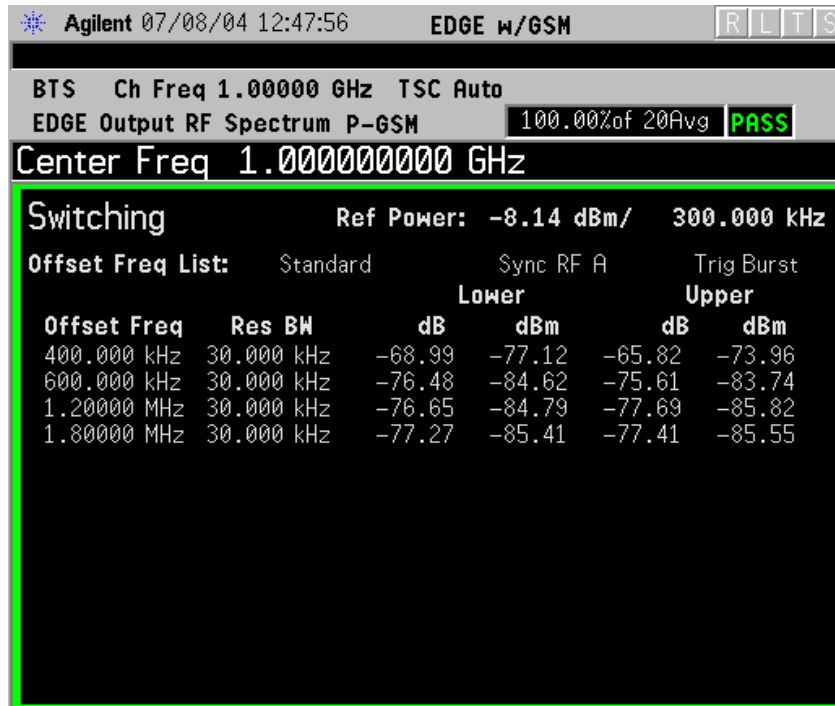

Key Reference
Measurement Keys

- **Switching Margins & Limits**- When **Meas Method** is set to **Multi-Offset**, and **Meas Type** is set to **Switching** or **Mod and Switch**, measurement results may be viewed as relative powers in tabular form. The data displays offsets from any of the **Multi-Offset Freq List** settings: **Standard**, **Short**, and **Custom**, and shows the limit values selected by frequency, with the corresponding measurement result deltas.

Figure 3-10 EDGE ORFS Result - Example (Short List)
Switching Margin & Limits View



NOTE

If the Single Offset measurement has been chosen, the **Trace/View** softkey is unavailable (grayed out) as both modulation and switching results are always displayed.

EDGE Power vs. Time Measurement Keys

NOTE Make sure the **EDGE Pwr vs Time** measurement is selected under the **MEASURE** menu.

Meas Setup Key Menu

Key Path: **Meas Setup**

- **Avg Bursts On Off** - Allows you to select whether averages are made or not, and allows you to change the number of N averages that are made.
- **Avg Mode Exp Repeat** - Allows you to choose either exponential or repeat averaging. This selection only effects the averaging after the number of N averages is reached (set using the **Averages**, **Avg Bursts**, or **Avg Number** key).

Normal averaging: Normal (linear) averaging is always used until the specified number of N averages is reached. When **Measure** is set at **Single**, data acquisitions are stopped when the number of averages is reached - thus **Avg Mode** has no effect on single measurements.

Exponential averaging: When **Measure** is set at **Cont**, data acquisitions continue indefinitely. After N averages, exponential averaging is used with a weighting factor of N (the displayed average count stops at N). Exponential averaging weights new data more than old data, which allows tracking of slow-changing signals. The weighting factor N is set using the **Averages**, **Avg Bursts**, or **Avg Number** key.

Repeat averaging: When **Measure** is set at **Cont**, data acquisitions continue indefinitely. After N averages is reached, all previous result data is cleared and the average count is set back to 1. This is equivalent to being in **Measure Single** and pressing the **Restart** key when the Single measurement finishes.

- **Avg Type** - Select the averaging type from the following selections: (Not all of the selections are available for all measurements)

Pwr Avg (RMS) - True power averaging that is equivalent to taking the RMS value of the voltage. It is the most accurate type of averaging.

Log-Pwr Avg (Video) - Simulates the traditional spectrum analyzer type of averaging by averaging the log of the power.

Mean - Averages the mean values.

Voltage Avg - Averages the voltage values.

Maximum - Keeps track of the maximum values.

Minimum - Keeps track of the minimum values.

Max & Min - Keeps track of the maximum and minimum values.

- **Meas Time** - allows you to measure more than one timeslot. Enter a value in integer increments of “slots” with a range of 1 to 8. The actual measure time in μs is set somewhat longer than the specified number of slots in order to view the complete burst.
- **Trig Source Key Menu**

Changing the selection in the **Trig Source** menu alters the trigger source for the selected measurement only. Not all of the selections are available for all measurements. Note that the **RF Burst (Wideband)**, **Video (IF Envlp)**, **Ext Front**, and **Ext Rear** menu keys found in the **Trigger** menu enable you to change settings to modify the delay, level, and slope for each of these trigger sources. Choose one of the following sources:

Free Run (Immediate) - The trigger occurs at the time the data is requested, completely asynchronous to the RF or IF signal.

RF Burst (Wideband) - An internal wideband RF burst trigger that has an automatic level control for burst signals. It triggers on a level that is relative to the peak of the signal passed by the RF. If the data sent is all 0 bits, this trigger will give erratic or falsely high EVM results.

Video (IF Envlp) - An internal IF envelope trigger. It triggers on an absolute threshold level of the signal passed by the IF.

Ext Front - Activates the front panel external trigger input (**EXT TRIGGER INPUT**). The external trigger must be a signal between -5 and $+5$ volts.

Ext Rear - Activates the rear panel external trigger input (**TRIGGER IN**). The external trigger must be a signal between -5 and $+5$ volts.

Frame - Uses the internal frame clock to generate a trigger signal. The clock parameters are controlled under the **Mode Setup** key or the measurement firmware, but not both. See the specific measurement for details.

Line - Activates an internal line trigger. Sweep triggers occur at intervals synchronized to the line frequency.

Rear panel **TRIGGER 1 OUT** and **TRIGGER 2 OUT** connectors are coupled to the selected trigger source. These trigger outputs are always on the rising edge with a pulse width of at least $1 \mu\text{s}$.

- **Burst Sync**

Pressing the **Burst Sync** key allows you to choose the source used to synchronize the measurement to the “T0” point of the GSM or EDGE

burst. The “T0” point is defined as the time point of the transition from bit 13 to bit 14 of the midamble training sequence for a given time slot. The **Burst Search Threshold** setting (in the **Mode Setup** keys under **Trigger**) applies to both **Training Seq** and **RF Amptd**. Pressing the **Burst Sync** key brings up a menu with some or all of the following choices:

Training Seq - Synchronizes the measurement to the timing of the demodulated training sequence in the GSM burst. This is the most precise method, but requires a GMSK or EDGE burst with a valid TSC (Training Sequence Code). The “T0” point is determined by demodulation of the burst and successful identification of the TSC. “T0” is then found to within 1/10 bit.

RF Amptd - Synchronizes the measurement to the burst transition of the measured RF carrier. “T0” is set to the 50% point between the start and end of the burst.

None - The start of the time record is the start of the measured data. Set **Trigger Delay** as needed to capture the data to be measured.

- **Pwr Cntrl Lvl** - Used to indicate the output power of the transmitter; in MS testing transmitter output power variations affect the mask (in BTS testing the mask is not affected). The appropriate power level for measuring the device under test corresponds with the transmitter power control level setting. Enter a value between 0 and 40.

NOTE

Parameters that are under the **Advanced** key seldom need to be changed. Any changes from the default values may result in invalid measurement data.

- **Advanced** - Accesses a menu to change the following parameters:

RBW Filter - Chooses the type of filter, either **Gaussian** or **Flat** (Flatop). Gaussian is the best choice when looking at the overall burst or the rising and falling edges, as it has excellent pulse response. If you want to precisely examine just the useful part of the burst, choose **Flat**.

Res BW - Sets the resolution bandwidth.

Timeslot Length - Timeslot configurations can appear in two forms. When making Multi-slot measurements, select a type of timeslot length configuration from the following list:

All 156.25 symb - A uniform limit mask of 156.25 symbols in length is applied to all slots.

157/156 symb - A limit mask of 157 symbols in length is applied to slots 0 and 4, while a limit mask of 156 symbols in length is applied to slots 1, 2, 3, 5, 6 and 7.

Table 3-3

EDGE Power vs. Time Measurement Defaults

| Measurement Parameter | Factory Default Condition |
|-----------------------|---------------------------|
| Avg Bursts | 10 Off |
| Avg Mode | Exp |
| Avg Type | Pwr Avg (RMS) |
| Meas Time | 1 Slot |
| Timeslot | 0 |
| Trig Source | RF Burst (Wideband) |
| Burst Sync | Training Seq |
| Advanced | |
| RBW Filter | Gaussian |
| Res BW | 500.000 kHz |

Trace/View Key Menu

Key Path: **Trace/View**

- **Burst** - Views the entire burst of interest as determined by the current trigger source, burst sync, training sequence, and timeslot settings. To view a different burst of interest you must set these parameters for the selected timeslot. To view multiple slots use the **Multi-Slot** key described below. See [Figure 3-11](#) on page 181

Figure 3-11 EDGE Power vs. Time Result - Burst View

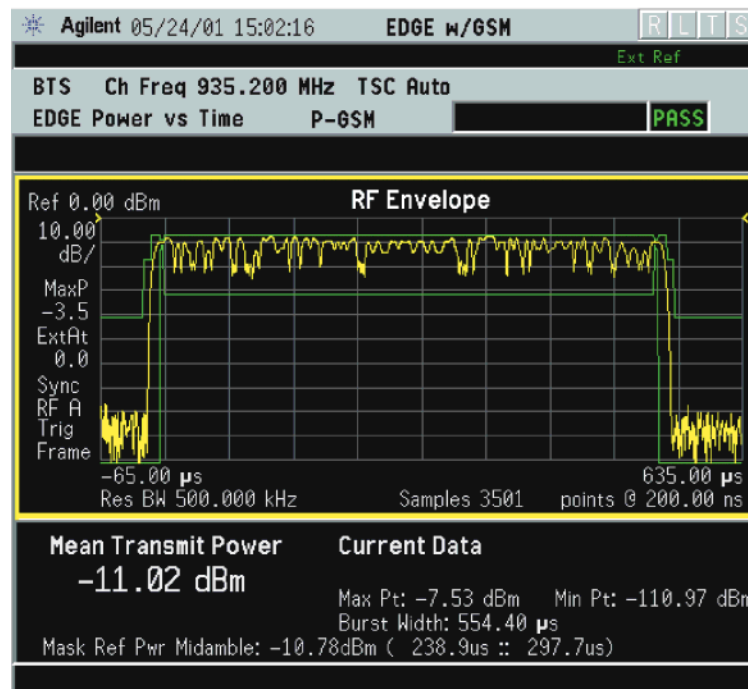

- **Rise & Fall** - Zooms in on the rising and falling portions of the burst being tested. See [Figure 3-12](#) on page 182.

NOTE

When **Rise & Fall** is selected, the limit test is still performed on the entire burst (viewed using the **Burst** menu).

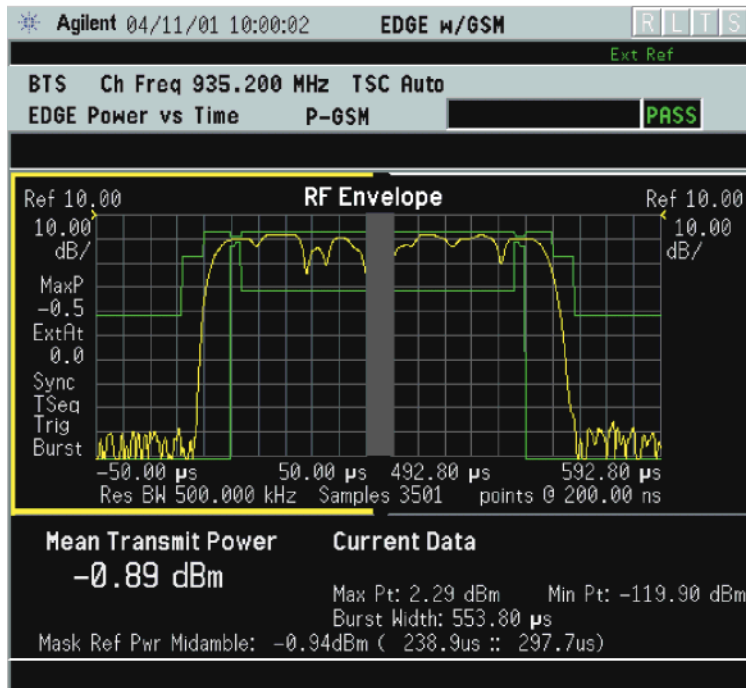
Figure 3-12 EDGE Power vs. Time Result - Rise & Fall View

- **Multi-Slot** - Views the entire sweep as specified by the current **Meas Time** setting. Power levels for each active slot are listed in a table below the timeslot display. Also shown in the table under **1st Error Pt.** is the point in time at which the signal level first exceeds the limit, which helps to identify the slot where a failure first occurs. See [Figure 3-13 on page 183](#).

Figure 3-13 EDGE Result - Multi-Slot View

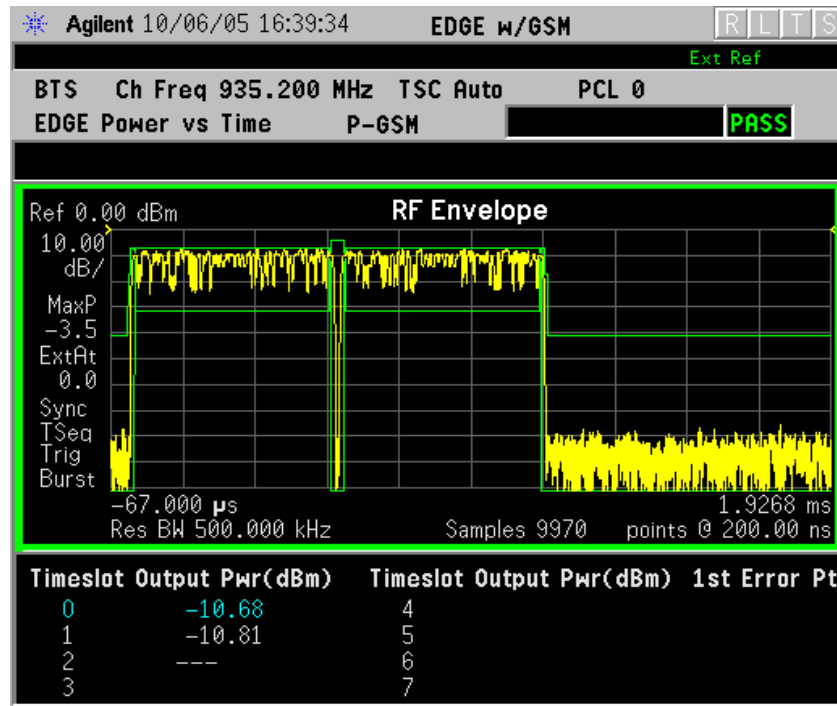

Display Key Menu

Key Path: **Display**

The **Display** key allows you to turn the limit mask on and off. This also disables the mask limit test, but still calculates the power in the useful part.

EDGE Tx Band Spur Measurement Keys

| | |
|-------------|--|
| NOTE | Make sure the EDGE Tx Band Spur measurement is selected under the Measure menu. |
|-------------|--|

Meas Setup Key Menu

Key Path: **Meas Setup**

- **Avg Number** - Allows you to select whether averages are made or not, and to change the number of N averages that are made.
- **Avg Mode Exp Repeat** - Allows you to choose either exponential or repeat averaging. This selection only effects the averaging after the number of N averages is reached (set using the **Averages**, **Avg Bursts**, or **Avg Number** key).

Normal averaging - Normal (linear) averaging is always used until the specified number of N averages is reached. When **Measure** is set at **Single**, data acquisitions are stopped when the number of averages is reached, and **Avg Mode** has no effect on single measurements.

Exponential averaging - When **Measure** is set at **Cont**, data acquisitions continue indefinitely. After N averages, exponential averaging is used with a weighting factor of N (the displayed average count stops at N). Exponential averaging weights new data more than old data, which allows tracking of slow-changing signals. The weighting factor N is set using the **Averages**, **Avg Bursts**, or **Avg Number** key.

Repeat averaging - When **Measure** is set at **Cont**, data acquisitions continue indefinitely. After N averages is reached, all previous result data is cleared and the average count is set back to 1. This is equivalent to being in **Measure Single** and pressing the **Restart** key when the Single measurement finishes.

- **Avg Type** - Select the averaging type from the following selections: (Not all of the selections are available for all measurements)

Pwr Avg (RMS) - True power averaging that is equivalent to taking the RMS value of the voltage. It is the most accurate type of averaging.

Log-Pwr Avg (Video) - Simulates the traditional spectrum analyzer type of averaging by averaging the log of the power.

Mean - Averages the mean values.

Voltage Avg - Averages the voltage values.

Maximum - Keeps track of the maximum values.

Minimum - Keeps track of the minimum values.

Max & Min - Keeps track of the maximum and minimum values.

- **Meas Type**- Selects measurement style as defined by menu keys below:

Full - In Continuous Measure mode, the instrument repeatedly performs a full search of all segments.

Examine- In Continuous Measure mode, after doing one full search across all segments, the instrument selects the worst segment and continuously updates that segment.

- **Limit** - set the absolute or relative limit. The limit range is from -200 dBm to 100 dBm.

dBm - Absolute limit

dBc - Relative to Mean Transmit Power.

Table 3-4

EDGE Tx Band Spur Measurement Defaults

| Measurement Parameter | Factory Default Condition |
|-----------------------|---------------------------|
| Avg Number | 30 On |
| Avg Mode | Repeat |
| Avg Type | Maximum |
| Meas Type | Full |
| Limit | -36 dBm |

Trace/View Key Menu

Key Path: **Trace/View**

- **Lower Segment** - Select lower Tx band edge to -6 MHz offset from the channel frequency for display.
- **Lower Adj Segment** - Select -6 MHz to -1.8 MHz offset from the channel frequency for display.
- **Upper Adj Segment** - Select +1.8 MHz to +6 MHz offset from the channel frequency for display.
- **Upper Segment** - +6 MHz offset from the channel frequency to the upper Tx band edge for display.

Key Reference
Measurement Keys

Results Figure 3-14 EDGE Tx Band Spur Result - Upper Adj Segment

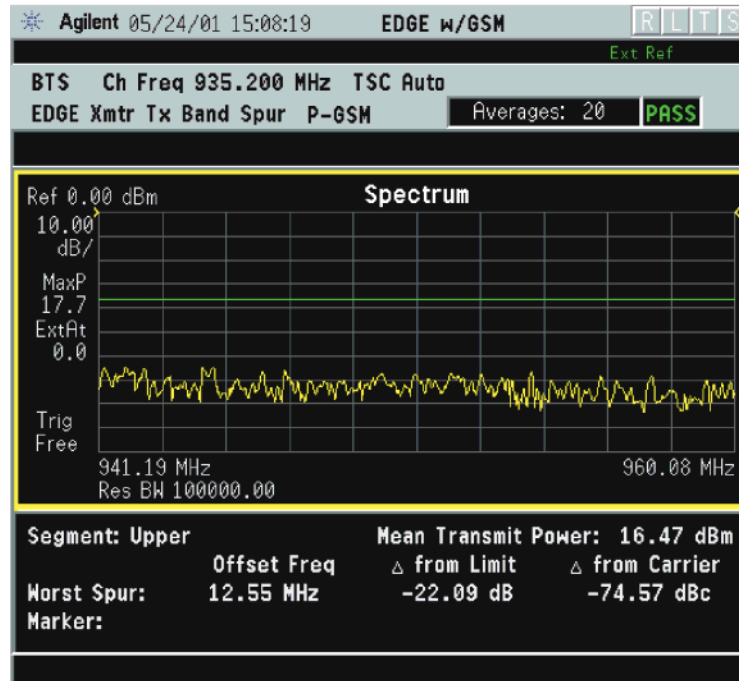

GMSK Output RF Spectrum Measurement Keys

NOTE

Make sure the Output RF Spectrum measurement is selected under the **Measure** menu.

Meas Setup Key Menu

Key Path: **Meas Setup**

- **Avg Bursts On Off** - Allows you to select whether averages are made or not, and allows you to change the number of N averages that are made.
- **Meas Type** - Accesses a menu to choose the measurement that is optimized for the type of spectral distortion being investigated.

Mod & Switch - Performs both Modulation and Switching measurements, which measures the spectrum due to the 0.3 GMSK modulation and noise, and also measures the Switching (transient) spectrum.

Modulation - Measures the spectrum optimized for distortion due to the 0.3 GMSK modulation and noise.

Switching - Measures the spectrum optimized for distortion due to switching transients (burst ramping).

Full Frame Modulation (FAST)- Improves measurement speed by acquiring a full frame of data prior to performing the FFT calculation. This feature can only be used when all slots in the transmitted frame are active. Use of an external trigger can enhance measurement speed when this feature is used. When **Full Frame Modulation (FAST)** is selected, the current measurement defaults to the multi-offset measurement method; therefore, the **Meas Method** key is grayed out and the **Single Offset** feature is not available.

- **Meas Method** - Accesses a menu to choose the measurement mode.
 - Multi-Offset** - Automatically makes measurements at all offset frequencies in the selected list (**Standard**, **Short**, or **Custom**). (See table below.) Press the **Multi-Offset Freq List** key to select a list of offsets to measure.
 - Single Offset (Examine)** - Makes a measurement at a single offset frequency as set by the **Single Offset Freq** softkey.
 - Swept** - Makes a measurement using time-gated spectrum analysis to sweep the analyzer with the gate turned on for the desired portion of the burst only, as set by the **Modulation Of** (offsets) & **Limits** menu. This selection is only available if **Meas Type** is set to **Modulation**.

Key Reference
Measurement Keys

- **Multi-Offsets Freq List** - Accesses a menu to choose a predefined offset frequency list. Select a **Standard**, **Short**, or **Custom** list as shown in the table below. This selection is only available if **Meas Method** is set to **Multi-Offset**.

| List | Modulation Offsets (kHz) | Switching Transients Offsets (kHz) |
|-----------------|---|---|
| Standard | 100, 200, 250, 400, 600, 800, 1000, 1200, 1400, 1600, 1800, 3000, 6000 | 400, 600, 1200, 1800 |
| Short | 200, 250, 400, 600 1200, 1800 | 400, 600, 1200, 1800 |
| Custom | User-defined list that specifies: Offset Freq, RES BW, Limit Offsets Initialized to be the same as the standard list | User-defined list that specifies: Offset Freq, RES BW, Limit Offsets Initialized to be the same as the standard list |

- **Modulation Ofs & Limits** - Accesses a menu to set offset frequencies and limits for Modulation measurements. Settings made in this menu do not modify the GSM/EDGE standard settings. This selection is only available if **Multi-Offset Freq List** is set to **Custom**.

Offset - Select an offset by letter designation from **A** to **O**

Offset Freq - Turn a custom frequency offset **ON** or **OFF** and specify the offset frequency.

Res BW - Set the custom resolution bandwidth of the measurement. Narrower **Res BW** settings slow the measurement speed, but give improved results for lower power signals.

Rel Limit Level Offset - Set a custom level limit offset from the standard-defined relative limit in dB. The range is +/- 50 dB.

Abs Limit Level Offset - Set a custom level limit offset from the standard-defined absolute limit in dB. The range is +/- 50 dB.

Apply Level Offset - Toggle this key to select which Limit Level Offsets are applied from the selections listed below:

Rel - Custom setting for **Rel Limit Level Offset** is applied to the standard-defined relative limit.

Abs - Custom setting for **Abs Limit Level Offset** is applied to the standard-defined absolute limit.

Both - Custom settings for **Rel Limit Level Offset** and **Abs Limit Level Offset** are applied.

- **Switching Ofs & Limits Multi-Ofs Freq List** - Accesses a menu to set offset frequencies and limits for Custom Switching measurements. Settings made in this menu do not modify the GSM/EDGE standard settings. This selection is only available if **Multi-Offset Freq List** is set to **Custom**.

Offset - Select an offset by letter designation from **A** to **O**

Offset Freq - Turn a custom frequency offset **ON** or **OFF** and specify the offset frequency.

Res BW - Set the custom resolution bandwidth of the measurement. The default is 30 kHz. Narrower **Res BW** settings slow the measurement speed, but give improved results for lower power signals.

Rel Limit Level Offset - Set a custom level offset from the standard-defined relative limit in dB. The range is +/- 50 dB.

Abs Limit Level Offset - Set a custom level limit offset from the standard-defined absolute limit in dB. The range is +/- 50 dB.

Apply Level Offset - Toggle this key to select which Limit Level Offsets are applied from the selections listed below:

Rel - Custom setting for **Rel Limit Level Offset** is applied to the standard-defined relative limit.

Abs - Custom setting for **Abs Limit Level Offset** is applied to the standard-defined absolute limit.

Both - Custom settings for **Rel Limit Level Offset** and **Abs Limit Level Offset** are applied.

- **Offset Freq** - Only available when **Measure** is set to **Single Offset (Examine)**. Offset frequencies can be entered using the RPG knob or the Data Entry keys.
- **Trig Source** - In this measurement, trigger source and burst sync are linked. Refer to the explanation under **Burst Sync**.
- **Burst Sync** - Synchronization is different on ORFS compared to other measurements. Since offsets may be very low power and acquired using very narrow filters, the burst edges are not well defined and there is not enough information to perform a demodulation. Therefore all synchronization is performed on the carrier. The timing reference ("T0") is then re-used on the offsets. Since "T0" on the carrier is determined with respect to the trigger point, the trigger point on the offsets is very important. Once "T0" is determined, the 50% and 90% points can be found.

Therefore, the trigger must be synchronous with respect to a rising edge of a burst. The RF Burst trigger does this if the offset is within about 7 MHz of the carrier. Remember that since the RF Burst trigger is wideband, the carrier will still cause the signal to trigger.

Key Reference
Measurement Keys

Assuming the trigger threshold remains constant, the trigger with respect to the burst will remain constant. Since the Frame Trigger uses an internal frame timer (clock), its period is set so that it occurs synchronously with respect to the transmitting frame. If an external trigger is used, it is important that it is synchronous with the burst.

Because of these requirements, only the trigger source can be selected, while the measurement selects the burst sync type based on the trigger source.

| Trigger Source | Measurement Defined Burst Sync |
|----------------|--------------------------------|
| Free Run | None |
| RF Burst | RF Amplitude |
| Ext Front | External |
| Ext Rear | External |
| Frame | Training Sequence |

NOTE

Video is not allowed as a trigger source selection, because when the instrument is tuned to offset frequencies away from the carrier, the video trigger threshold cannot be reached, due to the low power level at the offset.

- **Fast Avg** - Fast averaging is a technique developed by HP/Agilent. The GSM standard specifies 50% to 90% portion of the burst, excluding the midamble, be measured. Since most offsets are measured in a 30 kHz filter, there is a lot of variation from burst to burst, hence the averaging.

The fast average method makes use of the 10% to 90% portion of the burst, excluding the midamble. The 10% to 50% portion of the burst has statistically the same average power as the 50% to 90%. Therefore, measuring both portions from one burst is statistically the same as measuring 50% to 90% from two bursts. Now, two averages are completed with one burst. When averaging is turned on, this doubles the speed of the measurement.

This method is only applicable on the modulation portion of the test, and only when averaging is enabled. The method is not available when Modulation and Switching are done at the same time.

- **Advanced** - Accesses a menu with the following keys:

NOTE

Parameters under the Advanced key seldom need to be changed. Changes from default values may result in invalid measurement data.

Mod Avg - choose between:

Pwr Avg (RMS)
Log-Pwr Avg (Video)

Switching Avg - Information only. When averaging is off, the peak value of the burst is retained. When averaging is on, the maximum of the peak values is retained.

Modulation Meas BWs - Accesses a menu with the following selections:

NOTE

Changing these RBW settings modifies standard-defined values. Changes to these settings affects all EDGE ORFS measurements, except for Custom Multi-Offset measurements (where custom RBW setting in Modulation/Switching Ofs & Limits menu is used) and Modulation Swept measurements (where RBW is set to 30 kHz).

Carrier RBW
<1800 kHz Offset RBW
>=1800 kHz Offset RBW

VBW/RBW Ratio - Information only. Bandwidth ratio is fixed at 1.

Switching Meas BWs - Accesses a menu with the following selections:

Carrier RBW
<1800 kHz Offset RBW
>=1800 kHz Offset RBW

VBW/RBW Ratio - Information only. Switching ratio is fixed at 3.

Direct Time Break Freq - Selects the transition frequency (the first offset frequency) where the Direct Time Domain method is used instead of the FFT method. The Direct Time Domain offers a high dynamic range and is faster for making measurements at a few offset frequencies. The FFT method has a moderate dynamic range (generally sufficient when the RBW = 30 kHz). It is much faster for measuring at many offset frequencies.

Fast Peak Det - Improves measurement speed by utilizing the running peak measurement capability of the DSP hardware without calculating averages separately. The previous method may be used for backwards compatibility by turning **Fast Peak Det** off.

Table 3-5

Output RF Spectrum Measurement Defaults

| Measurement Parameter | Factory Default Condition |
|---|---------------------------|
| Avg Bursts | 20 On |
| Avg Mode | Repeat |
| Meas Method | Multi-Offset |
| Meas Type | Modulation |
| Ofs Freq List | Short |
| Offset Freq (when single offset is selected) | 250.000 kHz |
| Trig Source | RF Burst |
| Burst Sync (information only) | RF Amptd |
| Fast Avg | On |
| Mod Method | Discrete |
| Advanced | |
| Mod Avg | Log-Pwr Avg (Video) |
| Switching Avg (information only) | Max of Peak |
| Direct Time Break Freq | 600.000 kHz |
| Fast Peak Det | On |
| Modulation Meas BWs | |
| Carrier RBW | 30.000 kHz |
| <1800 kHz Offset RBW | 30.000 kHz |
| ≥1800 kHz Offset RBW | 100.000 kHz |
| VBW/RBW Ratio (information only) | 1 |
| Switching Meas BWs | |
| Carrier RBW | 300.000 kHz |
| <1800 kHz Offset RBW | 30.000 kHz |
| ≥1800 kHz Offset RBW | 30.000 kHz |
| VBW/RBW Ratio (information only) | 3 |

Trace/View Key Menu

Key Path: Trace/View

- **Modulation Power** - When **Meas Method** is set to **Multi-Offset**, and **Meas Type** is set to **Modulation**, or **Mod and Switch**, measurement results may be viewed as absolute powers in tabular form. The data displays offsets from any of the **Multi-Offset Freq List** settings: **Standard**, **Short**, and **Custom**.

Figure 3-15 GMSK ORFS Result - Example (Short List) Modulation Power View

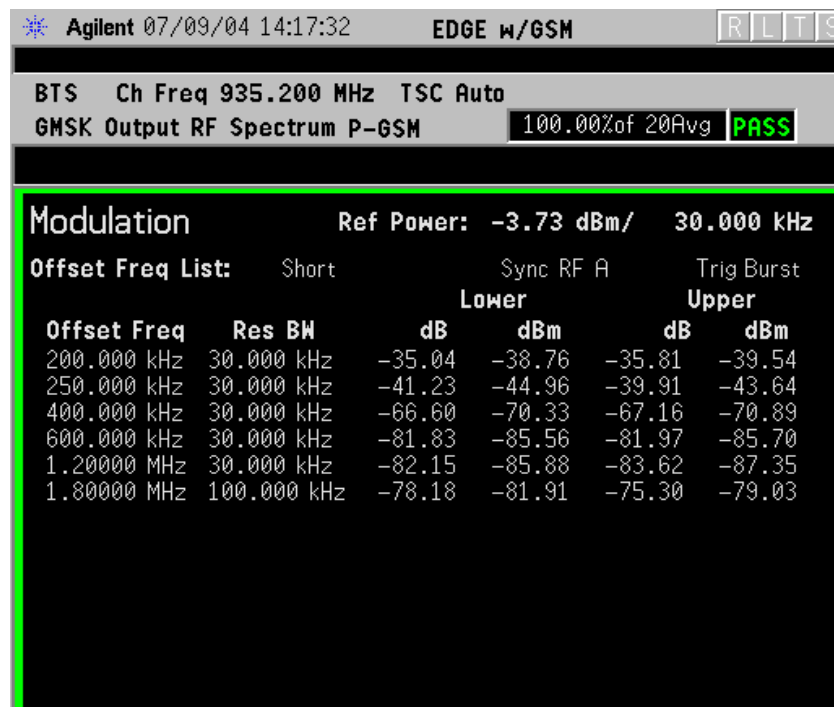

Key Reference
Measurement Keys

- **Modulation Margins & Limits**- When **Meas Method** is set to **Multi-Offset**, and **Meas Type** is set to **Modulation**, or **Mod and Switch**, measurement results may be viewed as relative powers in tabular form. The data displays offsets from any of the **Multi-Offset Freq List** settings: **Standard**, **Short**, and **Custom**, and shows the limit values selected by frequency, with the corresponding measurement result deltas.

Figure 3-16 GMSK ORFS Result - Example (Short List)
Modulation Margin & Limits View

Agilent 07/09/04 14:19:32 EDGE W/GSM R L T S

BTS Ch Freq 935.200 MHz TSC Auto
GMSK Output RF Spectrum P-GSM 100.00% of 20Avg PASS

| Modulation | | Ref Power: -3.73 dBm/ | | 30.000 kHz | | | |
|-------------------|-------------|-----------------------|--------|------------|---------|------------|--|
| Offset Freq List: | | Short | | Sync RF A | | Trig Burst | |
| Offset Freq | Res BW | Δ from Limit dB | | Limit | | | |
| | | Lower | Upper | Rel dB | Abs dBm | | |
| 200.000 kHz | 30.000 kHz | -5.04 | -5.81 | -30.00 | -65.00 | | |
| 250.000 kHz | 30.000 kHz | -8.23 | -6.91 | -33.00 | -65.00 | | |
| 400.000 kHz | 30.000 kHz | -6.60 | -7.16 | -60.00 | -65.00 | | |
| 600.000 kHz | 30.000 kHz | -21.83 | -21.97 | -60.00 | -65.00 | | |
| 1.20000 MHz | 30.000 kHz | -20.88 | -22.35 | -63.00 | -65.00 | | |
| 1.80000 MHz | 100.000 kHz | -16.91 | -14.03 | -65.00 | -65.00 | | |

- **Switching Power** - When **Meas Method** is set to **Multi-Offset**, and **Meas Type** is set to **Switching**, or **Mod and Switch**, measurement results may be viewed as absolute powers in tabular form. The data displays offsets from any of the **Multi-Offset Freq List** settings: **Standard**, **Short**, and **Custom**.

Figure 3-17 GMSK ORFS Result - Example (Short List) Switching Power View

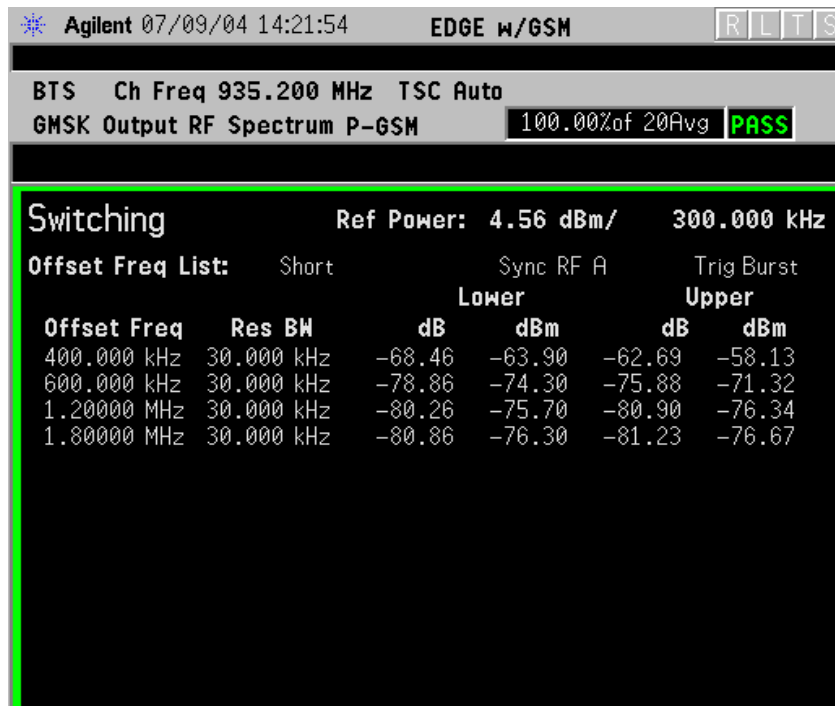

Key Reference
Measurement Keys

- **Switching Margins & Limits**- When **Meas Method** is set to **Multi-Offset**, and **Meas Type** is set to **Switching** or **Mod and Switch**, measurement results may be viewed as relative powers in tabular form. The data displays offsets from any of the **Multi-Offset Freq List** settings: **Standard**, **Short**, and **Custom**, and shows the limit values selected by frequency, with the corresponding measurement result deltas.

Figure 3-18 GMSK ORFS Result - Example (Short List)
Switching Margin & Limits View

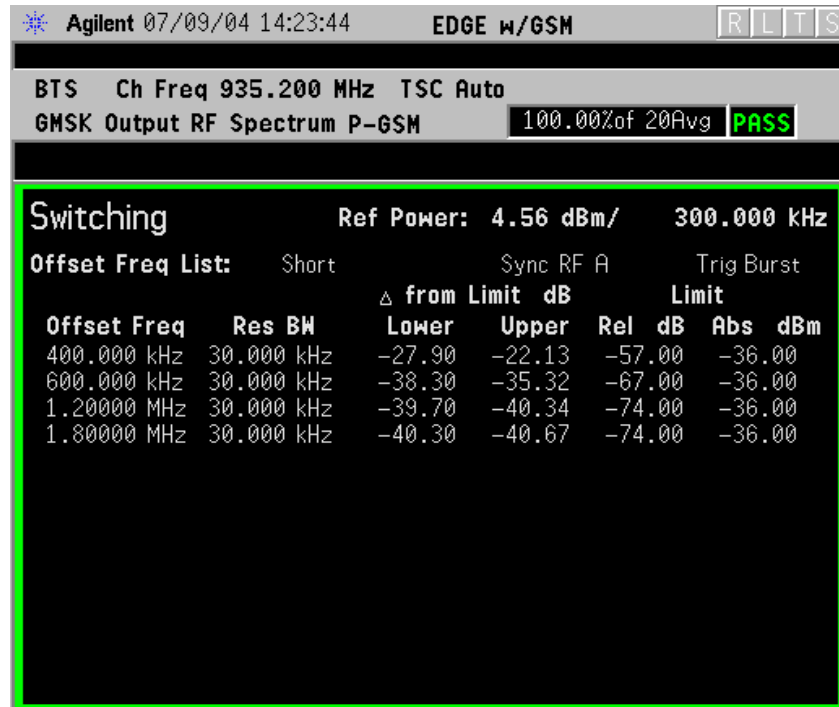

NOTE

If the Single Offset measurement has been chosen, the **Trace/View** softkey is unavailable (grayed out) as both modulation and switching results are always displayed.

GMSK Phase and Frequency Error Measurement Keys

NOTE

This measurement is designed for GSM only.

Make sure the **GMSK Phase and Freq** measurement is selected under the **MEASURE** menu.

Meas Setup Key Menu

Key Path: **Meas Setup**

- **Avg Bursts On Off** - Allows you to select whether averages are made or not, and allows you to change the number of N averages that are made.
- **Avg Mode Exp Repeat** - Allows you to choose either exponential or repeat averaging. This selection only effects the averaging after the number of N averages is reached (set using the **Averages**, **Avg Bursts**, or **Avg Number** key).

Normal averaging - Normal (linear) averaging is always used until the specified number of N averages is reached. When **Measure** is set at **Single**, data acquisitions are stopped when the number of averages is reached - thus **Avg Mode** has no effect on single measurements.

Exponential averaging - When **Measure** is set at **Cont**, data acquisitions continue indefinitely. After N averages, exponential averaging is used with a weighting factor of N (the displayed average count stops at N). Exponential averaging weights new data more than old data, which allows tracking of slow-changing signals. The weighting factor N is set using the **Averages**, **Avg Bursts**, or **Avg Number** key.

Repeat averaging - When **Measure** is set at **Cont**, data acquisitions continue indefinitely. After N averages is reached, all previous result data is cleared and the average count is set back to 1. This is equivalent to being in **Measure Single** and pressing the **Restart** key when the Single measurement finishes.

- **Avg Type** - Select the averaging type from the following selections: (Not all of the selections are available for all measurements)

Pwr Avg (RMS) - True power averaging that is equivalent to taking the RMS value of the voltage. It is the most accurate type of averaging.

Log-Pwr Avg (Video) - Simulates the traditional spectrum analyzer type of averaging by averaging the log of the power.

Mean - Averages the mean values.

Key Reference
Measurement Keys

Voltage Avg - Averages the voltage values.

Maximum - Keeps track of the maximum values.

Minimum - Keeps track of the minimum values.

Max & Min - Keeps track of the maximum and minimum values.

- **Limits** - Select custom values for limits from the following selections:

NOTE

The selections available for custom limits depend on the settings for **Radio**, **Device** and if **BTS** is selected, for **BTS Type**.

RMS Phase Error - Select a value for RMS Phase Error limit in degrees.

Peak Phase Error - Select a value for Peak Phase Error limit in degrees.

Freq Error - Select a value for Frequency Error limit in ppm.

- **Trig Source Key Menu**

NOTE

Changing the selection in the **Trig Source** menu alters the trigger source for the selected measurement only.

Free Run (Immediate) - The trigger occurs at the time the data is requested, completely asynchronous to the RF or IF signal.

RF Burst (Wideband) - An internal wideband RF burst trigger that has an automatic level control for burst signals. It triggers on a level that is relative to the peak of the signal passed by the RF. If the data sent is all 0 bits, this trigger will give erratic or falsely high EVM results.

Video (IF Envp) - An internal IF envelope trigger. It triggers on an absolute threshold level of the signal passed by the IF.

Ext Front - Activates the front panel external trigger input (**EXT TRIGGER INPUT**). The external trigger must be a signal between -5 and +5 volts.

Ext Rear - Activates the rear panel external trigger input (**TRIGGER IN**). The external trigger must be a signal between -5 and +5 volts.

Frame - Uses the internal frame clock to generate a trigger signal. The clock parameters are controlled under the **Mode Setup** key or the measurement firmware, but not both. See the specific measurement for details.

Line - Activates an internal line trigger. Sweep triggers occur at intervals synchronized to the line frequency.

NOTE

Rear panel **TRIGGER 1 OUT** and **TRIGGER 2 OUT** connectors are coupled to the selected trigger source. These trigger outputs are always on the rising edge with a pulse width of at least 1 μ s.

- **Burst Sync** - Pressing the **Burst Sync** key allows you to choose the source used to synchronize the measurement to the “T0” point of the GSM or EDGE burst. The “T0” point is defined as the time point of the transition from bit 13 to bit 14 of the midamble training sequence for a given time slot. The **Burst Search Threshold** setting (in the **Mode Setup** keys under **Trigger**) applies to both **Training Seq** and **RF Amptd**.

Training Seq - Synchronizes the measurement to the timing of the demodulated training sequence in the GSM burst. This is the most precise method, but requires a GMSK or EDGE burst with a valid TSC (Training Sequence Code). The “T0” point is determined by demodulation of the burst and successful identification of the TSC. “T0” is then found to within 1/10 bit.

RF Amptd - Synchronizes the measurement to the burst transition of the measured RF carrier. “T0” is set to the 50% point between the start and end of the burst.

- **Trace Data ON/OFF** - When Trace Data is set to On, I/Q trace data are shown as well as Phase and Frequency error trace data, but the measurement takes a little longer. Turn Trace Data Off to improve measurement speed.
- **I/Q Origin Offset Meas ON/OFF** - When I/Q Origin Offset Meas set to On, the measurement is performed and the result shown.

Table 3-6

Phase and Frequency Error Measurement Defaults

| Measurement Parameter | Factory Default Condition |
|-----------------------|---------------------------|
| Avg Bursts | 10 Off |
| Avg Mode | Repeat |
| Avg Type | Maximum |
| Limits | |
| RMS Phase Error | 5 deg |
| Peak Phase Error | 20 deg |
| Freq Error | |
| Base, Normal, Micro | 0.05 ppm |
| Base, Pico | 0.1 ppm |
| Base, Mobile | 0.1 ppm |
| Trig Source | RF Burst (Wideband) |
| Burst Sync | Training Sequence |

Table 3-6**Phase and Frequency Error Measurement Defaults**

| Measurement Parameter | Factory Default Condition |
|------------------------------|----------------------------------|
| Trace Data | On |
| I/Q Origin Offset Meas | On |

Trace/View Key Menu

Key Path: **Trace/View**

The **Trace/View** key allows you to select the desired view of the measurement from the following:

- **I/Q Error (Quad-View)** - Provides a combination view including
 - Window 1: Phase Error
 - Window 2: Phase Error with Freq
 - Window 3: RF Envelope
 - Window 4: Numeric Results, including Trigger to T0 measurement, and demodulated bits

Figure 3-19 GMSK Phase and Frequency Error Result - I/Q Error (Quad View)

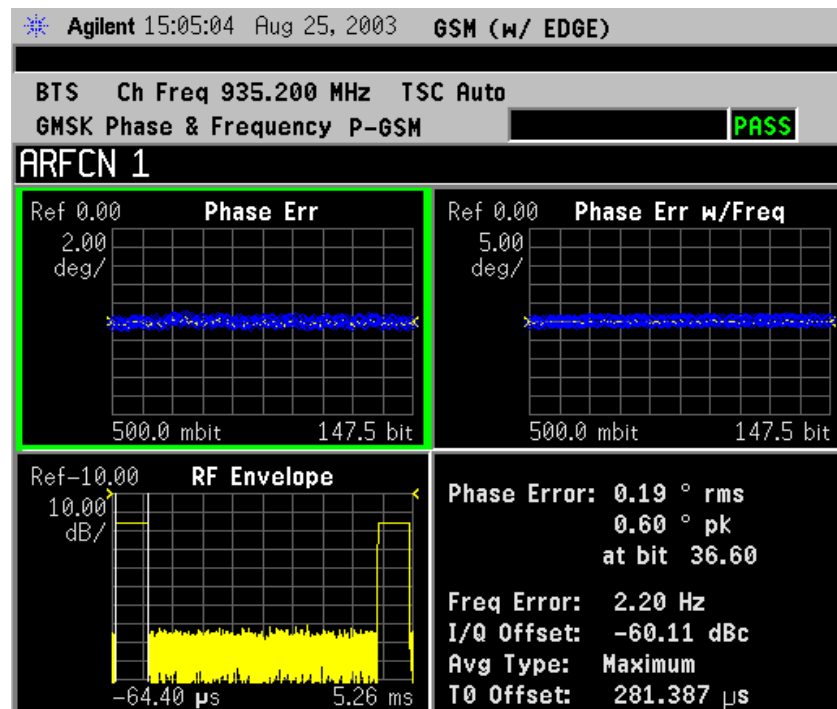

NOTE

Any of these windows can be selected (using the **Next Window** key) and made full size (using the **Zoom** key).

Key Reference
Measurement Keys

- **I/Q Measured Polar Vector** - Provides a view of numeric results and a polar vector graph.

Window 1: Numeric Results

Window 2: Polar Vector Graph

Figure 3-20 GSMK Phase and Frequency Error Result - Polar Vector View

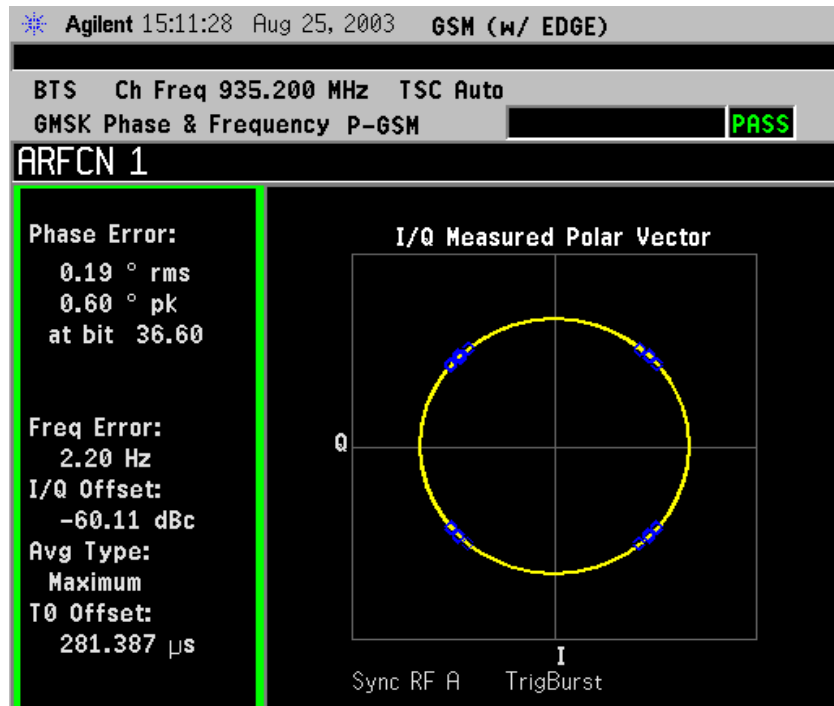

- **Data Bits** - Provides a view of the numeric results and data bits with the sync word (TSC) highlighted.

Figure 3-21 GMSK Phase and Frequency Error Result - Data Bits

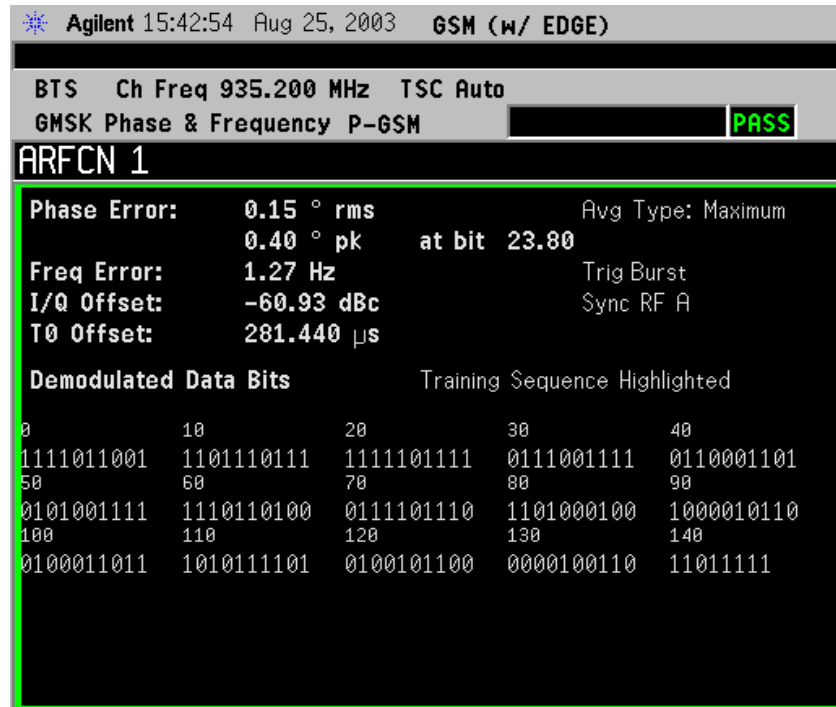

NOTE

The menus under the **SPAN X Scale** and **AMPLITUDE Y Scale** keys are context dependent upon the selected window (graph type). The **SPAN X Scale** parameters have units of time or bits, dependent on the view selected. The **AMPLITUDE Y Scale** parameters have units of dB or degrees, dependent on the view selected. All of the softkey labels are blank when **I/Q Measured Polar Vector**, or **Data Bits** are selected.

Display Menu Keys

Key Path: **Display**

The **Display** key allows you to turn the bit dots on and off.

GMSK Power vs. Time Measurement Keys

NOTE Make sure the **GMSK Pwr vs Time** measurement is selected under the **MEASURE** menu.

Meas Setup Key Menu

Key Path: **Meas Setup**

- **Avg Bursts On/Off** - Allows you to select whether averages are made or not, and allows you to change the number of N averages that are made.
- **Avg Mode Exp Repeat** - Allows you to choose either exponential or repeat averaging. This selection only effects the averaging after the number of N averages is reached (set using the **Averages**, **Avg Bursts**, or **Avg Number** key).

Normal averaging - Normal (linear) averaging is always used until the specified number of N averages is reached. When **Measure** is set at **Single**, data acquisitions are stopped when the number of averages is reached - thus **Avg Mode** has no effect on single measurements.

Exponential averaging - When **Measure** is set at **Cont**, data acquisitions continue indefinitely. After N averages, exponential averaging is used with a weighting factor of N (the displayed average count stops at N). Exponential averaging weights new data more than old data, which allows tracking of slow-changing signals. The weighting factor N is set using the **Averages**, **Avg Bursts**, or **Avg Number** key.

Repeat averaging - When **Measure** is set at **Cont**, data acquisitions continue indefinitely. After N averages is reached, all previous result data is cleared and the average count is set back to 1. This is equivalent to being in **Measure Single** and pressing the **Restart** key when the Single measurement finishes.

- **Avg Type** - Select the averaging type from the following selections: (Not all of the selections are available for all measurements)

Pwr Avg (RMS) - True power averaging that is equivalent to taking the RMS value of the voltage. It is the most accurate type of averaging.

Log-Pwr Avg (Video) - Simulates the traditional spectrum analyzer type of averaging by averaging the log of the power.

Mean - Averages the mean values.

Voltage Avg - Averages the voltage values.

Maximum - Keeps track of the maximum values.

Minimum - Keeps track of the minimum values.

Max & Min - Keeps track of the maximum and minimum values.

- **Meas Time** - Allows you to measure more than one timeslot. Enter a value in integer increments of “slots” with a range of 1 to 8. The actual measure time in μs is set somewhat longer than the specified number of slots in order to view the complete burst.
- **Trig Source Key Menu**

Changing the selection in the **Trig Source** menu alters the trigger source for the selected measurement only. Not all of the selections are available for all measurements. Note that the **RF Burst (Wideband)**, **Video (IF Envlp)**, **Ext Front**, and **Ext Rear** menu keys found in the **Trigger** menu enable you to change settings to modify the delay, level, and slope for each of these trigger sources.

Free Run (Immediate) - The trigger occurs at the time the data is requested, completely asynchronous to the RF or IF signal.

RF Burst (Wideband) - An internal wideband RF burst trigger that has an automatic level control for burst signals. It triggers on a level that is relative to the peak of the signal passed by the RF. If the data sent is all 0 bits, this trigger will give erratic or falsely high EVM results.

Video (IF Envlp) - An internal IF envelope trigger. It triggers on an absolute threshold level of the signal passed by the IF.

Ext Front - Activates the front panel external trigger input (**EXT TRIGGER INPUT**). The external trigger must be a signal between -5 and $+5$ volts.

Ext Rear - Activates the rear panel external trigger input (**TRIGGER IN**). The external trigger must be a signal between -5 and $+5$ volts.

Frame - Uses the internal frame clock to generate a trigger signal. The clock parameters are controlled under the **Mode Setup** key or the measurement firmware, but not both. See the specific measurement for details.

Line - Activates an internal line trigger. Sweep triggers occur at intervals synchronized to the line frequency.

Rear panel **TRIGGER 1 OUT** and **TRIGGER 2 OUT** connectors are coupled to the selected trigger source. These trigger outputs are always on the rising edge with a pulse width of at least 1 μ s.

- **Burst Sync Key Menu**

Pressing the **Burst Sync** key allows you to choose the source used to synchronize the measurement to the “T0” point of the GSM or EDGE burst. The “T0” point is defined as the time point of the transition from bit 13 to bit 14 of the midamble training sequence for a given time slot. The **Burst Search Threshold** setting (in the **Mode Setup** keys under **Trigger**) applies to both **Training Seq** and **RF Amptd**. Pressing the **Burst Sync** key brings up a menu with some or all of the following choices:

Training Seq - Synchronizes the measurement to the timing of the demodulated training sequence in the GSM burst. This is the most precise method, but requires a GMSK or EDGE burst with a valid TSC (Training Sequence Code). The “T0” point is determined by demodulation of the burst and successful identification of the TSC. “T0” is then found to within 1/10 bit.

RF Amptd - Synchronizes the measurement to the burst transition of the measured RF carrier. “T0” is set to the 50% point between the start and end of the burst.

None - The start of the time record is the start of the measured data. Set **Trigger Delay** as needed to capture the data to be measured.

- **Pwr Cntrl Lvl** - Used to indicate the output power of the transmitter; in MS testing transmitter output power variations affects the mask (in BTS testing the mask is unaffected). The appropriate power level for measuring the device under test corresponds with the transmitter power control level setting. This key is only available if **Limit Mask** is set to **Standard**.
- **Advanced** - Accesses a menu to change the following parameters:

NOTE

Parameters that are under the Advanced key seldom need to be changed. Any changes from the default values may result in invalid measurement data.

RBW Filter - Chooses the type of filter, either **Gaussian** or **Flat** (Flatop). Gaussian is the best choice when looking at the overall burst or the rising and falling edges, as it has excellent pulse response. If you want to precisely examine just the useful part of the burst, choose **Flat**.

Res BW - Sets the resolution bandwidth.

Timeslot Length - Timeslot configurations can appear in two forms.

When making Multi-slot measurements, select a type of timeslot length configuration from the following list:

All 156.25 symb - A uniform limit mask of 156.25 symbols in length is applied to all slots.

157/156 symb - A limit mask of 157 symbols in length is applied to slots 0 and 4, while a limit mask of 156 symbols in length is applied to slots 1, 2, 3, 5, 6 and 7.

Table 3-7

Power vs. Time Measurement Defaults

| Measurement Parameter | Factory Default Condition |
|-----------------------|---------------------------|
| Avg Bursts | 10 Off |
| Avg Mode | Exp |
| Avg Type | Pwr Avg (RMS) |
| Meas Time | 1 Slot |
| Timeslot | 0 Off |
| Trig Source | RF Burst (Wideband) |
| Burst Sync | Training Seq |
| Advanced | |
| RBW Filter | Gaussian |
| Res BW | 500.000 kHz |

Trace/View Menu Keys

Key Path: **Trace/View**

The **Trace/View** key accesses a menu that allows you to select the desired view of the measurement from the following selections:

- **Burst** - Select Burst View, which views the entire burst of interest as determined by the current trigger source, burst sync, training sequence, and timeslot settings. To view a different burst of interest you must set these parameters for the selected timeslot. To view multiple slots use the **Multi-Slot** key described below. See [Figure 3-22](#), “GMSK Power vs. Time Result - Burst View,” below.

Figure 3-22 GMSK Power vs. Time Result - Burst View

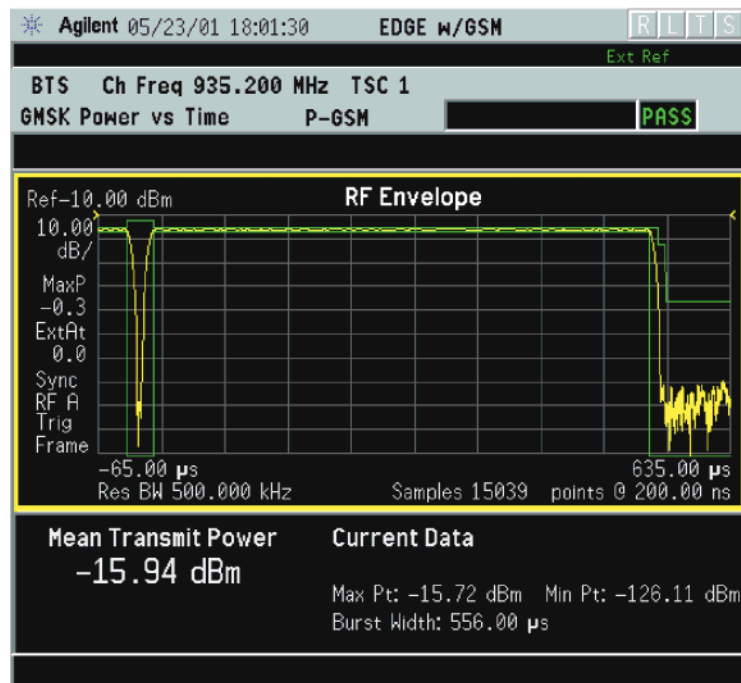

NOTE

When **Rise & Fall** is selected, the limit test is still performed on the entire burst (viewed using the **Burst** menu).

Information shown in the left margin of the displays include:

MaxP - This is total input power allowed for the measurement. This value is coupled to the internal RF **Input Atten** setting.

ExtAt - This value reflects the **External RF Atten** setting.

Sync - The **Burst Sync** setting used in the current measurement

Trig - The **Trigger Source** setting used in the current measurement

- **Rise & Fall** - Select Rise & Fall View, which zooms in on the rising and falling portions of the burst being tested.

Figure 3-23 GMSK Power vs. Time Result - Rise & Fall View

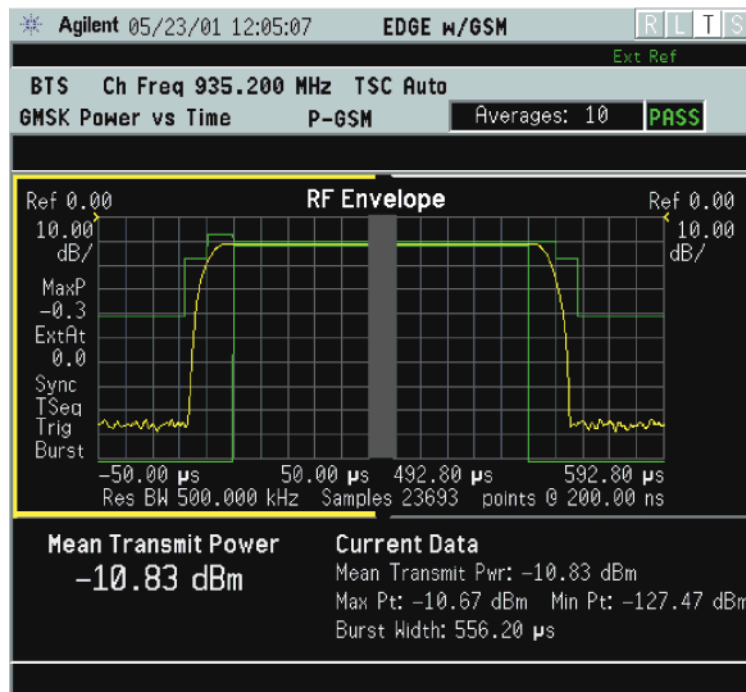

The **Mean Transmit Power** is displayed at the bottom left of the Burst and Rise & Fall views:

Mean Transmit Power - This is the RMS average power across the “useful” part of the burst, or the 147 bits centered on the transition from bit 13 to bit 14 (the “T0” time point) of the 26 bit training sequence. An RMS calculation is performed and displayed regardless of the averaging mode selected for the trace data.

NOTE

If Averaging = ON, the result displayed is the RMS average power of all bursts measured. If Averaging = OFF, the result is the RMS average power of the single burst measured. This is a different measurement result from Mean Transmit Pwr, below.

The **Current Data** displayed at the bottom of the Burst and Rise & Fall views include:

Mean Transmit Pwr - This result appears only if Averaging = ON. It is the RMS average of power across the “useful” part of the burst, for the current burst only. If a single measurement of “n” averages has been completed, the result indicates the Mean Transmit Pwr of the last burst. The RMS calculation is performed and displayed regardless of the averaging mode selected for the trace data. This is a different measurement result from Mean Transmit Power, above.

Max Pt. - Maximum signal power point in dBm

Min Pt. - Minimum signal power point in dBm

Burst Width - Time duration of burst at -3 dB power point (half-power)

Mask Ref Pwr Midamble - The Mask Reference Power is the average power in dBm of the middle 16 symbols in the midamble. The times displayed are the corresponding start and stop times of the middle 16 symbols.

1st Error Pt - (Error Point) The time (displayed in ms or μ s) indicates the point on the X Scale where the first failure of a signal was detected. Use a marker to locate this point, in order to examine the nature of the failure.

- **Multi-Slot** - Select Multi-Slot View, which views the entire sweep as specified by the current **Meas Time** setting. Power levels for each active slot are listed in a table below the timeslot display. Also shown in the table, under **1st Error Pt.**, is the point in time at which the signal level first exceeds the limit, which helps to identify the slot where a failure first occurs.

Figure 3-24 GPRS Power vs. Time Result - Multi-Slot View (2 slots shown)

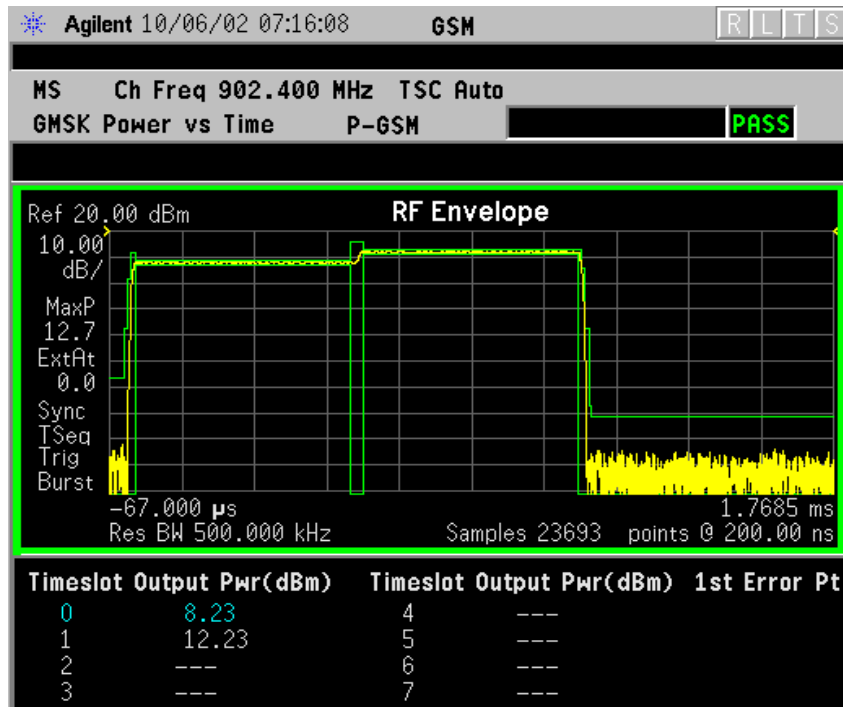
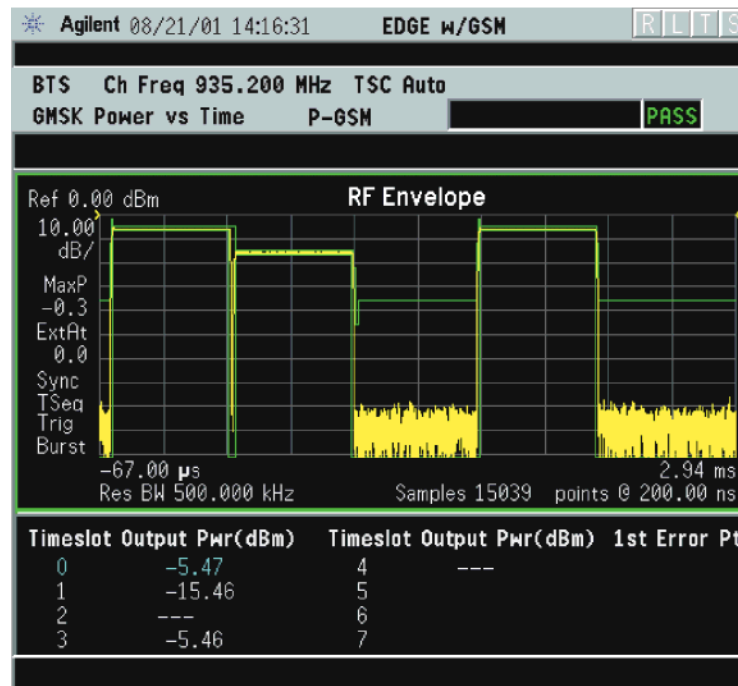

Figure 3-25 GSMK Power vs. Time Result - Multi-Slot View (5 slots shown)

The table in the lower portion of the multi-slot view shows the output power in dBm for each timeslot, as determined by the integer (1 to 8) entered in the **Meas Setup, Meas Time** setting. Output power levels are presented for the active slots; a dashed line appears for any slot that is inactive. The timeslot that contains the burst of interest is highlighted in blue.

Use the **Meas Time** key located in the **Meas Setup** menu to select up to eight slots. Use the **Timeslot** and **TSC** keys in the **Frequency/Channel** menu to select the slot you wish to activate. Setting **Timeslot** to **ON** and selecting a specific slot results in activating a measurement of that slot only (**Timeslot On** can be used to isolate a failure to a specific slot). When **Timeslot** is set to **OFF**, all active slots are tested against the mask.

Using a signal generator you can synchronize the multi-slot view so the frame (or portion of the frame) you are viewing starts with the slot you have selected. See [“GSMK Power vs. Time Measurement Concepts” on page 527](#).

You can switch from the multi-slot view directly to the burst or rise and fall views of the slot that is currently active. The **Scale/Div** key under the **Span/Y Scale** menu can be used to enlarge your view of this signal.

Display Menu Keys

Key Path: **Display**

- **Limit Mask ON/OFF** - The **Display** key allows you to turn the limit mask on and off. This also disables the mask limit test, but still calculates the power in the useful part.

GMSK Tx Band Spur Measurement Keys

NOTE Make sure the **Tx Band Spur** measurement is selected under the **MEASURE** menu.

Meas Setup Key Menu

Key Path: **Meas Setup**

- **Averages, Avg Bursts On Off** and **Avg Number** - Allow you to change the number of N averages that are made. **Avg Number** - Also allows you to select whether averages are made or not.
- **Avg Mode Exp Repeat** - Allows you to choose either exponential or repeat averaging. This selection only effects the averaging after the number of N averages is reached (set using the **Averages, Avg Bursts, or Avg Number** key).

Normal averaging - Normal (linear) averaging is always used until the specified number of N averages is reached. When **Measure** is set at **Single**, data acquisitions are stopped when the number of averages is reached - thus **Avg Mode** has no effect on single measurements.

Exponential averaging - When **Measure** is set at **Cont**, data acquisitions continue indefinitely. After N averages, exponential averaging is used with a weighting factor of N (the displayed average count stops at N). Exponential averaging weights new data more than old data, which allows tracking of slow-changing signals. The weighting factor N is set using the **Averages, Avg Bursts, or Avg Number** key.

Repeat averaging - When **Measure** is set at **Cont**, data acquisitions continue indefinitely. After N averages is reached, all previous result data is cleared and the average count is set back to 1. This is equivalent to being in **Measure Single** and pressing the **Restart** key when the Single measurement finishes.

- **Avg Type** - Select the averaging type from the following selections: (Not all of the selections are available for all measurements)

Pwr Avg (RMS) - True power averaging that is equivalent to taking the RMS value of the voltage. It is the most accurate type of averaging.

Log-Pwr Avg (Video) - Simulates the traditional spectrum analyzer type of averaging by averaging the log of the power.

Mean - Averages the mean values.

Voltage Avg - Averages the voltage values.

Maximum - Keeps track of the maximum values.

Minimum - Keeps track of the minimum values.

Max & Min - Keeps track of the maximum and minimum values.

- **Meas Type** - Select the measurement type from the following selections:

Full - In Continuous Measure, it repeatedly does full search of all segments.

Examine- In Continuous Measure, after doing one full search across all segments, it parks on the worst segment and continuously updates that segment.

- **Limit** - Set the absolute or relative limit. The limit range is from -200 dBm to 100 dBm.

dBm - Absolute limit.

dBc - Relative to Mean Transmit Power.

Table 3-8

Tx Band Spur Measurement Defaults

| Measurement Parameter | Factory Default Condition |
|-----------------------|---------------------------|
| Avg Number | 30 On |
| Avg Mode | Repeat |
| Avg Type | Maximum |
| Meas Type | Full |
| Limit | -36 dBm |

Trace/View Menu Keys

Key Path: **Trace/View**

The **Trace/View** key allows you to further examine the desired spectrum segment. Each of these choices selects a different part of the frequency spectrum for viewing:

- **Lower Segment** - Select lower Tx band edge to -6 MHz offset from the channel frequency for display.
- **Lower Adj Segment** - Select -6 MHz to -1.8 MHz offset from the channel frequency for display.
- **Upper Adj Segment** - Select +1.8 MHz to +6 MHz offset from the channel frequency for display.
- **Upper Segment** - +6 MHz offset from the channel frequency to the upper Tx band edge for display.

Figure 3-26 EDGE Tx Band Spur Result - Upper Adj Segment

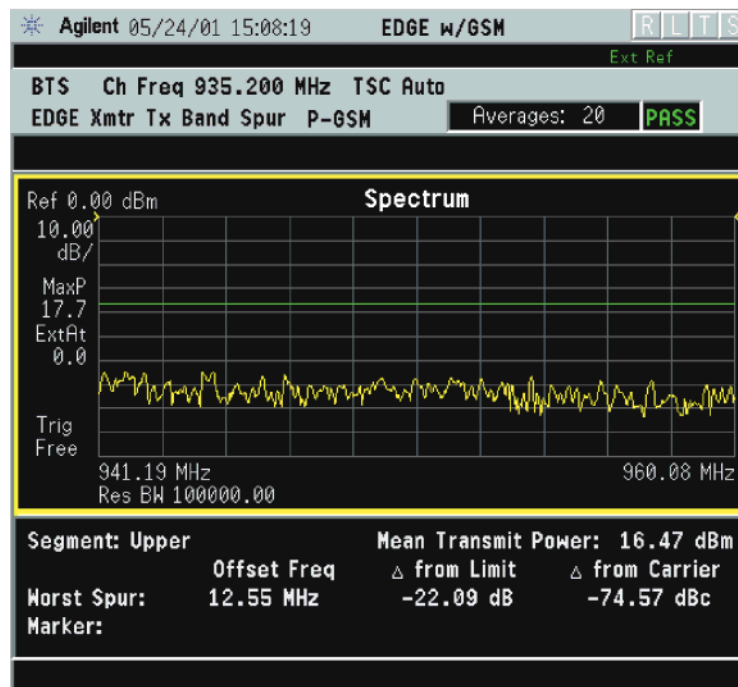

Spectrum (Frequency Domain) Keys

NOTE You must have selected **Spectrum** under the **MEASURE** menu to access these menus

Meas Setup Key Menu

Key Path: **Meas Setup**

- **Span** - Modifies the frequency span. The range is 10 Hz to 10 MHz with 1 Hz resolution, depending on the **Res BW** setting. Changing the span causes the resolution bandwidth to change automatically, and affects data acquisition time.
- **Res BW** - Sets the resolution bandwidth for the FFT, and to toggle its mode between **Auto** and **Man** (manual). If set to **Auto**, the resolution bandwidth is set to **Span/50** (2% of the span). If set to **Man**, you can enter a value ranging from 100.0 mHz to 3.00000 MHz. A narrower bandwidth results in a longer data acquisition time.
- **Average**

Avg Number - Changes the number of N averages.

Avg Mode - Toggles the averaging mode between **Exp** (exponential) and **Repeat**. This selection only effects on the averaging result after the number of N averages is reached. The N is set using the **Avg Number** key.

Normal averaging - Normal (linear) averaging is always used until the specified number of N averages is reached. When the **Measure** key under **Meas Control** is set to **Single**, data acquisition is stopped when the number of N averages is reached, thus **Avg Mode** has no effect in the single measurement mode.

Exponential averaging - When **Measure** is set to **Cont**, data acquisition continues indefinitely. Exponential averaging is used with a weighting factor of N (the displayed count of averages stops at N). Exponential averaging weights new data more heavily than old data, which allows tracking of slow-changing signals. The weighting factor N is set using the **Avg Number** key.

Repeat averaging - When **Measure** is set to **Cont**, data acquisition continues indefinitely. After the number of N averages is reached, all previous result data is cleared and the average count displayed is set back to 1. This is equivalent to being in **Measure Single** and pressing the **Restart** key each time the single measurement finishes.

Avg Type - Accesses the menu of the following average types only for making spectrum (frequency domain) and waveform (time domain) measurements:

Pwr Avg (RMS) - Executes the true power averaging which is calculated by averaging the rms voltage. This is the most accurate type.

Log-Pwr Avg (Video) - Simulates the traditional spectrum analyzer type of averaging by calculating the log of the power. This type of averaging underestimates the power when the signal is noise-like.

Voltage Avg - Executes voltage averaging.

Maximum - Captures peak voltage data. Simulates the traditional spectrum analyzer peak hold function.

Minimum - Captures the minimum voltage data, similar to the maximum function.

- **Trig Source**

Key path: **Meas Setup, Trig Source**

NOTE

Changing the selection in the **Trig Source** menu alters the trigger source for the selected measurement only.

Free Run (Immediate) - A trigger occurs at the time the data is requested, completely asynchronous with the RF or IF signal.

Video (Envlp) - An internal IF envelope trigger that occurs at the absolute threshold level of the IF signal level.

RF Burst (Wideband) - An internal wideband RF burst trigger that has the automatic level control for burst signals. It triggers at the level that is set relative to the peak RF signal (12 MHz bandwidth) input level.

Ext Front - Activates the front panel external trigger input (**EXT TRIGGER INPUT**) port. The external signal must be between -5.00 and $+5.00$ V with 1 or 10 mV resolution.

Ext Rear - Activates the rear-panel external trigger input (**TRIGGER IN**) port. The external signal must be between -5.00 and $+5.00$ V with 1 or 10 mV resolution.

Frame - Uses the internal frame clock to generate a trigger signal. The clock parameters are controlled under the **Mode Setup** key or the measurement firmware, but not both. Refer to the specific measurement section for details.

Line - Sets the trigger to the internal line mode. Sweep triggers occur at intervals synchronous to the line frequency. See the specific measurement section for details.

- **Restore Meas Defaults** - Presets only the settings that are specific to the selected measurement by pressing **Meas Setup, More (1 of 2), Restore Meas Defaults** - Sets the measure setup parameters, for the currently selected measurement only, to the factory defaults.
- **(Narrowband) Advanced** - Accesses the menu to change the following parameters.

NOTE

The advanced features should be used only if you are familiar with their operation. Changes from the default values may result in invalid data.

The **Narrowband** key word is only present if you have Option B7J and either Option 122 or 140 installed. Parameters that are under the **(Narrowband) Advanced** key only affect the standard narrow band IF path. The wideband IF advanced functions are found under the **Wideband Advanced** key.

Pre-ADC BPF - Toggles the pre-ADC bandpass filter function between **On** and **Off**. The pre-ADC bandpass filter is useful for rejecting nearby signals, so that sensitivity within the span range can be improved by increasing the ADC range gain.

Pre-FFT Filtr - Toggles the pre-FFT filter between **Flat** (flat top) and **Gaussian**. The pre-FFT filter defaults to a flat top filter which has better amplitude accuracy. The Gaussian filter has better pulse response.

Pre-FFT BW - Toggles the pre-FFT bandwidth function between **Auto** and **Man** (manual). The pre-FFT bandwidth filter can be set between 1 Hz and 10 MHz. If set to **Auto**, this pre-FFT bandwidth is nominally 50% wider than the span. This bandwidth determines the ADC sampling rate.

FFT Window - Accesses the following selection menu. Unless you are familiar with FFT windows, use the flat top filter (the default filter).

Flat Top - Select this filter for best amplitude accuracy, by reducing scalloping error.

Uniform - Select this filter to have no filter window active.

Hanning - Activates the Hanning filter.

Hamming - Activates the Hamming filter.

Gaussian - Activates the Gaussian filter with the roll-off factor (alpha) of 3.5.

Blackman - Activates the Blackman filter.

Blackman Harris - Activates the Blackman Harris filter.

K-B 70dB/90dB/110dB (Kaiser-Bessel) - Select one of the Kaiser-Bessel filters with sidelobes at -70, -90, or -110 dBc.

FFT Size - Accesses the menu to change the following parameters:

Length Ctrl - Toggles the FFT and window length setting function between **Auto** and **Man** (manual).

Min Pts in RBW - Sets the minimum number of data points that are used inside the resolution bandwidth. The range is 0.10 to 100.00 points with 0.01 resolution. This key is grayed out if **Length Ctrl** is set to **Man**.

Window Length - Enters the FFT window length, as a number of capture samples, ranging from 8 to 1048576. This length represents the actual quantity of I/Q samples that are captured for processing by the FFT (“Capture Time” is the associated parameter shown on the screen). This key is grayed out if **Length Control** is set to **Auto**.

FFT Length - Enters the FFT length, as a number of captured samples, ranging from 8 to 1048576. The FFT length setting is automatically limited so that it is equal to or greater than the FFT window length setting. Any amount greater than the window length is implemented by zero-padding. This key is grayed out if **Length Control** is set to **Auto**.

ADC Range - Accesses the menu to define one of the following ADC ranging functions:

Auto - Sets the ADC range automatically. For most FFT spectrum measurements, the auto feature should not be selected. An exception is when measuring a signal which is “bursty”, in which case auto can maximize the time domain dynamic range, if FFT results are less important to you than time domain results.

Auto Peak - Sets the ADC range automatically to the peak signal level. Auto peak is a compromise that works well for both CW and burst signals.

Auto Peak Lock - Select this to hold the ADC range automatically at the peak signal level. Auto peak lock is more stable than auto peak for CW signals, but should not be used for “bursty” signals.

Manual - Accesses the selection menu of values, -6 to +24 dB for E4406A or None to +18 dB for PSA, to set the ADC range level. Also note that manual ranging is best for CW signals.

Data Packing - Selects **Auto** (the default) or the **Short (16 bit)**, **Medium (24 bit)** and **Long (32 bit)** methods of data packing. The short, medium, and long methods are not compatible with all settings and should not be used unless you are familiar with data packing methods. **Auto** is the preferred choice.

Auto - The data packing value most appropriate for current

instrument settings is selected automatically.

Short (16 bit) - Select this to pack data every 16 bits.

Medium (24 bit) - Select this to pack data every 24 bits.

Long (32 bit) - Select this to pack data every 32 bits.

ADC Dither - Toggles the ADC dither function between **Auto**, **On**, and **Off**. When set to **Auto** (the default), the ADC dither function is activated when a narrow bandwidth is being measured, and deactivated when a wide bandwidth is being measured. “ADC dither” refers to the introduction of noise to the digitized steps of the analog-to-digital converter; the result is an improvement in amplitude accuracy. Use of the ADC dither, however, reduces dynamic range by approximately 3 dB.

Decimation - Toggles the decimation function between **Auto** and **Man**, and to set the decimation value. **Auto** is the preferred setting, and the only setting that guarantees alias-free FFT spectrum measurements. If you are familiar with the decimation feature, you can change the decimation value by setting to **Man**, but be aware that aliasing can occur at higher values. Decimation numbers 1 to 1000 describe the factor by which the number of points are reduced. The default setting is 0, which results in no data point reduction. Decimation by 3 keeps every 3rd sample, throwing away the 2 in between.

IF Flatness - Toggles the IF flatness function between **On** and **Off**. If set to **On** (the default), the IF flatness feature causes background amplitude corrections to be performed on the FFT spectrum. The **Off** setting is used for adjustment and troubleshooting of the test instrument.

The following table shows the factory default settings for spectrum (frequency domain) measurements.

Table 3-9

Spectrum (Frequency Domain) Measurement Defaults

| Measurement Parameter | Factory Default Condition |
|--------------------------------|---------------------------|
| Trace Display | All |
| Res BW | 20.0000 kHz; Auto |
| Averaging: | |
| Avg Number | 25; On |
| Avg Mode | Exp |
| Avg Type | Log-Pwr Avg (Video) |
| Time Avg Num (Opt. 122 or 140) | 1 |
| Trig Source | RF Burst (Wideband) |
| Region/Limits: | |

Table 3-9 Spectrum (Frequency Domain) Measurement Defaults

| Measurement Parameter | Factory Default Condition |
|---|-----------------------------------|
| Region | A |
| Upper Mask | A: -40.00 dB; On |
| Lower Mask | A: -100.00 dB; Off |
| Offset Start | A: -667.0 μ s |
| Offset Stop | A: -25.0 μ s |
| Interval | A: 642.0 μ s |
| IF Path (requires Option B7J and Option 122 or 140) | Narrow |
| Wideband IF Gain (Opt. 122 or 140) | 0.00 dB |
| Wideband Filtering (Opt. 122 or 140) | None |
| Filter Type | 0.30 |
| Filter Alpha | 0.50 |
| Filter BW | |
| Spectrum View: | |
| SPAN | 1.000 MHz (VSA), 10.000 MHz (PSA) |
| AMPLITUDE Y Scale - Scale/Div | 10.00 dB |
| I/Q Waveform View: | |
| Capture Time | 188.00 μ s |
| AMPLITUDE Y Scale - Scale/Div | 100.0 mV |
| (Narrowband) Advanced | |
| Pre-ADC BPF | On |
| Pre-FFT Filter | Flat |
| Pre-FFT BW | 1.55000 MHz; Auto |
| FFT Window | Flat Top (High Amptd Acc) |
| FFT Size: | |
| Length Control | Auto |
| Min Points/RBW | 3.100000 |
| Window Length | 706 (VSA), 566 (PSA) |
| FFT Length | 1024 |
| ADC Range | Auto Peak |
| Data Packing | Auto |
| ADC Dither | Auto |
| Decimation | 0; Auto |
| IF Flatness | On |

View/Trace Key Menu

The View/Trace key allows you to select the desired view of the measurement from the following. You can use the Next Window key to move between the multiple windows (if any) and make it full size by Zoom.

- **Spectrum** - Provides a combination view of the spectrum graph in parameters of power versus frequency with semi-log graticules, and the I/Q waveform graph in parameters of voltage and time. Changes to frequency span or power sometimes affect data acquisition. This is equivalent to changing the selected window with the **Next** key.

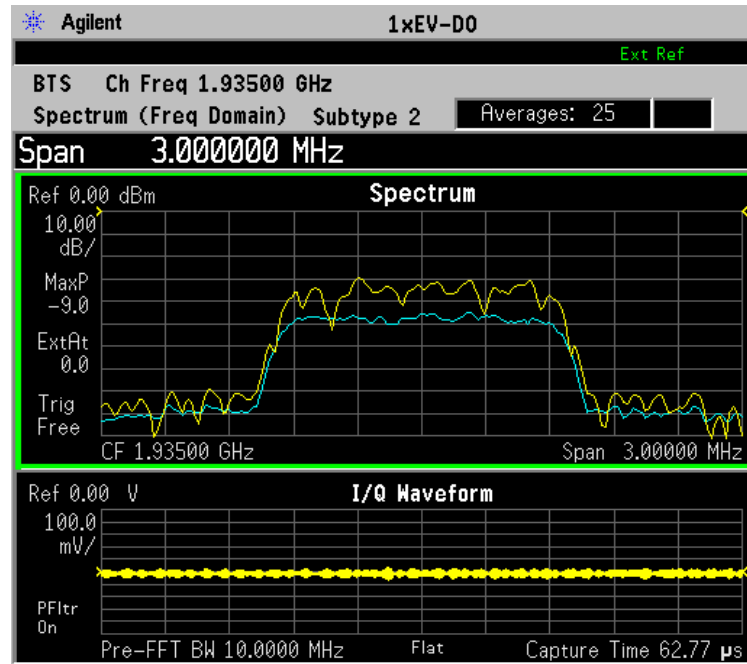
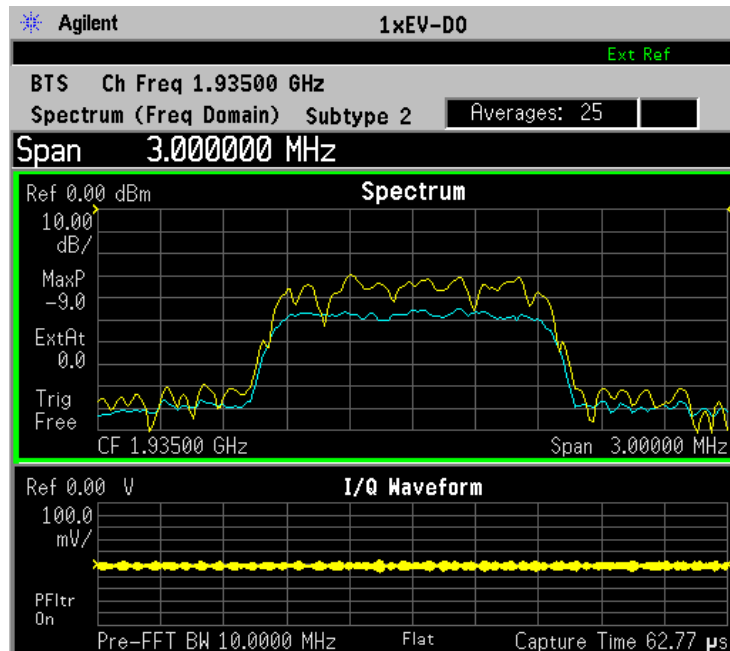
Figure 3-27 Spectrum Measurement - Spectrum and I/Q Waveform (Default View)**Figure 3-28** Spectrum Measurement - Spectrum and I/Q Waveform (Default View)

The spectrum measurement result should look like the above figure. The measurement result values are shown in the summary result window.

- **Spectrum (Time Domain) I/Q Waveform** - (Key for PSA only) This graph is shown below the **Spectrum** graph in the default dual-window display. **I/Q Waveform** provides a view of the I/Q waveform in parameters of voltage versus time in linear scale. Changes to sweep time or resolution bandwidth can affect data acquisition. Pressing this button is equivalent to pressing the **Next Window** button on the front panel. Press the **Zoom** key to view this display full-screen.

Key Reference
Measurement Keys

- **Spectrum Linear** - (for E4406A) Provides a view of the spectrum graph in parameters of voltage versus frequency in linear scale. Changes to frequency span or voltage can affect data acquisition.

Figure 3-29 Spectrum Measurement - Linear Spectrum View (for E4406A)

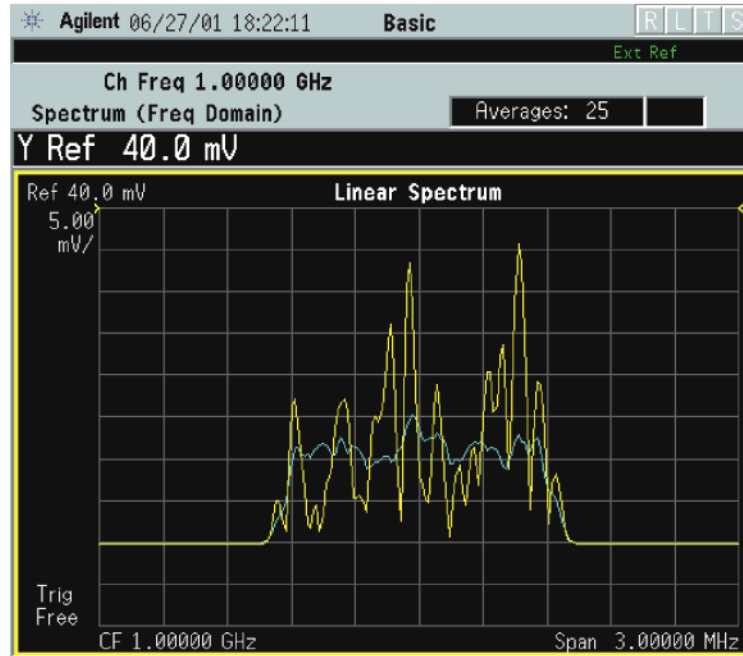
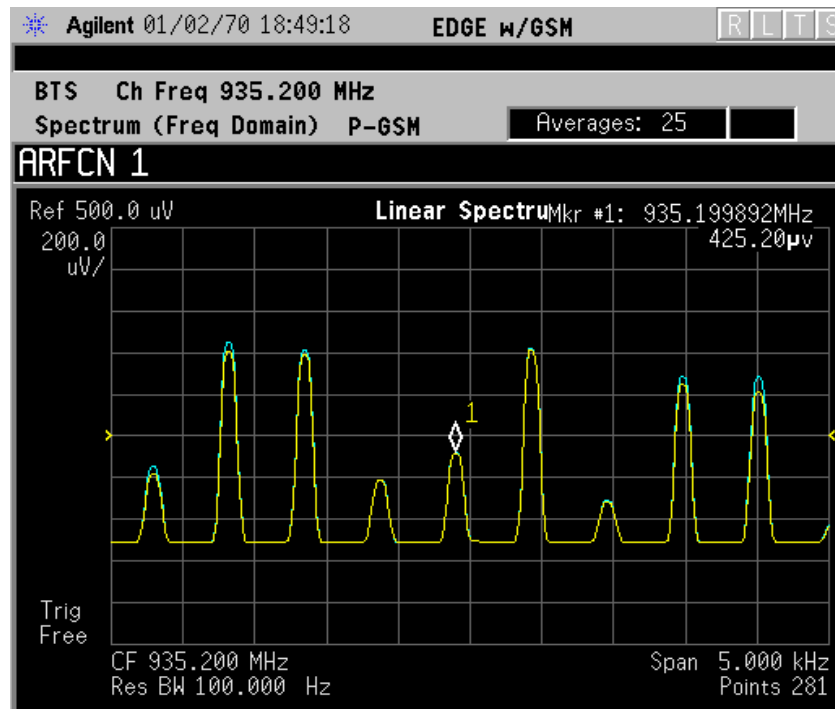

Figure 3-30 Spectrum Measurement - Linear Spectrum View (for E4406A)



*Meas Setup: View/Trace = Spectrum Linear,

Span = 5.000 kHz,
Y Scale/Div = 200 μ V, Ref Value = 500.0 μ V,
Others = Factory default settings

*Input signals: -20.00 dBm, EDGE pattern data (PN9)

*Meas Setup: View/Trace = Spectrum Linear,
Span = 3.000 MHz,
Y Scale/Div = 5.00 mV, Ref Value = 30.0 mV,
Others = Factory default settings

*Input signals: -10.00 dBm, 9 channels of SR1, cdma2000 Rev 8

NOTE

(for E4406A) For the widest spans, the I/Q window becomes just “ADC time domain samples”, because the I/Q down-conversion is no longer in effect. This is not the case for E4406A Option B7C if the **Input Port** is set to either **I/Q**, **I only**, or **Q only** and you have connected baseband I/Q signals to the **I/Q INPUT** connectors.

- **I and Q Waveform** - (for E4406A) Provides individual views of the I and Q signal waveform windows in parameters of voltage versus time.

To select the I or Q trace view, press the **Next** key at the bottom of the display. The selected window will have a green outline. To view the window full size press the **Zoom** key.

Figure 3-31 Spectrum Measurement - I and Q Waveform View (for E4406A)

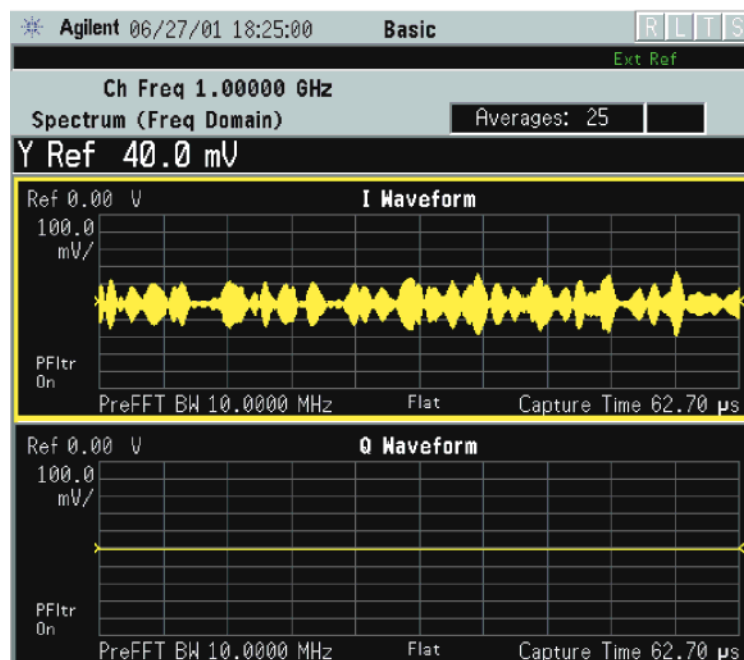
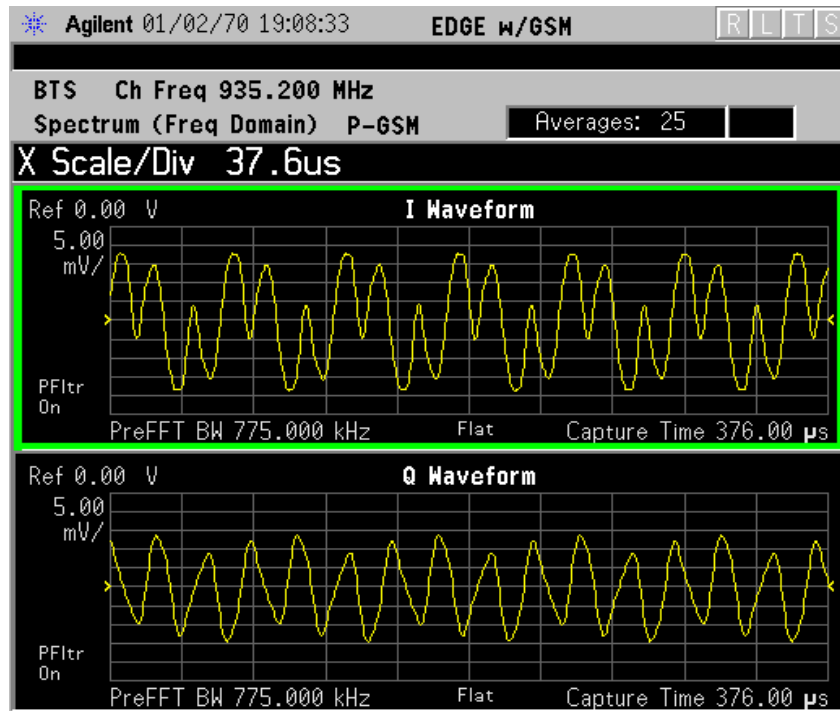

Figure 3-32 Spectrum Measurement - I and Q Waveform View (for E4406A)



*Meas Setup: View/Trace = I and Q Waveform
Span = 500.000 kHz,
Y Scale/Div = 5.0 mV, Ref Value = 0.0 V,
Others = Factory default settings

*Input signals: -20.00 dBm, EDGE pattern data (PN9)

- **I/Q Polar** - (for E4406A) Provides a view of the I/Q signal displayed in a polar vector graph.

Figure 3-33 Spectrum Measurement - I/Q Polar View (for E4406A)

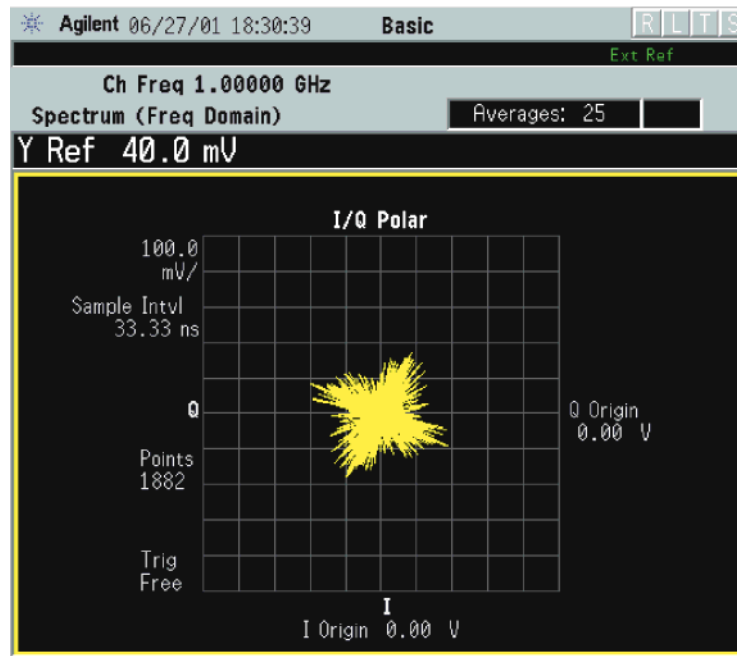

*Meas Setup: View/Trace = I/Q Polar,
Others = Factory default settings

*Input signals: -10.00 dBm, Pilot channel, 1xEV-DO

Figure 3-34 Spectrum Measurement - I/Q Polar View (for E4406A)

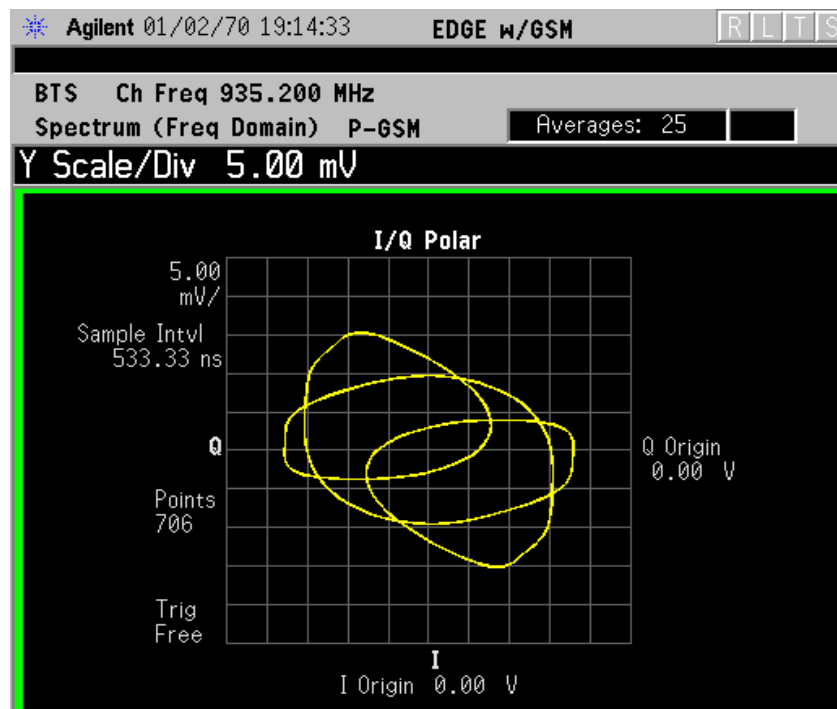

*Meas Setup: View/Trace = I/Q Polar

Key Reference
Measurement Keys

Span = 500.000 kHz,
Y Scale/Div = 5.0 mV, Ref Value = 0.0 V,
Others = Factory default settings

*Input signals: -20.00 dBm, EDGE pattern data (PN9)

- **Trace Display** - Press this key to reveal the trace selection menu. The currently selected trace type is shown on the **Trace Display** key.

All - Displays both the current trace and the average trace.

Average - Displays only the average trace (in blue color). See the **Meas Setup**, **Average** keys to select different types of averaging.

Current - Displays only the trace (in yellow color) for the latest data acquisition.

I Trace - (for E4406A) Views only the I signal trace.

Q Trace - (for E4406A) Views only the Q signal trace.

SPAN X Scale Key Menu

NOTE

The Spectrum or Linear Spectrum (for E4406A) window must be active in the **Spectrum** or **Spectrum Linear** (for E4406A) view to access the following **SPAN X Scale** key menu:

- **Span** - Modifies the frequency span. The range is 10.000 Hz to 10.000 MHz with 1 Hz resolution, depending on the **Res BW** setting. Changing the span causes the resolution bandwidth to change automatically, and affects data acquisition time. The **Span** key is also accessible under the **Meas Setup** menu.

NOTE

The I/Q Waveform (for E4406A) window must be active in the **Spectrum** or **Spectrum Linear** (for E4406A) view to access the following **SPAN X Scale** key menu:

- **Scale/Div** - Sets the horizontal scale by changing a time value per division. The range is 1.00 ns to 1.00 s per division. The default setting is 18.8 ms per division. However, since the **Scale Coupling** default is **On**, this value is automatically determined by the measurement results. When you set a value manually, **Scale Coupling** automatically changes to **Off**.
- **Ref Value** - Sets the reference value ranging from -1.00 to 10.0 s. The default setting is 0.00 s. However, since the **Scale Coupling** default is **On**, this value is automatically determined by the measurement results. When you set a value manually, **Scale Coupling** automatically changes to **Off**.
- **Ref Position** - Sets the reference position to either **Left**, **Ctr** (center) or **Right**. The default setting is **Left**.

- **Scale Coupling** - Toggles the scale coupling function between **On** and **Off**. The default setting is **On**. Upon pressing the **Restart** front-panel key or **Restart** softkey under the **Meas Control** menu, this function automatically determines the scale per division and reference values based on the measurement results. When you set a value to either **Scale/Div** or **Ref Value** manually, **Scale Coupling** automatically changes to **Off**.

NOTE

The I/Q Polar window must be active in the **I/Q Polar** view (for E4406A), for the **SPAN X Scale** key to access the following menu:

- **I/Q Scale/Div** - Sets the vertical and horizontal scales by changing the value per division. The range is 1.00 nV to 20.00 V per division. The default setting is 100.0 mV.
- **I Origin** or **Q Origin** - Sets the reference value ranging from -250.00 to 250.00 V. The default setting is 0.00 V.

AMPLITUDE Y Scale Key Menu

NOTE

The Spectrumor Linear Spectrum (for E4406A) window must be active in the **Spectrumor Spectrum Linear** (for E4406A) view to access the following **AMPLITUDE Y Scale** key menu:

- **Scale/Div** - Sets the vertical scale by changing an amplitude value per division. The range is 0.10 dB to 20.00 dB per division. The default setting is 10.00 dB. However, since the **Scale Coupling** default is **On**, this value is automatically determined by the measurement results. When you set a value manually, **Scale Coupling** automatically changes to **Off**.
- **Ref Value** - Sets the reference value ranging from -250.00 to 250.00 dBm. The default setting is 0.00 dBm. However, since the **Scale Coupling** default is **On**, this value is automatically determined by the measurement results. When you set a value manually, **Scale Coupling** automatically changes to **Off**.
- **Ref Position** - Sets the reference position to either **Top**, **Ctr** (center) or **Bot** (bottom). The default setting is **Ctr**.
- **Scale Coupling** - Toggles the scale coupling function between **On** and **Off**. The default setting is **On**. Upon pressing the **Restart** front-panel key or **Restart** softkey under the **Meas Control** menu, this function automatically determines the scale per division and reference values based on the measurement results. When you set a value to either **Scale/Div** or **Ref Value** manually, **Scale Coupling** automatically changes to **Off**.

NOTE

The I or Q Waveform window must be active in the **I and Q Waveform** view (**for E4406A**) for the **AMPLITUDE Y Scale** key to access the

following menu:

- **Scale/Div** - Sets the vertical scale by changing the amplitude value per division. The range is 1.00 nV to 20.00 V per division. The default setting is 100.0 mV. However, since the **Scale Coupling** default is **On**, this value is automatically determined by the measurement results. When you set a value manually, **Scale Coupling** automatically changes to **Off**.
- **Ref Value** - Sets the reference value ranging from -250.00 to 250.00 V. The default setting is 0.00 V. However, since the **Scale Coupling** default is **On**, this value is automatically determined by the measurement results. When you set a value manually, **Scale Coupling** automatically changes to **Off**.
- **Ref Position** - Sets the reference position to either **Top**, **Ctr** (center) or **Bot** (bottom). The default setting is **Ctr**.
- **Scale Coupling** - Toggles the scale coupling function between **On** and **Off**. The default setting is **On**. The **Restart** front-panel key or **Restart** softkey under the **Meas Control** menu, this function automatically determines the scale per division and reference values by the measurement results. When you set a value to either **Scale/Div** or **Ref Value** manually, **Scale Coupling** automatically changes to **Off**.

NOTE

The I/Q Polar window must be active in the **I/Q Polar** view (for E4406A), for the **AMPLITUDE Y Scale** key to access the following menu:

- **I/Q Scale/Div** - Sets the vertical and horizontal scales by changing the value per division. The range is 1.00 nV to 20.00 V per division. The default setting is 100.0 mV.
- **I Origin** or **Q Origin** - Sets the reference value ranging from -250.00 to 250.00 V. The default setting is 0.00 V.

Display Key Menu

The Display Key is not active for this measurement.

Marker Key Menu

- **Select 1 2 3 4** - Activates up to four markers with the corresponding numbers, respectively. The selected number is underlined and its function is defined by pressing the **Function** key. The default is 1.
- **Normal** - Activates the selected marker to read the frequency and amplitude of the marker position on the spectrum trace. Marker position is controlled by the **RPG** knob.
- **Delta** - Reads the differences in frequency and amplitude between the selected marker and the next marker.
- **Function Off** - Selects marker function to be **Band Power**, **Noise**, or **Off**.

The default is **Off**. If set to **Band Power**, you need to select **Delta**.

- **Trace Spectrum** - Places the selected marker on the **Spectrum**, **Spectrum Avg Spectrum Linear** (for E4406A), **Spectrum Avg Linear** (for E4406A) **I Waveform** (for E4406A), or **Q Waveform** (for E4406A) or **I/Q Waveform** trace. The default is **Spectrum**.
- **Off** - Turns off the selected marker.
- **Shape Diamond** - Accesses the menu to define the selected marker shape to be **Diamond**, **Line**, **Square**, or **Cross**. The default shape is **Diamond**.
- **Marker All Off** - Turns off all of the markers.

Peak Search Key

The front panel Search key performs a peak search when pressed. A marker is automatically activated at the highest peak.

Transmit Power Measurement Keys

NOTE Make sure the Transmit Power measurement is selected under the **MEASURE** menu.

Measurement Setup Key Menu

Key Path: **Meas Setup**

- **Averages, Avg Bursts On Off** and **Avg Number** - Allow you to change the number of N averages that are made. **Avg Number** - Also allows you to select whether averages are made or not.
- **Avg Mode Exp Repeat** - Allows you to choose either exponential or repeat averaging. This selection only effects the averaging after the number of N averages is reached (set using the **Averages**, **Avg Bursts**, or **Avg Number** key).

Normal averaging - Normal (linear) averaging is always used until the specified number of N averages is reached. When **Measure** is set at **Single**, data acquisitions are stopped when the number of averages is reached, thus **Avg Mode** has no effect on single measurements.

Exponential averaging - When **Measure** is set at **Cont**, data acquisitions continue indefinitely. After N averages, exponential averaging is used with a weighting factor of N (the displayed average count stops at N). Exponential averaging assigns greater weight to new data than to old data, which allows tracking of slow-changing signals. The weighting factor N is set using the **Averages**, **Avg Bursts**, or **Avg Number** key.

Repeat averaging - When **Measure** is set at **Cont**, data acquisitions continue indefinitely. After N averages is reached, all previous result data is cleared and the average count is set back to 1. This is equivalent to being in **Measure Single** and pressing the **Restart** key when the Single measurement finishes.

- **Avg Type** - Select the averaging type from the following selections: (Not all of the selections are available for all measurements)

Pwr Avg (RMS) - True power averaging that is equivalent to taking the RMS value of the voltage. It is the most accurate type of averaging.

Log-Pwr Avg (Video) - Simulates the traditional spectrum analyzer type of averaging by averaging the log of the power.

Mean - Averages the mean values.

Voltage Avg - Averages the voltage values.

Maximum - Keeps track of the maximum values.

Minimum - Keeps track of the minimum values.

Max & Min - Keeps track of the maximum and minimum values.

- **Meas Time** - Allows you to measure more than one timeslot. Enter a value in integer increments of “slots” with a range of 1 to 8. The actual measure time in μs is set somewhat longer than the specified number of slots, in order to view the complete burst.
- **Trig Source Key Menu**

Changing the selection in the **Trig Source** menu alters the trigger source for the selected measurement only. Not all of the selections are available for all measurements. Note that the **RF Burst (Wideband)**, **Video (IF Envlp)**, **Ext Front**, and **Ext Rear** menu keys found in the **Trigger** menu enable you to change settings to modify the delay, level, and slope for each of these trigger sources. Choose one of the following sources:

Free Run (Immediate) - The trigger occurs at the time the data is requested, completely asynchronous to the RF or IF signal.

RF Burst (Wideband) - An internal wideband RF burst trigger that has an automatic level control for burst signals. It triggers on a level that is relative to the peak of the signal passed by the RF. If the data sent is all 0 bits, this trigger will give erratic or falsely high EVM results.

Video (IF Envlp) - An internal IF envelope trigger. It triggers on an absolute threshold level of the signal passed by the IF.

Ext Front - Activates the front panel external trigger input (**EXT TRIGGER INPUT**). The external trigger must be a signal between -5 and $+5$ volts.

Ext Rear - Activates the rear panel external trigger input (**TRIGGER IN**). The external trigger must be a signal between -5 and $+5$ volts.

Frame - Uses the internal frame clock to generate a trigger signal. The clock parameters are controlled under the **Mode Setup** key or the measurement firmware, but not both. See the specific measurement for details.

Line - Activates an internal line trigger. Sweep triggers occur at intervals synchronized to the line frequency.

Rear panel **TRIGGER 1 OUT** and **TRIGGER 2 OUT** connectors are coupled to the selected trigger source. These trigger outputs are always on the rising edge with a pulse width of at least 1 μ s.

- **Burst Sync**

Pressing the **Burst Sync** key allows you to choose the source used to synchronize the measurement to the “T0” point of the GSM or EDGE burst. The “T0” point is defined as the time point of the transition from bit 13 to bit 14 of the midamble training sequence for a given time slot. The

Burst Search Threshold setting (in the **Mode Setup** keys under **Trigger**) applies to both **Training Seq** and **RF Amptd**. Pressing the **Burst Sync** key brings up a menu with some or all of the following choices:

Training Seq - Synchronizes the measurement to the timing of the demodulated training sequence in the GSM burst. This is the most precise method, but requires a GMSK or EDGE burst with a valid TSC (Training Sequence Code). The “T0” point is determined by demodulation of the burst and successful identification of the TSC. “T0” is then found to within 1/10 bit.

RF Amptd - Synchronizes the measurement to the burst transition of the measured RF carrier. “T0” is set to the 50% point between the start and end of the burst.

None - Use the start of the time record as the start of the useful part. “T0” is set to the middle of the useful part.

Ext - Use the external trigger plus delay as the start of the useful part. “T0” is set to the middle of the useful part.

- **Advanced** - Accesses a menu to change the following parameters:

NOTE

Parameters that are under the Advanced key seldom need to be changed. Any changes from the factory default values may result in invalid measurement data.

RBW Filter - This key toggles to select a Flat Top or a Gaussian (the default filter) resolution bandwidth filter. A Gaussian filter minimizes distortion products in the time domain, particularly for bursts. A Flat Top filter provides a flatter bandwidth but is less accurate for pulse responses. A Flat Top filter also requires less memory and allows longer data acquisition times.

Res BW - Sets the resolution bandwidth.

Table 3-10

Transmit Power Measurement Defaults

| Measurement Parameter | Factory Default Condition |
|-----------------------|---------------------------|
| Averages | 50 On |

Table 3-10 **Transmit Power Measurement Defaults**

| Measurement Parameter | Factory Default Condition |
|------------------------------|----------------------------------|
| Avg Mode | Exp |
| Avg Type | Pwr Avg (RMS) |
| Threshold Lvl | -6.00 dB Rel (to peak) |
| Trig Source | RF Burst (Wideband) |
| Burst Sync | None |
| Meas Time | 1 slot |
| Advanced | |
| RBW Filter | Gaussian |
| Res BW | 500.000 kHz |

Measurement Results

Both the averaged and instantaneous results for Mean Transmit Power are displayed on the screen of the instrument. The Averaged Mean Transmit Power Above Threshold is displayed on the left of the display, while the value of the Mean Transmit Power Above Threshold for the current acquisition is displayed on the right of the screen under the heading Current Data Mean Transmit Pwr. If averaging is turned off, the two values can be the same. When you set averaging ON, the Mean Transmit Power Above Threshold is an averaged value.

Figure 3-35**Transmit Power Result - Single Burst (with data table)**

Figure 3-36 Transmit Power Result - Multiple Bursts



Waveform (Time Domain) Keys

NOTE You must have selected **Waveform** under the **MEASURE** menu to access these menus.

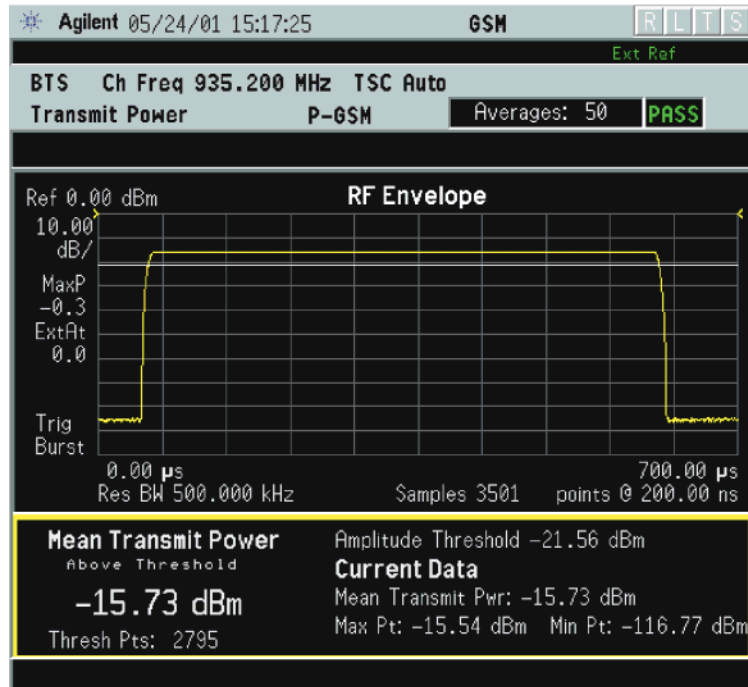
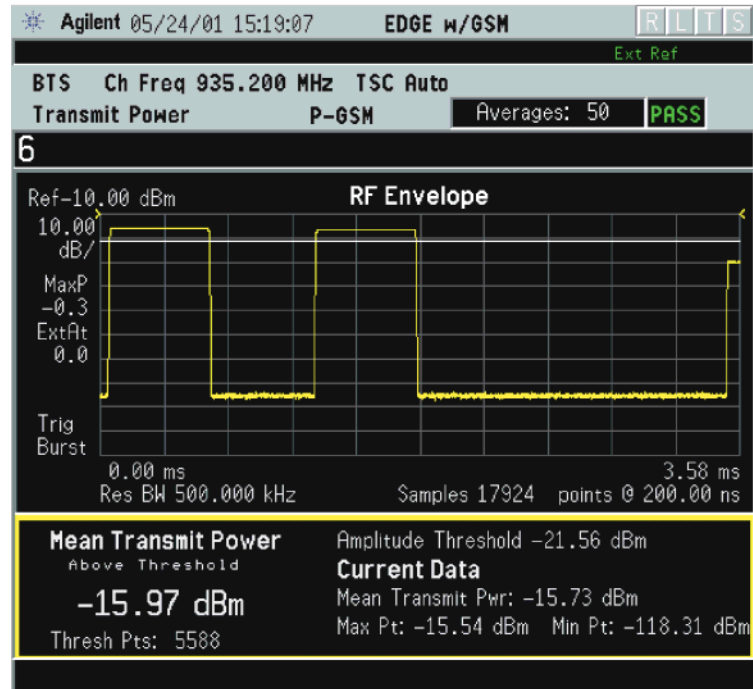
Measurement Setup Key Menu

Key Path: **Meas Setup**

- **Sweep Time** - Specifies the measurement acquisition time that is used as the length of the time capture record. The range is 1.0 μ s and 100.0 s, depending upon the resolution bandwidth setting and the available internal memory size for acquisition points.
- **Res BW** - Sets the measurement bandwidth. The range is 10 Hz to 8 MHz using the Gaussian filter selected from RBW Filter under the Advanced menu, or 10 Hz to 10 MHz using the Flat top filter selected from RBW Filter. A larger bandwidth results in a larger number of acquisition points and reduces the maximum value allowed for the sweep time.
- **Average**

Avg Number - Changes the number of N averages.

Avg Mode - Toggles the averaging mode between **Exp** (exponential) and **Repeat**. This selection only effects on the averaging result after the number of N averages is reached. The N is set using the **Avg Number** key.

Normal averaging - Normal (linear) averaging is always used until the specified number of N averages is reached. When the **Measure** key under **Meas Control** is set to **Single**, data acquisition is stopped when the number of N averages is reached, thus **Avg Mode** has no effect in the single measurement mode.

Exponential averaging - When **Measure** is set to **Cont**, data acquisition continues indefinitely. Exponential averaging is used with a weighting factor of N (the displayed count of averages stops at N). Exponential averaging weights new data more heavily than old data, which allows tracking of slow-changing signals. The weighting factor N is set using the **Avg Number** key.

Repeat averaging - When **Measure** is set to **Cont**, data acquisition continues indefinitely. After the number of N averages is reached, all previous result data is cleared and the average count displayed is set back to 1. This is equivalent to being in **Measure Single** and pressing the **Restart** key each time the single measurement finishes

Avg Type - Accesses the menu of the following average types only for making spectrum (frequency domain) and waveform (time domain) measurements:

Pwr Avg (RMS) - Executes true power averaging, which is calculated by averaging the rms voltage. This is the most accurate type.

Log-Pwr Avg (Video) - Simulates the traditional spectrum analyzer type of averaging by calculating the log of the power. This type of averaging underestimates the power when the signal is noise-like.

Voltage Avg - Executes voltage averaging.

Maximum - Captures peak voltage data. Simulates the traditional spectrum analyzer peak hold function.

Minimum - Captures the minimum voltage data, similar to the maximum function.

CAUTION

If triggering is set incorrectly, averaged signal results can approach nil. “HW Average” is displayed when averaging is ON.

TIP

If your measurement results vary or provide unexpected values, try turning Averaging OFF and execute single, non-averaged measurements to check your triggering setup. Press **Meas Control**, **Measure**, **Single** to make non-continuous measurements.

- **Trig Source**

Key path: **Meas Setup**, **Trig Source**

NOTE

Changing the selection in the **Trig Source** menu alters the trigger source for the selected measurement only.

Free Run (Immediate) - A trigger occurs at the time the data is requested, completely asynchronous with the RF or IF signal.

Video (Envlp) - An internal IF envelope trigger that occurs at the absolute threshold level of the IF signal level.

RF Burst (Wideband) - An internal wideband RF burst trigger that has the automatic level control for burst signals. It triggers at the level that is set relative to the peak RF signal (12 MHz bandwidth) input level.

Ext Front - Activates the front panel external trigger input (**EXT TRIGGER INPUT**) port. The external signal must be between –5.00 and +5.00 V with 1 or 10 mV resolution.

Ext Rear - Activates the rear-panel external trigger input

(**TRIGGER IN**) port. The external signal must be between -5.00 and $+5.00$ V with 1 or 10 mV resolution.

Frame - Uses the internal frame clock to generate a trigger signal. The clock parameters are controlled under the **Mode Setup** key or the measurement firmware, but not both. Refer to the specific measurement section for details.

Line - Sets the trigger to the internal line mode. Sweep triggers occur at intervals synchronous to the line frequency. See the specific measurement section for details.

- **Restore Meas Defaults** - Presets only the settings that are specific to the selected measurement by pressing **Meas Setup, More (1 of 2), Restore Meas Defaults**. This sets the measure setup parameters, for the currently selected measurement only, to the factory defaults.
- **(Narrowband) Advanced** - Accesses the menu to change the following parameters.

CAUTION

The advanced features should be used only if you are familiar with their operation. Changes from the default values may result in invalid data.

The **Narrowband** key label word is only present if you have Option B7J and either Option 122 or 140 installed. Parameters that are under the **(Narrowband) Advanced** key only affect the standard narrow band IF path. The wideband IF advanced functions are found under the **Wideband Advanced** key.

Pre-ADC BPF - Toggles the pre-ADC bandpass filter function between **On** or **Off**. The default setting is **Off**. The pre-ADC bandpass filter is useful for rejecting nearby signals, so that sensitivity within the span range can be improved by increasing the ADC range gain.

RBW Filter - Toggles the resolution bandwidth filter selection between **Flat** and **Gaussian**. If set to **Gaussian**, the filter provides more even time-domain response, particularly for “bursts”. If set to **Flat**, the filter provides a flatter bandwidth but is less accurate for “pulse responses”. A flat top filter also requires less memory and allows longer data acquisition times. For most waveform applications, the Gaussian filter is recommended. The resolution bandwidth range is 10 Hz to 8 MHz using the Gaussian filter or 10 Hz to 10 MHz using the Flat top filter.

ADC Range - Accesses the menu to select one of the ADC ranging functions:

Auto - Automatically adjusts the signal range for optimal measurement results.

AutoPeak - Continuously searches for the highest peak signal.

AutoPeakLock - Adjusts the range for the highest peak signal that it identifies. Retains the range settings determined by that peak signal, even when the peak signal is no longer present.

Manual - Accesses the selection menu of values, -6 to +24 dB for E4406A or None to +18 dB for PSA, to set the ADC range level. Also note that manual ranging is best for CW signals.

Data Packing - Selects **Auto** (the default) or the **Short (16 bit)**, **Medium (24 bit)** and **Long (32 bit)** methods of data packing. The short, medium, and long methods are not compatible with all settings and should not be used unless you are familiar with data packing methods. **Auto** is the preferred choice.

Auto - The data packing value most appropriate for current instrument settings is selected automatically.

Short (16 bit) - Select this to pack data every 16 bits.

Medium (24 bit) - Select this to pack data every 24 bits.

Long (32 bit) - Select this to pack data every 32 bits.

ADC Dither - Toggles the ADC dither function between **On** and **Off**. The default setting is **Off**. If set to **On**, the ADC dither introduces noise to the digitized steps of the analog-to-digital converter, and results in better amplitude linearity and resolution in low level signals. However, it also results in reduced dynamic range by approximately 3 dB.

Decimation - Toggles the decimation function between **On** and **Off**, and to set the decimation value. Decimation allows longer acquisition times for a given bandwidth by eliminating data points. Long time captures can be limited by the instrument data acquisition memory. Decimation numbers 1 to 4 describe the factor by which the number of points are reduced. The default setting is 1, which results in no data point reduction.

Table 3-11

Waveform (Time Domain) Measurement Defaults

| Measurement Parameter | Factory Default Condition |
|---|---|
| Sweep Time | 2.000 ms |
| IFBW | 500.000 kHz |
| Averaging: Avg Number Avg Mode Avg Type | 10; Off Exp Pwr Avg (RMS) |
| Trig Source | RF Burst |
| IF Path (requires Option B7J and Option 122 or 140) | Narrow |
| Wideband IF Gain (Option 122 or 140) | 0.00 dB |
| Wideband Filtering (Option 122 or 140) Filter Type Filter Alpha Filter BW | None 0.30 0.50 |
| Signal Envelope View SPAN X Scale - Scale/Div AMPLITUDE Y Scale - Scale/Div | (for E4406A) 200.0 μ s 10.00 dB |
| RF Envelope View SPAN X Scale - Scale/Div AMPLITUDE Y Scale - Scale/Div | (for PSA) 200.0 μ s 10.00 dB |
| Linear Envelope View SPAN X Scale - Scale/Div Linear Envelope window: AMPLITUDE Y Scale - Scale/Div Phase window: AMPLITUDE Y Scale - Scale/Div | (for E4406A Option B7C) 200.0 μ s 100.0 mV 30.0 deg |
| I/Q Waveform View: SPAN X Scale -Scale/Div AMPLITUDE Y Scale - Scale/Div | 200.0 μ s 100.0 mV |
| I and Q Waveform View: SPAN X Scale -Scale/Div AMPLITUDE Y Scale - Scale/Div | (for E4406A Option B7C) 200.0 μ s 100.0 mV |
| I/Q Polar View: I/Q Scale/Div I or Q Origin | (for E4406A) 100.0 mV 0.00 V |
| (Narrowband) Advanced | |
| Pre-ADC BPF | Off |

Table 3-11 **Waveform (Time Domain) Measurement Defaults**

| Measurement Parameter | Factory Default Condition |
|------------------------------|----------------------------------|
| RBW Filter | Gaussian |
| ADC Range | Auto |
| Data Packing | Auto |
| ADC Dither | Off |
| Decimation | Off |

Key Reference
Measurement Keys

View/Trace Key Menu

Key Path: View/Trace

- **RF Envelope** - Displays a time domain graph of the signal. The measured values for the mean power and peak-to-mean power are shown in the text window.

Figure 3-37 Waveform Measurement - RF Envelope (Default View)

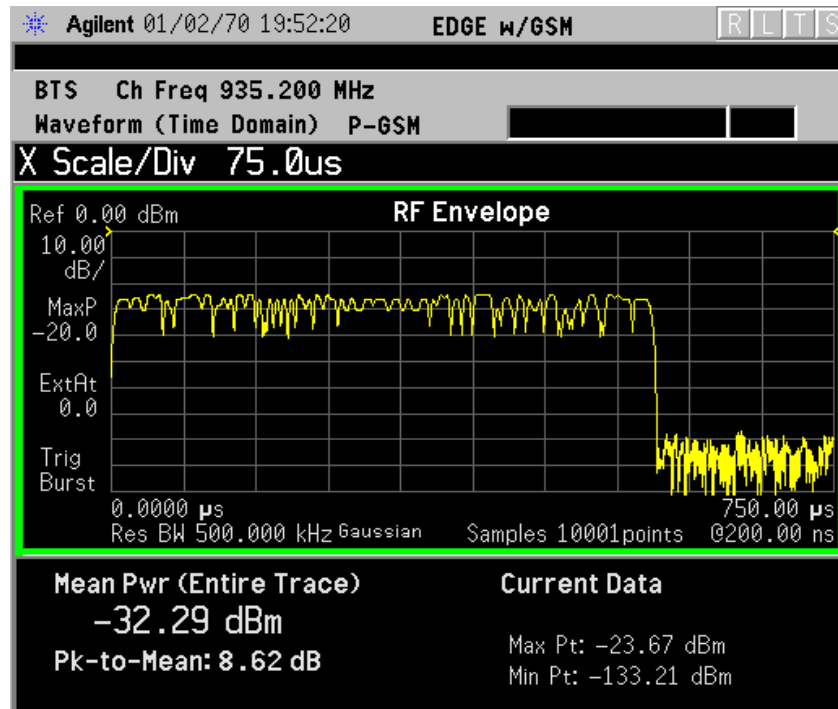
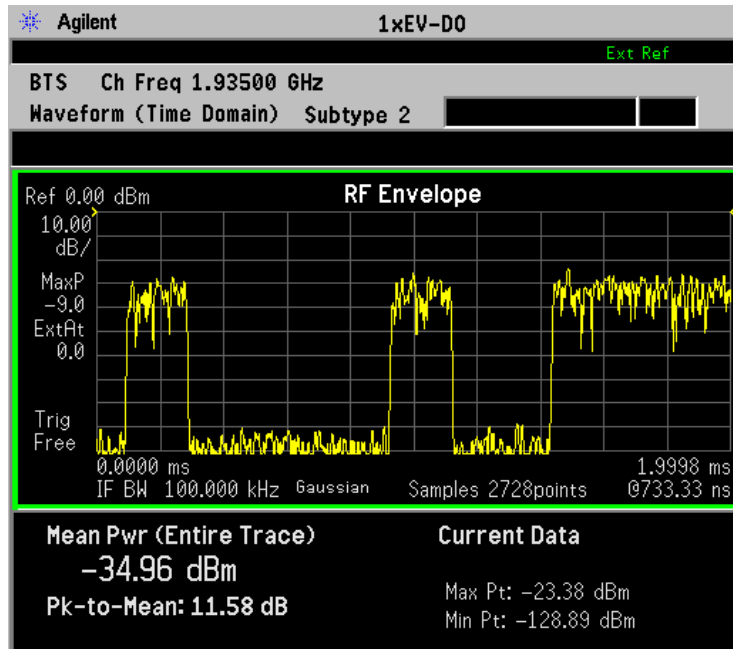

Figure 3-38 Waveform Measurement - RF Envelope (Default View)



*Meas Setup: Trace/View = RF Envelope,
Others = Factory default settings

*Input signal: cdma2000 Rev 8, SR1, 9 Channel

Figure 3-39 Linear Envelope - (for E4406A Option B7C) Provides a combination view of a linear signal envelope graph and a phase graph with linear graticules. Use the **Next Window** and **Zoom** keys to select and enlarge either graph.

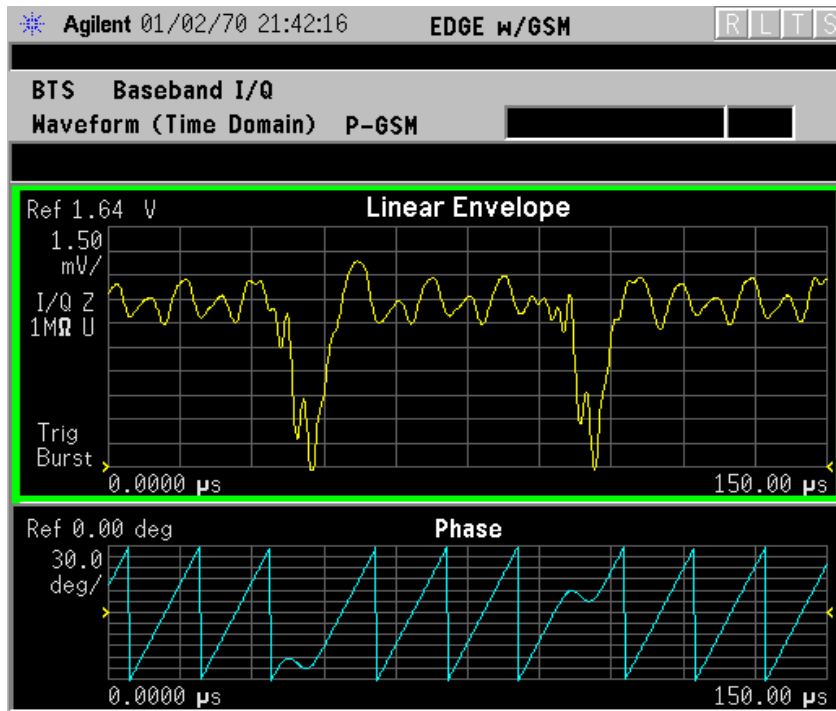
Figure 3-40 Waveform Measurement - Linear Envelope View

- **I/Q Waveform** - Provides a view of the I and Q waveforms together on the same graph in parameters of voltage versus time in linear scale. Changes to sweep time or resolution bandwidth can affect data acquisition.

Figure 3-41

Waveform Measurement - I/Q Waveform View

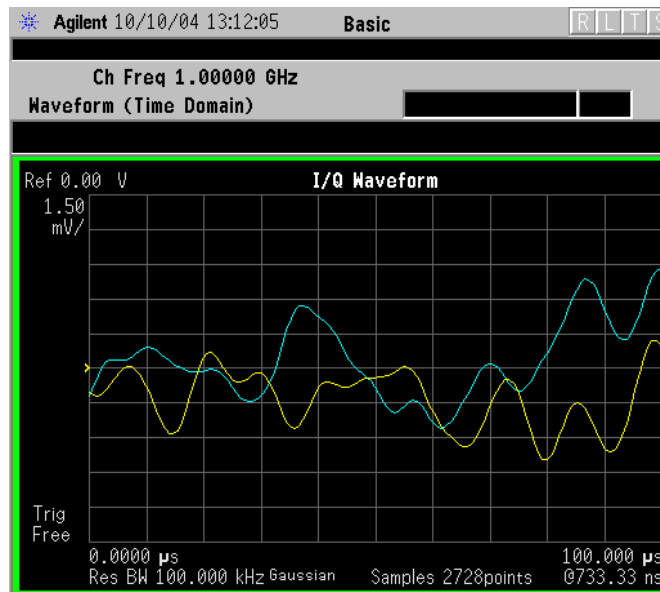

NOTE

For the widest spans, the I/Q Waveform window becomes just “ADC time domain samples”, because the I/Q down-conversion is no longer in effect.

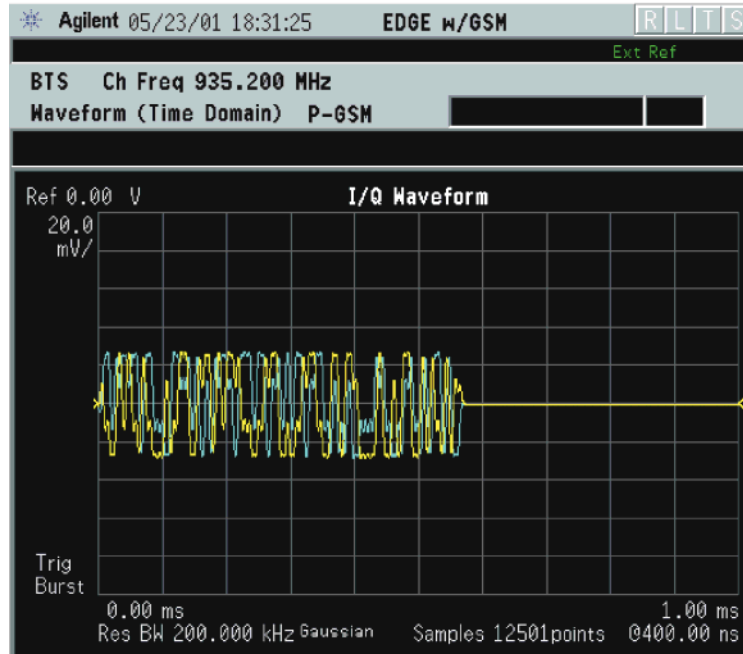
Figure 3-42 Waveform Measurement - I/Q Waveform View**NOTE**

For the widest spans the I/Q Waveform window becomes just “ADC time domain samples”, because the I/Q down-conversion is no longer in effect.

- **I and Q Waveform** - (for E4406A Option B7C) Provides a combination view of the I and Q signal waveform graphs in the linear scales.

Figure 3-43 Waveform Measurement - I and Q Waveform View

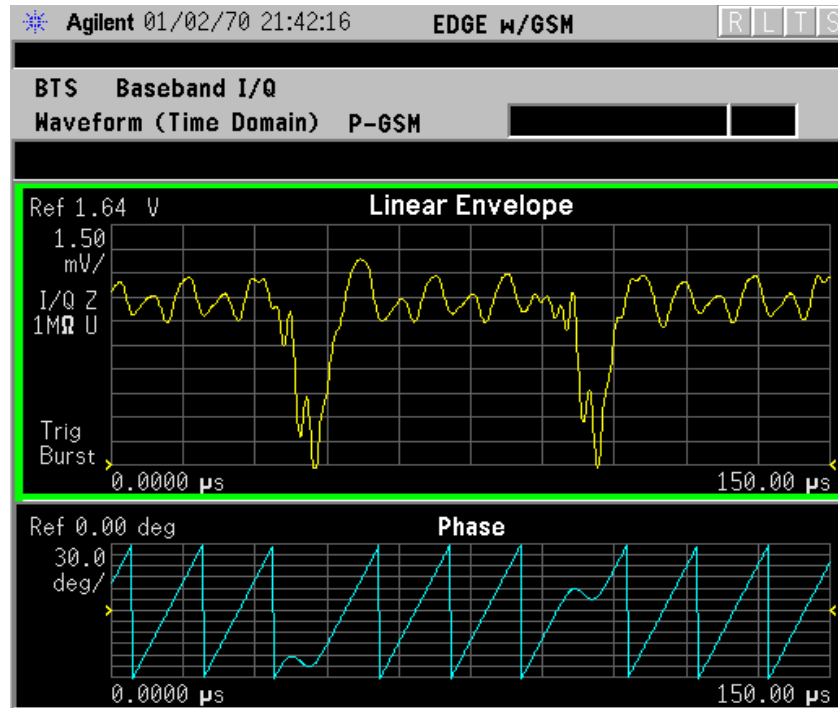

Key Reference
Measurement Keys

- I/Q Polar - (for E4406A) Provides a view of the I/Q signal in a polar vector graph.

Figure 3-44 Waveform Measurement - I/Q Polar View

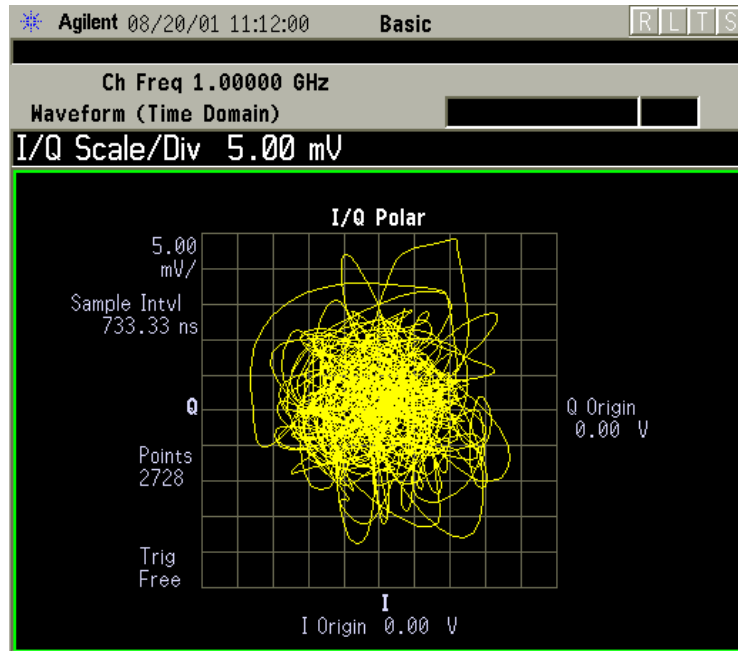
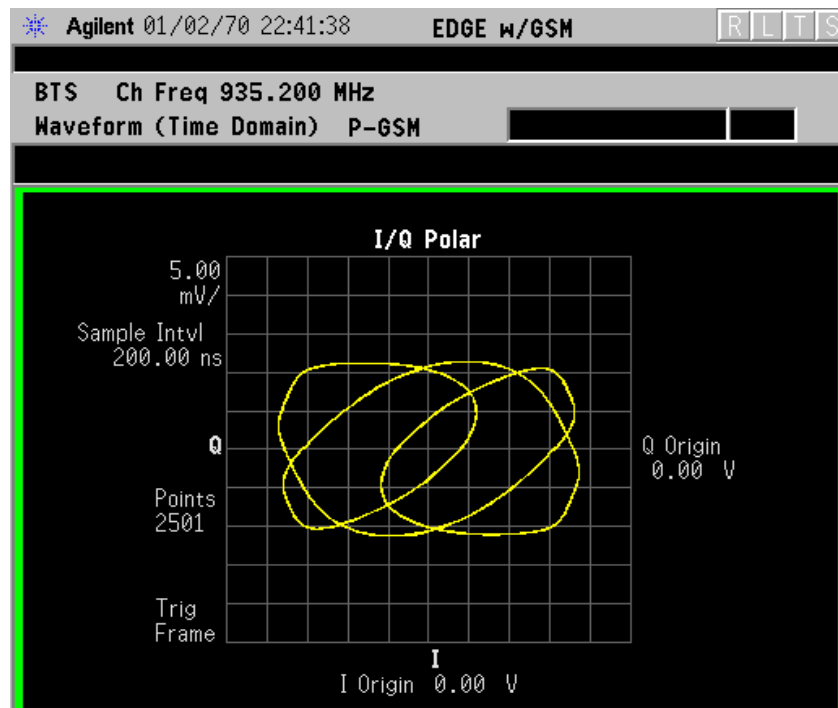

Figure 3-45 Waveform Measurement - I/Q Polar View



*Meas Setup: View/Trace = I/Q Polar View,
Others = Factory defaults, except X and Y scales

*Input signal: cdma2000 Rev 8, SR1, 9 Channel

- **Trace Display** - Press this key to access the trace selection menu. The currently selected trace type is shown on the **Trace Display** key.

All - Views both the current trace and the average trace.

Average - Views only the average trace (in blue color). See the **Meas Setup**, **Average** keys to select different types of averaging.

Current - Views only the trace (in yellow color) for the latest data acquisition.

I Trace - (for E4406A) Views only the I signal trace.

Q Trace - (for E4406A) Views only the Q signal trace.

SPAN X Scale Key Menu

Key Path: **Span X Scale**

NOTE

The **SPAN X Scale** key accesses the menu to modify the horizontal parameters common to the scaled windows for this measurement. Use the **Sweep Time** key under the **Meas Setup** menu to control the horizontal time span for this measurement:

- **Scale/Div** - Sets the horizontal scale by changing a time value per division. The range is 1.0 ns to 1.000 s per division with 0.01 ns resolution. The default setting is 200.0 μ s per division. However, since the **Scale Coupling** default is **On**, this value is automatically determined by the measurement result. When you set a value manually, **Scale Coupling** automatically changes to **Off**.
- **Ref Value** - Sets the reference value ranging from -1.0 to 10.0 s. The default setting is 0.00 s. However, since the **Scale Coupling** default is **On**, this value is automatically determined by the measurement result. When you set a value manually, **Scale Coupling** automatically changes to **Off**.
- **Ref Position** - Sets the reference position to either **Left**, **Ctr** (center) or **Right**. The default setting is **Left**.
- **Scale Coupling** - Toggles the scale coupling function between **On** and **Off**. The default setting is **On**. Upon pressing the **Restart** front-panel key or **Restart** softkey under the **Meas Control** menu, this function automatically determines the scale per division and reference values based on the measurement results. When you set a value to either **Scale/Div** or **Ref Value** manually, **Scale Coupling** automatically changes to **Off**.

NOTE

For E4406A, if the I/Q Polar window is active in the I/Q Polar view, the **SPAN X Scale** key accesses the following menu:

Key Reference

Measurement Keys

- **I/Q Scale/Div** - Sets the vertical and horizontal scales by changing a value per division. The range is 1.00 nV to 20.00 V per division. The default setting is 100.0 mV.
- **I or Q Origin** - Sets the reference value ranging from -250.00 to 250.00 V. The default setting is 0.00 V.

AMPLITUDE Y Scale Key Menu

Key Path: **AMPLITUDE Y Scale**

NOTE

If the **RF Envelope** (for PSA) or **Signal Envelope** (for E4406A) window is active in the **RF Envelope** (for PSA) or **Signal Envelope** (for E4406A) view, the **AMPLITUDE Y Scale** key accesses the following menu:

- **Scale/Div** - Sets the vertical scale by changing an amplitude value per division. The range is 0.10 to 20.00 dB per division with 0.01 dB resolution. The default setting is 10.00 dB per division. However, since the **Scale Coupling** default is **On**, this value is automatically determined by the measurement result. When you set a value manually, **Scale Coupling** automatically changes to **Off**.
- **Ref Value** - Sets the reference value ranging from -250.00 to 250.00 dBm. The default setting is 0.00 dBm. However, since the **Scale Coupling** default is **On**, this value is automatically determined by the measurement result. When you set a value manually, **Scale Coupling** automatically changes to **Off**.
- **Ref Position** - Sets the reference position to either **Top**, **Ctr** (center) or **Bot** (bottom). The default setting is **Top**.
- **Scale Coupling** - Toggles the scale coupling function between **On** and **Off**. The default setting is **On**. Upon pressing the **Restart** front-panel key or **Restart** softkey under the **Meas Control** menu, this function automatically determines the scale per division and reference values based on the measurement results. When you set a value to either **Scale/Div** or **Ref Value** manually, **Scale Coupling** automatically changes to **Off**.

NOTE

For E4406A with Option B7C, if the **Linear Envelope** window is active in the **Linear Envelope** view, the **AMPLITUDE Y Scale** key accesses the following menu:

- **Scale/Div** - Sets the vertical scale by changing an amplitude value per division. The range is 1.00 nV to 20.00 V per division. The default setting is 100.0 mV per division. However, since the **Scale Coupling** default is **On**, this value is automatically determined by the measurement result. When you set a value manually, **Scale Coupling** automatically changes to **Off**.
- **Ref Value** - Sets the reference value ranging from -250.00 to 250.00 V. The default setting is 0.00 V. However, since the **Scale Coupling** default is **On**, this value is automatically determined by the measurement result. When you set a value manually, **Scale Coupling** automatically changes to **Off**.
- **Ref Position** - Sets the reference position to either **Top**, **Ctr** (center) or **Bot** (bottom). The default setting is **Top**.

Key Reference
Measurement Keys

- **Scale Coupling** - Toggles the scale coupling function between **On** and **Off**. The default setting is **On**. Upon pressing the **Restart** front-panel key or **Restart** softkey under the **Meas Control** menu, this function automatically determines the scale per division and reference values based on the measurement results. When you set a value to either **Scale/Div** or **Ref Value** manually, **Scale Coupling** automatically changes to **Off**.

NOTE

For E4406A with Option B7C, if the Phase window is active in the **Linear Envelope** view, the **AMPLITUDE Y Scale** key accesses the menu to modify the following parameters:

- **Scale/Div** - Sets the vertical scale by changing an amplitude value per division. The range is 0.10 to 3600.0 deg per division. The default setting is 30.00 deg. However, since the **Scale Coupling** default is **On**, this value is automatically determined by the measurement result. When you set a value manually, **Scale Coupling** automatically changes to **Off**.
- **Ref Value** - Sets the reference value ranging from -36000.0 to 36000.0 deg. The default setting is 0.00 deg. However, since the **Scale Coupling** default is **On**, this value is automatically determined by the measurement result. When you set a value manually, **Scale Coupling** automatically changes to **Off**.
- **Ref Position** - Sets the reference position to either **Top**, **Ctr** (center) or **Bot** (bottom). The default setting is **Ctr**.
- **Scale Coupling** - Toggles the scale coupling function between **On** and **Off**. The default setting is **On**. Upon pressing the **Restart** front-panel key or **Restart** softkey under the **Meas Control** menu, this function automatically determines the scale per division and reference values based on the measurement results. When you set a value to either **Scale/Div** or **Ref Value** manually, **Scale Coupling** automatically changes to **Off**.

NOTE

If the I/Q Waveform window is active in the **I/Q Waveform** view (or the I Waveform, or Q Waveform window is active in the **I and Q Waveform** view for E4406A with Option B7C), the **AMPLITUDE Y Scale** key accesses the menu to modify the following parameters:

- **Scale/Div** - Sets the vertical scale by changing an amplitude value per division. The range is 1.00 nV to 20.00 V per division. The default setting is 100.0 mV. However, since the **Scale Coupling** default is **On**, this value is automatically determined by the measurement result. When you set a value manually, **Scale Coupling** automatically changes to **Off**.
- **Ref Value** - Sets the reference value ranging from -250.00 to 250.00 V. The default setting is 0.00 V. However, since the **Scale Coupling**

default is **On**, this value is automatically determined by the measurement result. When you set a value manually, **Scale Coupling** automatically changes to **Off**.

- **Ref Position** - Sets the reference position to either **Top**, **Ctr** (center) or **Bot** (bottom). The default setting is **Ctr**.
- **Scale Coupling** - Toggles the scale coupling function between **On** and **Off**. The default setting is **On**. Upon pressing the **Restart** front-panel key or **Restart** softkey under the **Meas Control** menu, this function automatically determines the scale per division and reference values based on the measurement results. When you set a value to either **Scale/Div** or **Ref Value** manually, **Scale Coupling** automatically changes to **Off**.

NOTE

For E4406A, if the I/Q Polar window is active in the I/Q Polar view, the **SPAN X Scale** or **AMPLITUDE Y Scale** key accesses the menu to modify the following parameters:

- **I/Q Scale/Div** - Sets the vertical and horizontal scales by changing a value per division. The range is 1.00 nV to 20.00 V per division. The default setting is 100.0 mV.
- **I or Q Origin** - Sets the reference value ranging from -250.00 to 250.00 V. The default setting is 0.00 V.

Display Key Menu

The **Display** key is not available for this measurement.

Marker Key Menu

Key Path: **Marker**

The **Marker** front-panel key accesses the menu to configure the markers.

- **Select 1 2 3 4** - Activates up to four markers with the corresponding numbers, respectively. The selected number is underlined and its function is defined by pressing the **Function** key. The default is 1.
- **Normal** - Activates the selected marker to read the time position and amplitude of the marker on the RF envelope or Signal Envelope trace. Marker position is controlled by the **RPG** knob.
- **Delta** - Reads the differences in frequency and either time position or amplitude, between the selected marker and the next marker.
- **Function Off** - Selects the marker function to be **Band Power**, **Noise**, or **Off**. The default is **Off**. If set to **Band Power**, you need to select **Delta**.
- **Trace** - Places the selected marker on **RF Envelope** (for PSA), **Signal Envelope** (for E4406A), or **I/Q Waveform**. Also, for E4406A with Option B7C, you can place the marker on **Linear Envelope**, **Linear Phase**, **I Waveform**, or **Q Waveform**.

[Key Reference](#)[Measurement Keys](#)

- **Off** - Turns off the selected marker.
- **Shape Diamond** - Accesses the menu to define the selected marker shape to be **Diamond**, **Line**, **Square**, or **Cross**. The default shape is **Diamond**.
- **Marker All Off** - Turns off all of the markers.

Peak Search Key

Key Path: **Search**

The front panel **Search** key performs a peak search when pressed. A marker is automatically activated at the highest peak.

NOTE

In the Waveform measurement, the Mean Pwr (Entire Trace) value plus the Pk-to-Mean value sums to equal the current Max Pt. value as shown in the data window below the RF Envelope or Signal Envelope display. If you do a marker peak search (**Search**) with averaging turned off, the marker finds the same maximum point. However, if you turn averaging on, the Pk-to-Mean value uses the highest peak found for any acquisition during averaging, while the marker peak looks for the peak of the display, which is the result of n-averages. This usually results in differing values for the maximum point.

Baseband I/Q Inputs (Option B7C) Keys

Input Port Key Menu

Key Path: **Mode Setup**, **Input**

Option B7C adds a softkey menu that lets you select I/Q inputs. This menu is located under the **Input/Output** front-panel key. To select an input connector press **Input/Output**, or **Input Port** under **Mode Setup**. Select the desired input connector(s) from the following choices displayed:

- **RF** - Press to select the 50 Ω N-type RF connector.
- **I/Q** - Select if using 2-connector “unbalanced” or 4-connector “balanced” I/Q connections. Complete your selection by choosing the appropriate input impedance and connectors in the section “[I/Q Input Z Key Menu](#)” on page 260.
- **I only** - Select if using I and/or \bar{I} input connectors (available in the Basic mode). Complete your selection by choosing the appropriate input impedance and connectors in the section “[I/Q Input Z Key Menu](#)” on page 260.
- **Q only** - Select if using Q and/or \bar{Q} input connectors (available in the Basic mode). Complete your selection by choosing the appropriate input impedance and connectors in the section “[I/Q Input Z Key Menu](#)” on page 260.
- **50 MHz Ref** - Select to view the 50 MHz CW calibration signal (signal level is approximately -25.0 dBm).
- **IF Align** - Select to view the IF alignment signal. This signal is available as a diagnostic function, to check the operation of the alignment signal in the case of alignment failure. Once selected, a menu accessing the IF alignment signal parameters is available at the bottom of the **Input** menu. Either CW, comb, or pulse signals may be selected. Because the alignment signal is input at the IF frequency, it is displayed on any active Spectrum (Freq Domain) window, regardless of center frequency.
- **Baseband Align Signal** - Select **On** to view the baseband alignment signal. This is available as a diagnostic function, to check the operation of the alignment signal in the case of alignment failure. Because the alignment signal is input at the IF frequency, it is displayed on any Spectrum (Freq Domain) window.

I/Q Setup Key Menu

Key Path: **Mode Setup, Input**

- **I Offset** - Use to enter a voltage value to offset the measured I value. The default value is 0.0000 V. The range is -2.5600 to $+2.5600$ V. The tuning increment depends on the **I/Q Range** setting as shown in [Table 3-12](#). This value only affects the displayed results, and does not appear as a correcting voltage at the probe.

Table 3-12

I and Q Offset Increment vs. I/Q Range

| I/Q Range | I and Q Offset Increment |
|-----------|--------------------------|
| 1 V | 2 mV |
| 500 mV | 1 mV |
| 250 mV | .5 mV |
| 125 mV | .25 mV |

- **Q Offset** - Use to enter a voltage value to offset the measured Q value. The default value is 0.0000 V. The range is -2.5600 to $+2.5600$ V. The tuning increment depends on the **I/Q Range** setting as shown in [Table 3-12](#). This value only affects the displayed results, and does not appear as a correcting voltage at the probe.
- **I/Q Input Z** - Allows you to access a menu to select an input impedance for baseband I/Q input signals. The selection of input impedance is coupled to a connector “balance” configuration. If **I/Q Input Z** is set to 1 M Ω , the setting for **I/Q Z Ref for Input Z = 1 M Ω** key becomes effective. For details, refer to “[I/Q Input Z Key Menu](#)” on page 260.
- **I/Q Z Ref for Input Z = 1 M Ω** - Allows you to select the 1 M Ω input reference Z value in Ohms. This key is effective only when **I/Q Input Z** is set to a 1 M Ω setting. The default value is 50.0 Ω . The range is 1.0 Ω to 10 M Ω , with a tuning increment of 1.0 Ω . For more details, refer to “[I/Q Input Z Key Menu](#)” on page 260.

I/Q Input Z Key Menu

Key Path: **Mode Setup, Input, I/Q Setup**

To select an input impedance, press **Input/Output, I/Q Setup, I/Q Input Z** to display the following menu:

- **50 Ω Unbalanced** - Select to use I and/or Q input connectors.
- **600 Ω Balanced** - Select to use either I and \bar{I} , Q and \bar{Q} , or all four I, Q, \bar{I} , and \bar{Q} input connectors.
- **1 M Ω Unbalanced** - This is the default input connector setting. Select to use I and/or Q input connectors in an unbalanced mode. When **I/Q Input Z** is set to 1 M Ω (either balanced or unbalanced), the setting for

I/Q Z Ref for Input Z = 1 M Ω key may be adjusted. Otherwise, the default value for I/Q Z Ref = 1 M Ω is 50 Ω .

- **1 M Ω Balanced** - Select to use either I and \bar{I} , Q and \bar{Q} , or all four I, Q, \bar{I} , and \bar{Q} input connectors to make a balanced measurement. When I/Q Input Z is set to 1 M Ω (either balanced or unbalanced, the setting for I/Q Z Ref for Input Z = 1 M Ω key may be adjusted. Otherwise, the default value for I/Q Z Ref for Input Z = 1 M Ω is 50 Ω .

I/Q Range Key Menu

NOTE You must have I/Q selected under Key Path: Mode Setup, Input, Input Port to make this menu available

Key Path: **Mode Setup, Input**

The **I/Q Range** key lets you select one of four levels as an upper limit for the signal being applied to the baseband I/Q inputs. The level may be selected in units of dBm, dBmV, dB μ V, V, and W. The following table shows the four-level selections available for each unit of measure: The default is 1 V.

The **I/Q Range** power levels in [Table 3-13](#) are based on an **I/Q Input Z** of 50 Ω . **I/Q Range** voltage levels are independent of **I/Q Input Z**.

Table 3-13

I/Q Range Settings by Displayed Unit of Measure

| Unit of Measure | Highest Setting | | | Lowest Setting |
|-----------------|-----------------|-------|-------|----------------|
| dBm | 13.0 | 7.0 | 1.0 | -5.1 |
| dBmV | 60 | 54 | 48 | 41.9 |
| dB μ V | 120.0 | 114.0 | 108 | 101.9 |
| V | 1.000 | 500 m | 250 m | 125 m |
| W | 20.0 m | 5.0 m | 1.2 m | 310.0 μ |

If **I/Q Range** is set below the default and the error message “Input Overload” is displayed, this value may be adjusted to its maximum. Beyond that point, the signal must be attenuated to preserve the measurement accuracy. Using a lower value than the default can provide an increased dynamic measurement range.

Baseband I/Q Key Access Locations

All baseband I/Q input setup and operation features can be located by using the key access table below. The key access path shows the key sequence you enter to access a particular key.

Some features can only be used when specific measurements are active. If a feature is not currently valid the key label for that feature appears as lighter colored text or is not displayed at all.

Table 3-14 Baseband I/Q Key Access Locations

| Key | Key Access Path |
|------------------------------|------------------------------------|
| Align IQ | System>Alignments>Align Subsystem> |
| Baseband Align Signal | Mode Setup>Input>Input Port> |
| dBm | Input/Output>I/Q Range> |
| dBm | Mode Setup>Input>I/Q Range> |
| dBmv | Input/Output>I/Q Range> |
| dBmv | Mode Setup>Input>I/Q Range> |
| dBuv | Input/Output>I/Q Range> |
| dBuv | Mode Setup>Input>I/Q Range> |
| I and Q Waveform | View/Trace> (Waveform Measurement) |
| I Offset | Input/Output>I/Q Setup> |
| I Offset | Mode Setup>Input>I/Q Setup> |
| I/Q | Input/Output>Input Port> |
| I/Q | Mode Setup>Input>Input Port> |
| I/Q Input Z | Input/Output>I/Q Setup> |
| I/Q Input Z | Mode Setup>Input>I/Q Setup> |
| I/Q Polar | View/Trace> |
| I/Q Range | Input/Output> |
| I/Q Range | Mode Setup>Input> |
| I/Q Setup | Input/Output> |
| I/Q Setup | Mode Setup>Input> |
| I/Q Waveform | View/Trace> |
| I/Q Waveform | Marker>Trace> |
| I/Q Z Ref for Input Z = 1 MΩ | Mode Setup>Input>I/Q Setup> |
| I Waveform | View/Trace> (Spectrum Measurement) |

Key Reference
 Baseband I/Q Inputs (Option B7C) Keys

Table 3-14 Baseband I/Q Key Access Locations

| Key | Key Access Path |
|------------------------|--|
| Linear Envelope | View/Trace> (Waveform Measurement) |
| Q Offset | Input/Output>Input>I/Q Setup> |
| Q Offset | Mode Setup>Input>I/Q Setup> |
| Q Waveform | Marker>Trace> |
| Signal Envelope | View/Trace> (Waveform Measurement) |
| Spectrum Linear | View/Trace> (Spectrum Measurement) |
| V(olts) | Mode Setup>Input>I/Q Setup>I Offset (or Q Offset)>Keypad Entry |
| Volts | Input/Output>I/Q Range> |
| Volts | Mode Setup>Input>I/Q Range> |
| Watts | Input/Output>I/Q Range> |
| Watts | Mode Setup>Input>I/Q Range> |

4 Programming Commands

These commands are only available when the GSM or EDGE/GSM mode has been selected using `INSTRUMENT:SElect EDGEGSM`. If the GSM or EDGE/GSM mode is selected, commands that are unique to another mode are not available.

SCPI Command Subsystems

- “CALCulate Subsystem” on page 272
- “CONFigure Subsystem” on page 319
- “DISPlay Subsystem” on page 320
- “FETCh Subsystem” on page 338
- “FORMat Subsystem” on page 339
- “INITiate Subsystem” on page 341
- “INSTrument Subsystem” on page 343
- “MEASure Group of Commands” on page 347
- “READ Subsystem” on page 387
- “SENSe Subsystem” on page 388
- “TRIGger Subsystem” on page 514

Programming Command Compatibility Across Model Numbers and Across Modes

Across PSA Modes: Command Subsystem Similarities

When you select different modes you get different sets of available programming commands. That is, *only* the commands that are appropriate for the current mode are available. Also, some commands have the same syntax in different modes but have different ranges or settings that are only appropriate to the current mode.

The following table shows which command subsystems are the same across different modes. If there is no “X” by a particular subsystem, then the set of available commands is different in those modes. Command ranges or defaults may also be different. Refer to the programming command descriptions in the documentation for each mode for details.

| Command Subsystem | Same command set is available: SA mode compared with the application modes: Digital Modulation, Basic, WLAN, W-CDMA, cdmaOne, cdma2000, 1xEV-DO, GSM, EDGE, NADC, PDC, or Measuring Receiver | Same command set is available: SA mode compared with the application modes: Phase Noise, Noise Figure, TD-SCDMA |
|----------------------|---|--|
| IEEE common commands | X | X |
| ABORt | X | X |
| CALCulate | | |
| CALibration | X | X |
| CONFigure | | |
| COUPle | not available in these application modes | not available in these application modes |
| DISPlay | | |
| FETCh | | |
| FORMat | | X |
| HCOPy | X | X |
| INITiate | | |

| Command Subsystem | Same command set is available: SA mode compared with the application modes: Digital Modulation, Basic, WLAN, W-CDMA, cdmaOne, cdma2000, 1xEV-DO, GSM, EDGE, NADC, PDC, or Measuring Receiver | Same command set is available: SA mode compared with the application modes: Phase Noise, Noise Figure, TD-SCDMA |
|---|---|--|
| INPut | not available in these application modes | X |
| MEASure | | |
| MEMory | X | X |
| MMEMory | X | X |
| MMEMory:STORe:TRACe | not available in these application modes | X |
| READ | | |
| [SENSe] [SENSe:]CHANnel [SENSe:]CORRection [SENSe:]FEED [SENSe:]FREQuency:CE NTer [SENSe:]FREQuency: <other subsystems> [SENSe:]<measurement> [SENSe:]POWer [SENSe:]RADio [SENSe:]SYNC | X not available in these application modes | not available in these application modes |
| STATus | X | X |
| SYSTem | X | X |
| TRACe | not available in these application modes | X |
| TRIGger | | |
| UNIT | X | X |

Across PSA Modes: Specific Command Differences

Some programming commands operate differently depending on which Mode the analyzer is set to.

| Command | Spectrum Analysis, Phase Noise and Noise Figure Mode | Basic, cdmaOne, cdma2000, 1xEV-DO, W-CDMA, GSM, EDGE, NADC, PDC Modes |
|-----------------------------|--|---|
| CONFigure: <measurement> | Accesses the measurement and sets the instrument settings to the defaults. Averaging is turned on and set to 10. The instrument is put in single measurement mode. It does not initiate a measurement. Use INIT:IMM to make one measurement. | Accesses the measurement and sets the instrument settings to the defaults. If you were already in single measurement mode, it takes one measurement and then waits. If you were in continuous measurement mode it continues to measure. |
| *ESE default | Default is 255 which means that every error/status bit change that has occurred will be returned with a *ESR? query. You must set the value of *ESE to choose only the bits/status that you want returned. | Default is 0 which means that none of the error/status bit changes that have occurred will be returned with a *ESR? query. You must set the value of *ESE to choose the bits/status that you want returned. |
| TRIGger commands | For these modes, only one trigger source can be selected and it will be common across the modes. Also, only one value can be set for the trigger delay, level, or polarity. | For these modes, a unique trigger source can be selected for each mode. Also, each trigger source can have unique settings for the its delay, level, and polarity. |
| Saving and recalling traces | Traces can only be saved when in the Spectrum Analysis mode (MMEM:STOR:TRAC). This is because the instrument state must be saved along with the trace data and the state data varies depending on the number of modes currently available in the instrument. | |

Using Applications in PSA Series vs. VSA E4406A

NOTE

This information *only* applies to the application modes: Basic, cdmaOne, cdma2000, 1xEV-DO, W-CDMA, GSM, EDGE, NADC, and PDC.

| Command | PSA Series | VSA E4406A: A.04.00 | VSA E4406A: A.05.00 |
|-----------------------------|--|---|---|
| *RST | Resets instrument, putting it in continuous measurement mode. Use INIT:CONT OFF to select single measurement mode and INIT:IMM to start one measurement. | Resets instrument, putting it in single measurement mode. One measurement is initiated when the command is sent. | Resets instrument, putting it in single measurement mode. No measurement is initiated when the command is sent. Use INIT:IMM to start one measurement. |
| CONFigure: <measurement> | Accesses the measurement and sets the instrument settings to the defaults. If you were already in single measurement mode, it takes one measurement and then waits. | Same as PSA. Accesses the measurement and sets the instrument settings to the defaults. If you were already in single measurement mode, it takes one measurement and then waits. | Accesses the measurement and sets the instrument settings to the defaults. If you were already in single measurement mode, it does not initiate a measurement. Use INIT:IMM to make one measurement. |
| *ESE default | Default is 255 which means that every error/status bit change that has occurred will be returned with a *ESR? query. You must set the value of *ESE to choose only the bits/status that you want returned. | Default is 0 which means that none of the error/status bit changes that have occurred will be returned with a *ESR? query. You must set the value of *ESE to choose the bits/status that you want returned. | Same as VSA A.04.00. Default is 0 which means that none of the error/status bit changes that have occurred will be returned with a *ESR? query. You must set the value of *ESE to choose the bits/status that you want returned. |
| *LRN | The command is <i>not</i> available. | The command is available. | The command is available. |

| Command | PSA Series | VSA E4406A: A.04.00 | VSA E4406A: A.05.00 |
|---|--|--|--|
| TRIGger commands | <p>In Spectrum Analysis mode only one value can be set for the trigger's source, delay, level, or polarity.</p> <p>Basic, GSM, EDGE, cdmaOne, cdma2000, W-CDMA, NADC, PDC modes function the same as VSA</p> | <p>You can select a unique trigger source for each mode. Each trigger source can have unique settings for the delay, level, and polarity parameters.</p> | <p>Same as VSA A.04.00.</p> <p>You can select a unique trigger source for each mode. Each trigger source can have unique settings for the delay, level, and polarity parameters.</p> |
| AUTO ON OFF control and setting manual values | <p>We recommend that you set a function's automatic state to OFF, before you send it your manual value.</p> <p>Some functions will turn off the automatic mode when you send a specific manual value, but others will not. This also varies with the instrument model.</p> | <p>We recommend that you set a function's automatic state to OFF, before you send it your manual value.</p> <p>Some functions will turn off the automatic mode when you send a specific manual value, but others will not. This also varies with the instrument model.</p> | <p>We recommend that you set a function's automatic state to OFF, before you send it your manual value.</p> <p>Some functions will turn off the automatic mode when you send a specific manual value, but others will not. This also varies with the instrument model.</p> |

CALCulate Subsystem

This subsystem is used to perform post-acquisition data processing. In effect, the collection of new data triggers the CALCulate subsystem. In this instrument, the primary functions in this subsystem are markers and limits.

The SCPI default for data output format is ASCII. The format can be changed to binary with FORMat:DATA which transports faster over the bus.

Test Current Results Against all Limits

:CALCulate:CLIMits:FAIL?

Queries the status of the current measurement limit testing. It returns a 0 if the measured results pass when compared with the current limits. It returns a 1 if the measured results fail any limit tests.

Data Query

:CALCulate:DATA [n] ?

Returns the designated measurement data for the currently selected measurement and sub-opcode.

n = any valid sub-opcode for the current measurement. See the [“MEASure Group of Commands” on page 347](#) for information on the data that can be returned for each measurement.

For sub-opcodes that return trace data use the **:CALCulate:DATA [n] :COMPRESS?** command. See the Section [“Calculate/Compress Trace Data Query” on page 272](#).

Calculate/Compress Trace Data Query

:CALCulate:DATA<n>:COMPRESS?
BLOCK | CFIT | MAXimum | MINimum | MEAN | DMEan | RMS | SAMPLE | SDEVIation
| PPHase [, <soffset> [, <length> [, <roffset> [, <rlimit>]]]]

Returns compressed data for the specified trace data. The data is returned in the same units as the original trace and only works with the currently selected measurement. The command is used with a sub-opcode *<n>* since measurements usually return several types of trace data. See the following table for the sub-opcodes for the trace data names that are available in each measurement. For sub-opcodes that return scalar data use the **:CALCulate:DATA[n]?** command above.

This command is used to compress or decimate a long trace to extract and return only the desired data. A typical example would be to acquire N frames of GSM data and return the mean power of the first burst in each frame. The command can also be used to identify the best curve fit for the data.

- **BLOCK** or block data - returns all the data points from the region of the trace data that you specify. For example, it could be used to return the data points of an input signal over several timeslots, excluding the portions of the trace data that you do not want.
- **CFIT** or curve fit - applies curve fitting routines to the data. <soffset> and <length> are required to define the data that you want. <roffset> is an optional parameter for the desired order of the curve equation. The query returns the following values: the x-offset (in seconds) and the curve coefficients ((order + 1) values).

MAX, **MEAN**, **MIN**, **RMS**, **SAMP**, **SDEV** and **PPH** return one data value for each specified region (or <length>) of trace data, for as many regions as possible until you run out of trace data (using <roffset> to specify regions). Or they return the number regions you specify (using <rlimit>) ignoring any data beyond that.

- **MAXimum** - returns the maximum data point for the specified region(s) of trace data. For I/Q trace data, the maximum magnitude of the I/Q pairs is returned.
- **MEAN** - returns the arithmetic mean of the data point values for the specified region(s) of trace data. See “[Mean Value of Data Points for Specified Region\(s\)](#)” on page 273. For I/Q trace data, the mean of the magnitudes of the I/Q pairs is returned. See “[Mean Value of I/Q Data Pairs for Specified Region\(s\)](#)” on page 273.

Note: If the original trace data is in dB, this function returns the arithmetic mean of those log values, not log of the mean power, which is a more useful value.

Equation 4-1 Mean Value of Data Points for Specified Region(s)

$$\text{MEAN} = \frac{1}{n} \sum_{X_i \in \text{region}(s)} X_i$$

where X_i is a data point value, and n is the number of data points in the specified region(s).

Equation 4-2 Mean Value of I/Q Data Pairs for Specified Region(s)

$$\text{MEAN} = \frac{1}{n} \sum_{X_i \in \text{region}(s)} |X_i|$$

where $|X_i|$ is the magnitude of an I/Q pair, and n is the number of I/Q pairs in the specified region(s).

- **MINimum** - returns the minimum data point for the specified region(s) of trace data. For I/Q trace data, the minimum magnitude of the I/Q pairs is returned.
- **RMS** - returns the arithmetic rms of the data point values for the specified region(s) of trace data. See “[RMS Value of Data Points for Specified Region\(s\)](#)” on page 274.

For I/Q trace data, the rms of the magnitudes of the I/Q pairs is returned. See “[RMS Value of I/Q Data Pairs for Specified Region\(s\)](#)” on page 274.

Note: This function is very useful for I/Q trace data. However, if the original trace data is in dB, this function returns the rms of the log values which is not usually needed.

Equation 4-3 RMS Value of Data Points for Specified Region(s)

$$\text{RMS} = \sqrt{\frac{1}{n} \sum_{X_i \in \text{region}(s)} X_i^2}$$

where X_i is a data point value, and n is the number of data points in the specified region(s).

Equation 4-4 RMS Value of I/Q Data Pairs for Specified Region(s)

$$\text{RMS} = \sqrt{\frac{1}{n} \sum_{X_i \in \text{region}(s)} X_i X_i^*}$$

where X_i is the complex value representation of an I/Q pair, X_i^* its conjugate complex number, and n is the number of I/Q pairs in the specified region(s).

Once you have the rms value for a region of I/Q trace data, you may want to calculate the mean power. You must convert this rms I/Q value (peak volts) to power in dB.

$$10 \times \log[10 \times (\text{rms value})^2]$$

- **SAMPlE** - returns the first data value for the specified region(s) of trace data. For I/Q trace data, the first I/Q pair is returned.
- **SDEViation** - returns the arithmetic standard deviation for the data point values for the specified region(s) of trace data. See “[Standard Deviation of Data Point Values for Specified Region\(s\)](#)” on page 275.

For I/Q trace data, the standard deviation of the magnitudes of the I/Q pairs is returned. See “[Standard Deviation of I/Q Data Pair Values for Specified Region\(s\)](#)” on page 275.

Equation 4-5 Standard Deviation of Data Point Values for Specified Region(s)

$$SDEV = \sqrt{\frac{1}{n} \sum_{X_i \in \text{region}(s)} (X_i - \bar{X})^2}$$

where X_i is a data point value, \bar{X} is the arithmetic mean of the data point values for the specified region(s), and n is the number of data points in the specified region(s).

Equation 4-6 Standard Deviation of I/Q Data Pair Values for Specified Region(s)

$$SDEV = \sqrt{\frac{1}{n} \sum_{X_i \in \text{region}(s)} (|X_i| - \bar{X})^2}$$

where $|X_i|$ is the magnitude of an I/Q pair, \bar{X} is the mean of the magnitudes for the specified region(s), and n is the number of data points in the specified region(s).

- **PPH** - returns the pairs of rms power (dBm) and arithmetic mean phase (radian) for every specified region and frequency offset (Hz). The number of pairs is defined by the specified number of regions. Assuming this command can be used for I/Q vector ($n=0$) in Waveform (time domain) measurement and all parameters are specified by data point in PPH.

The rms power of the specified region may be expressed as:

$$\text{Power} = 10 \times \log [10 \times (\text{RMS I/Q value})] + 10.$$

$$\text{The RMS I/Q value (peak volts)} = \sqrt{\frac{1}{n} \sum_{X_i \in \text{region}} X_i X_i^*}$$

where X_i is the complex value representation of an I/Q pair, X_i^* its

conjugate complex number, and n is the number of I/Q pairs in the specified region.

The arithmetic mean phase of the specified region may be expressed as:

$$\text{Phase} = \frac{1}{n} \sum_{Y_i \in \text{region}} Y_i$$

Where Y_i is the unwrapped phase of I/Q pair with applying frequency correction and n is the number of I/Q pairs in the specified region.

The frequency correction is made by the frequency offset calculated by the arithmetic mean of every specified region's frequency offset. Each frequency offset is calculated by the least square method against the unwrapped phase of I/Q pair.

Figure 4-1 Sample Trace Data - Constant Envelope

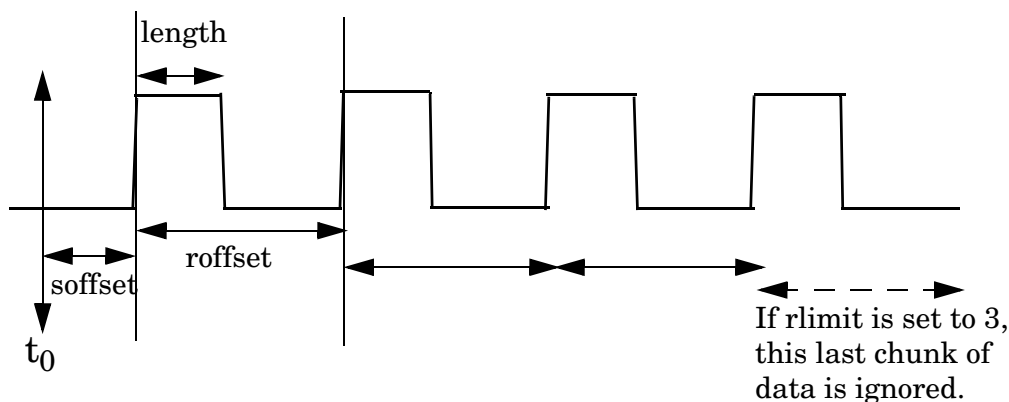
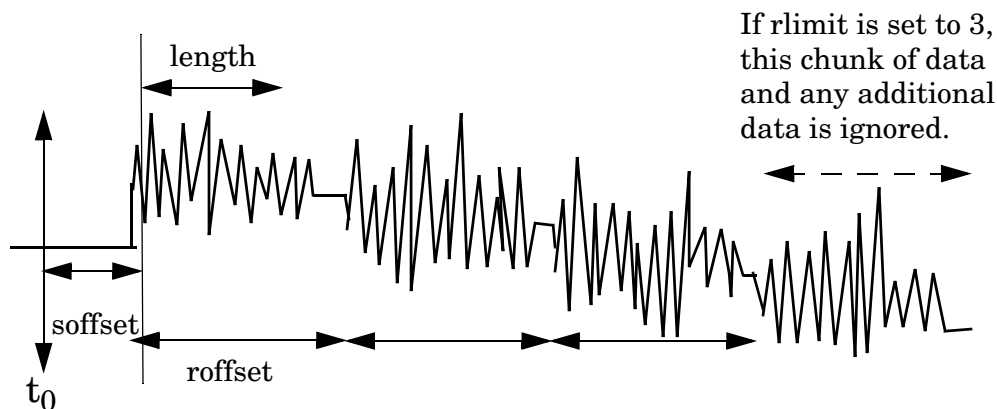

Figure 4-2 Sample Trace Data - Not Constant Envelope



<soffset> - start offset is an optional real number (in seconds). It specifies the amount of data at the beginning of the trace that is ignored before the decimation process starts. It is the time from the start of the trace to the point where you want to start using the data. The default value is zero.

<length> - is an optional real number (in seconds). It defines how much data is compressed into one value. This parameter has a default value equal to the current trace length.

<roffset> - repeat offset is an optional real number (in seconds). It defines the beginning of the next field of trace elements to be compressed. This is relative to the beginning of the previous field. This parameter has a default value equal to the <length> variable.

<rlimit> - repeat limit is an optional integer. It specifies the number of data items that you want returned. It ignores any additional items beyond that number. You can use the Start offset and the Repeat limit to pick out exactly what part of the data you want to use. The default value is all the data.

- Example: To query the mean power of a set of GSM bursts:
1. Set the waveform measurement sweep time to acquire at least one burst.
 2. Set the triggers such that acquisition happens at a known position relative to a burst.
 3. Then query the mean burst levels using, **CALC:DATA2:COMP? MEAN,24e-6,526e-6** (These parameter values correspond to GSM signals, where 526e-6 is the length of the burst in the slot and you just want 1 burst.)

NOTE There is a more detailed example in the “Improving the Speed of Your Measurements” section in the PSA Series *User’s and Programmer’s Reference*. There is also a sample program in the Programming Fundamentals chapter of that book, and a copy of it is on the documentation CD-ROM.

NOTE There is a more detailed example in the “Improving the Speed of Your Measurements” section in the E4406A *Programmer’s Guide*. There is also a sample program in the Programming Fundamentals chapter of that book, and a copy of it is on the documentation CD-ROM.

Remarks: The optional parameters must be entered in the specified order. For example, if you want to specify <length>, you must also specify <soffset>.

This command uses the data in the format specified by FORMat:DATA, returning either binary or ASCII data.

History: Added in revision A.03.00
 Added in revision A.03.00
 Changed in revision A.05.00

| Measurement | Available Traces | Markers Available? |
|--|---|--------------------|
| ACP - adjacent channel power (Basic, cdmaOne, cdma2000, W-CDMA, iDEN, WiDEN, NADC, PDC modes) | no traces $(n=0)^a$ for I/Q points | no markers |
| BER - bit error rate (iDEN, WiDEN mode) | no traces $(n=0)^a$ for I/Q data | no markers |
| CDPower - code domain power (cdmaOne mode) | POWer $(n=2)^a$ TIMing $(n=3)^a$ PHASe $(n=4)^a$ $(n=0)^a$ for I/Q points | yes |
| CDPower - code domain power (cdma2000, W-CDMA modes) | CDPower $(n=2)^a$ EVM $(n=5)^a$ MERRor $(n=6)^a$ PERRor $(n=7)^a$ SPOWer $(n=9)^a$ CPOWer $(n=10)^a$ $(n=0)^a$ for I/Q points | yes |
| CHPower - channel power (Basic, cdmaOne, cdma2000, W-CDMA modes) | SPECtrum $(n=2)^a$ $(n=0)^a$ for I/Q points | no markers |
| CSPur - spurs close (cdmaOne mode) | SPECtrum $(n=2)^a$ ULIMit $(n=3)^a$ $(n=0)^a$ for I/Q points | yes |
| EEVM - EDGE error vector magnitude (EDGE mode) | EVMerror $(n=2)^a$ MERRor $(n=3)^a$ PERRor $(n=4)^a$ $(n=0)^a$ for I/Q points | yes |

| Measurement | Available Traces | Markers Available? |
|---|---|---|
| EORFspectr - EDGE output RF spectrum (EDGE mode) | RFEMod ($n=2$) ^a RFESwitching ($n=3$) ^a SPEMod ($n=4$) ^a LIMMod ($n=5$) ^a ($n=0$) ^a for I/Q points | yes, only for a single offset yes, only for multiple offsets |
| EPVTime - EDGE power versus time (EDGE mode) | RFENvelope ($n=2$) ^a UMASk ($n=3$) ^a LMASk ($n=4$) ^a ($n=0$) ^a for I/Q points | yes |
| ETSPur - EDGE transmit band spurs (EDGE mode) | SPECTrum ($n=2$) ^a ULIMit ($n=3$) ^a ($n=0$) ^a for I/Q points | yes |
| EVM - error vector magnitude (NADC, PDC modes) | EVM ($n=2$) ^a MERRor ($n=3$) ^a PERRor ($n=4$) ^a ($n=0$) ^a for I/Q points | yes |
| EVMQpsk - QPSK error vector magnitude (cdma2000, W-CDMA modes) | EVM ($n=2$) ^a MERRor ($n=3$) ^a PERRor ($n=4$) ^a ($n=0$) ^a for I/Q points | yes |
| IM - intermodulation (cdma2000, W-CDMA modes) | SPECTrum ($n=2$) ^a ($n=0$) ^a for I/Q points | yes |
| MCPower - multi-carrier power (W-CDMA mode) | no traces ($n=0$) ^a for I/Q points | no markers |
| OBW - occupied bandwidth (cdmaOne, cdma2000, iDEN, WiDEN, PDC, W-CDMA modes) | no traces ($n=0$) ^a for I/Q points | no markers |

| Measurement | Available Traces | Markers Available? |
|---|---|---|
| ORFSpectrum - output RF spectrum (GSM, EDGE mode) | RFEMod ($n=2$) ^a RFESwitching ($n=3$) ^a SPEMod ($n=4$) ^a LIMMod ($n=5$) ^a ($n=0$) ^a for I/Q points | yes, only for a single offset yes, only for multiple offsets |
| PFERror - phase and frequency error (GSM, EDGE mode) | PERRor ($n=2$) ^a PFERror ($n=3$) ^a RFENvelope ($n=4$) ^a ($n=0$) ^a for I/Q points | yes |
| PStatistic - power statistics CCDF (Basic, cdma2000, W-CDMA modes) | MEASured ($n=2$) ^a GAUSian ($n=3$) ^a REFerence ($n=4$) ^a ($n=0$) ^a for I/Q points | yes |
| PVTime - power versus time (GSM, EDGE, Service modes) | RFENvelope ($n=2$) ^a UMASk ($n=3$) ^a LMASk ($n=4$) ^a ($n=0$) ^a for I/Q points | yes |
| RHO - modulation quality (cdmaOne, cdma2000, W-CDMA mode) | ($n=0$) ^a for I/Q points EVM ($n=2$) ^a MERRor ($n=3$) ^a PERRor ($n=4$) ^a ($n=0$) ^a for I/Q points | yes |
| SEMask - spectrum emissions mask (cdma2000, W-CDMA mode) | SPECtrum ($n=2$) ^a ($n=0$) ^a for I/Q points | yes |
| TSPur - transmit band spurs (GSM, EDGE mode) | SPECtrum ($n=2$) ^a ULIMit ($n=3$) ^a ($n=0$) ^a for I/Q points | yes |

| Measurement | Available Traces | Markers Available? |
|--|--|--------------------|
| TXPower - transmit power (GSM, EDGE mode) | RFENvelope ($n=2$) ^a IQ ($n=8$) ^a ($n=0$) ^a for I/Q points | yes |
| SPECTrum - (frequency domain) (all modes) | RFENvelope ($n=2$) ^a for Service mode IQ ($n=3$) ^a SPECTrum ($n=4$) ^a ASPECTrum ($n=7$) ^a ($n=0$) ^a for I/Q points | yes |
| WAVEform - (time domain) (all modes) | RFENvelope ($n=2$) ^a (also for Signal Envelope trace) IQ ($n=5$) ^a ($n=0$) ^a for I/Q points | yes |

a. The n number indicates the sub-opcode that corresponds to this trace. Detailed descriptions of the trace data can be found in the MEASure subsystem documentation by looking up the sub-opcode for the appropriate measurement.

Calculate Peaks of Trace Data

:CALCulate:DATA<n>:PEAKs?
<threshold>,<excursion>[,AMPLitude|FREQuency|TIME]

Returns a list of peaks for the designated trace data *n* for the currently selected measurement. The peaks must meet the requirements of the peak threshold and excursion values.

The command can only be used with specific *<n>* (sub-opcode) values, for measurement results that are trace, or scalar, data. See the table above for the appropriate sub-opcodes. Both real and complex traces can be searched, but complex traces are converted to magnitude in dBm. Sub-opcode *n=0*, is the raw trace data which cannot be searched for peaks. Sub-opcode *n=1*, is the scalar data which also cannot be searched for peaks.

Threshold - The level below which trace data peaks are ignored

Excursion - To be defined as a peak, the signal must rise above the threshold by a minimum amplitude change (excursion). Excursion is measured from the lowest point above the threshold (of the rising edge of the peak), to the highest signal point that begins the falling edge. If a signal valley is higher than the threshold, then the excursion is referenced to that valley, and a peak is only defined if the signal following that valley exceeds the excursion.

Amplitude - Lists the peaks in order of descending amplitude, so the highest peak is listed first. This is the default peak order listing if the optional parameter is not specified.

Frequency - Lists the peaks in order of occurrence, left to right across the x-axis

Time - Lists the peaks in order of occurrence, left to right across the x-axis

Example: Select the spectrum measurement.

Use **CALC:DATA4:PEAK? -40,10,FREQ** to identify the peaks above -40 dBm, with excursions of at least 10 dB, in order of increasing frequency.

Query Results: Returns a list of floating-point numbers. The first value in the list is the number of peak points that follow. A peak point consists of two values: a peak amplitude followed by the its corresponding frequency (or time).

If no peaks are found the peak list consists of only the number of peaks, (0).

The peak list is limited to 100 peaks. Peaks in excess of 100 are ignored.

Remarks: This command uses the data setting specified by the

FORMat:DATA command and can return real 32-bit, real 64-bit, or ASCII data. The default data format is ASCII.

History: For E4406A:
Added in revision A.03.00 and later

CALCulate EDGE EVM Subsystem

EDGE EVM–95% tile EVM Limit (Radio Type is BTS, Test Condition is Extreme)

```
:CALCulate:EEVM:LIMit:BTS:EXTReme:EVMP95 <real>
```

```
:CALCulate:EEVM:LIMit:BTS:EXTReme:EVMP95?
```

| | |
|---------------------|--|
| Mode: | GSM |
| Key Path: | Meas Setup, Limit |
| Default Terminator: | percent |
| Factory Preset: | 11.0 percent |
| State Saved: | Saved in instrument state. |
| Range: | 0.0 to 100.0 |
| Min: | 0.0 |
| Max: | 100.0 |
| SCPI Resolution: | 0.1 |
| Notes: | This parameter can only be set using the front panel “Limits” key if the device selected by “Device” key is BTS and “Test Condition” is Extreme. |
| Step: | 1.0 |
| Soft Key Label: | 95% tile EVM |
| Example: | :CALC:EEVM:LIM:BTS:EXTR:EVMP95 15 |

EDGE EVM–Frequency Error Limit (Radio Type is BTS, BTS Type is Normal, Test Condition is Extreme)

```
:CALCulate:EEVM:LIMit:BTS:EXTReme:FERRor <real>
```

```
:CALCulate:EEVM:LIMit:BTS:EXTReme:FERRor?
```

| | |
|-----------------------|--------------------------------------|
| Mode: | GSM |
| Key Path: | Meas Setup, Limit |
| Active Function Text: | Frequency Error |
| SCPI Name: | Frequency Error Limit (BTS, Extreme) |

| | |
|---------------------|--|
| Default Terminator: | Ppm |
| Factory Preset: | 0.05 Ppm |
| State Saved: | Saved in instrument state. |
| Range: | 0.0 to 50.0 |
| Min: | 0.0 |
| Max: | 50.0 |
| SCPI Resolution: | 0.01 |
| Notes: | This parameter can only be set using the front panel “Limits” key if the device selected by “Device” key is BTS and “BTS Type” is Normal or Micro and “Test Condition” is Extreme. |
| RPG: | 0.01 |
| Step: | 0.01 |
| Soft Key Label: | Frequency Error |
| Example: | :CALC:EEVM:LIM:BTS:EXTR:FERR 0.1 |

EDGE EVM–I/Q Origin Offset Limit (Radio Type is BTS, Test Condition is Extreme)

```
:CALCulate:EEVM:LIMit:BTS:EXTReme:IQOOffset <float>
:CALCulate:EEVM:LIMit:BTS:EXTReme:IQOOffset?
```

| | |
|-----------------------|--|
| Mode: | GSM |
| Key Path: | Meas Setup, Limit |
| Active Function Text: | I/Q Origin Offset |
| SCPI Name: | I/Q Origin Offset Limit (BTS, Extreme) |
| Default Terminator: | dBc |
| Factory Preset: | -35.0 dBc |
| State Saved: | Saved in instrument state. |
| Range: | -100.0 to 0.0 |
| Min: | -100.0 |
| Max: | 0.0 |

Programming Commands
CALCulate Subsystem

| | |
|-----------------------------|--|
| SCPI Resolution: | 0.1 |
| Dependencies and Couplings: | N/A |
| Notes: | This parameter can only be set using the front panel “Limits” key if the device selected by “Device” key is BTS and “Test Condition” is Extreme. |
| RPG: | 0.1 |
| Step: | 1.0 |
| Soft Key Label: | I/Q Origin Offset |
| Format (SCPI): | N/A |
| Remote Command Notes: | N/A |
| Example: | :CALC:EEVM:LIM:BTS:EXTR:IQOO -15 |
| History: | Newly added. |

EDGE EVM–Peak EVM Limit (Radio Type is BTS, Test Condition is Extreme)

:CALCulate:EEVM:LIMit:BTS:EXTReme:PEVM <real>

:CALCulate:EEVM:LIMit:BTS:EXTReme:PEVM?

| | |
|-----------------------|--|
| Mode: | GSM |
| Key Path: | Meas Setup, Limit |
| Active Function Text: | Peak EVM |
| Default Terminator: | percent |
| Factory Preset: | 22.0 percent |
| State Saved: | Saved in instrument state. |
| Range: | 0.0 to 100.0 |
| Min: | 0.0 |
| Max: | 100.0 |
| SCPI Resolution: | 0.1 |
| Notes: | This parameter can only be set using the front panel “Limits” key if the device selected by “Device” key is BTS and “Test Condition” is Extreme. |

RPG: 0.1
 Step: 1.0
 Soft Key Label: Peak EVM
 Example: :CALC:EEVM:LIM:BTS:EXTR 15

EDGE EVM–RMS EVM Limit (Radio Type is BTS, Test Condition is Extreme)

:CALCulate:EEVM:LIMit:BTS:EXTReME:REVM <real>
 :CALCulate:EEVM:LIMit:BTS:EXTReME:REVM?

Mode: GSM
 Key Path: **Meas Setup, Limit**
 Active Function Text: RMS EVM
 Default Terminator: percent
 Factory Preset: 8.0 percent
 State Saved: Saved in instrument state.
 Range: 0.0 to 100.0
 Min: 0.0
 Max: 100.0
 SCPI Resolution: 0.1
 Notes: This parameter can only be set using the front panel “Limits” key if the device selected by “Device” key is BTS and “Test Condition” is Extreme.
 RPG: 0.1
 Step: 1.0
 Soft Key Label: RMS EVM
 Example: :CALC:EEVM:LIM:BTS:EXTR:REVM 15

EDGE EVM–95% tile EVM Limit (Radio Type is BTS, Test Condition is Normal)

:CALCulate:EEVM:LIMit:BTS:NORMal:EVMP95 <real>

:CALCulate:EEVM:LIMit:BTS:NORMal:EVMP95?

| | |
|-----------------------|---|
| Mode: | GSM |
| Key Path: | Meas Setup, Limit |
| Active Function Text: | 95% tile EVM |
| Default Terminator: | percent |
| Factory Preset: | 11.0 percent |
| State Saved: | Saved in instrument state. |
| Range: | 0.0 to 100.0 |
| Min: | 0.0 |
| Max: | 100.0 |
| SCPI Resolution: | 0.1 |
| Notes: | This parameter can only be set using the front panel “Limits” key if the device selected by “Device” key is BTS and “Test Condition” is Normal. |
| RPG: | 0.1 |
| Step: | 1.0 |
| Soft Key Label: | 95% tile EVM |
| Example: | :CALC:EEVM:LIM:BTS:NORM:EVMP95 12 |

EDGE EVM–Frequency Error Limit (Radio Type is BTS, BTS Type is Normal, Test Condition is Normal)

:CALCulate:EEVM:LIMit:BTS:NORMal:FERRor <real>

:CALCulate:EEVM:LIMit:BTS:NORMal:FERRor?

| | |
|-----------------------|--------------------------|
| Mode: | GSM |
| Key Path: | Meas Setup, Limit |
| Active Function Text: | Frequency Error |
| Default Terminator: | ppm |
| Factory Preset: | 0.05 ppm |

State Saved: Saved in instrument state.
 Range: 0 to 50.0
 Min: 0.0
 Max: 50.0
 SCPI Resolution: 0.01
 Notes: This parameter can only be set using the front panel “Limits” key if the device selected by “Device” key is BTS and “BTS Type” is Normal or Micro and “Test Condition” is Normal.
 Step: 0.01
 Soft Key Label: Frequency Error
 Example: :CALC:EEVM:LIM:BTS:NORM:FERR 0.1

EDGE EVM–I/Q Origin Offset Limit (Radio Type is BTS, Test Condition is Normal)

:CALCulate:EEVM:LIMit:BTS:NORMal:IQOOffset <float>
 :CALCulate:EEVM:LIMit:BTS:NORMal:IQOOffset?

Mode: GSM
 Key Path: **Meas Setup, Limit**
 Active Function Text: I/Q Origin Offset
 Default Terminator: dBc
 Factory Preset: -35 dBc
 State Saved: Saved in instrument state.
 Range: -100 to 0.0
 Min: -100.0
 Max: 0.0
 SCPI Resolution: 0.1
 Notes: This parameter can only be set using the front panel “Limits” key if the device selected by “Device” key is BTS and “Test Condition” is Normal.
 RPG: 0.1
 Step: 1.0

Soft Key Label: I/Q Origin Offset
Example: :CALC:EEVM:LIM:BTS:NORM:IQOO -12

EDGE EVM–Peak EVM Limit (Radio Type is BTS, Test Condition is Normal)

```
:CALCulate:EEVM:LIMit:BTS:NORMal:PEVM <real>  
:CALCulate:EEVM:LIMit:BTS:NORMal:PEVM?
```

| | |
|-----------------------|---|
| Mode: | GSM |
| Key Path: | Meas Setup, Limit |
| Active Function Text: | Peak EVM |
| Default Terminator: | percent |
| Factory Preset: | 22.0 percent |
| State Saved: | Saved in instrument state. |
| Range: | 0.0 to 100.0 |
| Min: | 0.0 |
| Max: | 100.0 |
| SCPI Resolution: | 0.1 |
| Notes: | This parameter can only be set using the front panel “Limits” key if the device selected by “Device” key is BTS and “Test Condition” is Normal. |
| RPG: | 0.1 |
| Step: | 1.0 |
| Soft Key Label: | Peak EVM |
| Example: | :CALC:EEVM:LIM:BTS:NORM:PEVM 12 |

EDGE EVM–RMS EVM Limit (Radio Type is BTS, Test Condition is Normal)

```
:CALCulate:EEVM:LIMit:BTS:NORMal:REVM <real>  
:CALCulate:EEVM:LIMit:BTS:NORMal:REVM?
```

Mode: GSM

Key Path: **Meas Setup, Limit**

Active Function Text: RMS EVM

Default Terminator: percent

Factory Preset: 7.0 percent

State Saved: Saved in instrument state.

Range: 0.0 to 100.0

Min: 0.0

Max: 100.0

SCPI Resolution: 0.1

Notes: This parameter can only be set using the front panel “Limits” key if the device selected by “Device” key is BTS and “Test Condition” is Normal.

Step: 1.0

Soft Key Label: RMS EVM

Example: :CALC:EEVM:LIM:BTS:NORM:REVM 12

EDGE EVM- 95% tile EVM Limit MS Extreme

```
:CALCulate:EEVM:LIMit:MS:EXTReme:EVMP95 <real>
:CALCulate:EEVM:LIMit:MS:EXTReme:EVMP95?
```

Mode: GSM

Key Path: **Meas Setup, Limit**

Active Function Text: 95% tile EVM

Default Terminator: percent

Factory Preset: 15.0 percent

State Saved: Saved in instrument state.

Range: 0.0 to 100.0 percent

SCPI Resolution: 0.1

Notes: This parameter can only be set using the front panel “Limits” key if the device selected by “Device” key is MS and “Test Condition” is Extreme.

Example: :CALC:EEVM:LIM:MS:EXTR:EVMP95 15

EDGE EVM- Frequency Error Limit MS Extreme

:CALCulate:EEVM:LIMit:MS:EXTReme:FERRor <real>

:CALCulate:EEVM:LIMit:MS:EXTReme:FERRor?

Mode: GSM

Key Path: **Meas Setup, Limit**

Active Function Text: Frequency Error

Default Terminator: Ppm

Factory Preset: 0.1 Ppm

State Saved: Saved in instrument state.

Range: 0.0 to 50.0 Ppm

SCPI Resolution: 0.01

Notes: This parameter can only be set using the front panel “Limits” key if the device selected by “Device” key is MS and “Test Condition” is Extreme.

Example: :CALC:EEVM:LIM:MS:EXTR:FERR 0.2

EDGE EVM- Frequency Error Limit Micro BTS Extreme

:CALCulate:EEVM:LIMit:MBTS:EXTReme:FERRor <real>

:CALCulate:EEVM:LIMit:MBTS:EXTReme:FERRor?

Mode: GSM

Key Path: **Meas Setup, Limit**

Active Function Text: Frequency Error

Default Terminator: ppm

Factory Preset: 0.05 ppm
 State Saved: Saved in instrument state.
 Range: 0.0 to 50.0 ppm
 SCPI Resolution: 0.01
 Notes: This parameter can only be set using the front panel “Limits” key if the device selected by “Device” key is BTS and “BTS Type” is Normal or Micro and “Test Condition” is Extreme.
 Example: :CALC:EEVM:LIM:BTS:EXTR:FERR 0.1

EDGE EVM- Frequency Error Limit Micro BTS Normal

```
:CALCulate:EEVM:LIMit:MBTS:NORMal:FERRor <real>
:CALCulate:EEVM:LIMit:MBTS:NORMal:FERRor?
```

Mode: GSM
 Key Path: **Meas Setup, Limit**
 Active Function Text: Frequency Error
 Default Terminator: ppm
 Factory Preset: 0.05 ppm
 State Saved: Saved in instrument state.
 Range: 0 to 50.0 ppm
 SCPI Resolution: 0.01
 Notes: This parameter can only be set using the front panel “Limits” key if the device selected by “Device” key is BTS and “BTS Type” is Normal or Micro and “Test Condition” is Normal.
 Example: :CALC:EEVM:LIM:BTS:NORM:FERR 0.1

EDGE EVM- I/Q Origin Offset Limit MS Extreme

```
:CALCulate:EEVM:LIMit:MS:EXTReMe:IQOOffset <real>
:CALCulate:EEVM:LIMit:MS:EXTReMe:IQOOffset?
```

Mode: GSM

| | |
|-----------------------|---|
| Key Path: | Meas Setup, Limit |
| Active Function Text: | I/Q Origin Offset |
| Default Terminator: | dBc |
| Factory Preset: | -30.0 dBc |
| State Saved: | Saved in instrument state. |
| Range: | -100.0 to 0.0 dBc |
| SCPI Resolution: | 0.1 |
| Notes: | This parameter can only be set using the front panel “Limits” key if the device selected by “Device” key is MS and “Test Condition” is Extreme. |
| Example: | :CALC:EEVM:LIM:MS:EXTR:IQOO -15 |

EDGE EVM- Peak EVM Limit MS Extreme

```
:CALCulate:EEVM:LIMit:MS:EXTReme:PEVM <real>  
:CALCulate:EEVM:LIMit:MS:EXTReme:PEVM?
```

| | |
|-----------------------|---|
| Mode: | GSM |
| Key Path: | Meas Setup, Limit |
| Active Function Text: | Peak EVM |
| Default Terminator: | percent |
| Factory Preset: | 30.0 percent |
| State Saved: | Saved in instrument state. |
| Range: | 0.0 to 100.0 percent |
| SCPI Resolution: | 0.1 |
| Notes: | This parameter can only be set using the front panel “Limits” key if the device selected by “Device” key is MS and “Test Condition” is Extreme. |
| Example: | :CALC:EEVM:LIM:MS:EXTR:PEVM 15 |

EDGE EVM- RMS EVM Limit MS Extreme

```
:CALCulate:EEVM:LIMit:MS:EXTReMe:REVM <real>
:CALCulate:EEVM:LIMit:MS:EXTReMe:REVM?
```

Mode: GSM

Key Path: **Meas Setup, Limit**

Active Function Text: RMS EVM

Default Terminator: percent

Factory Preset: 10.0 percent

State Saved: Saved in instrument state.

Range: 0.0 to 100.0 percent

SCPI Resolution: 0.1

Notes: This parameter can only be set using the front panel “Limits” key if the device selected by “Device” key is MS and “Test Condition” is Extreme.

Example: :CALC:EEVM:LIM:MS:EXTR:REVM 15

EDGE EVM- 95% tile EVM Limit MS Normal

```
:CALCulate:EEVM:LIMit:MS:NORMal:EVMP95 <real>
:CALCulate:EEVM:LIMit:MS:NORMal:EVMP95?
```

Mode: GSM

Key Path: **Meas Setup, Limit**

Active Function Text: 95% tile EVM

Default Terminator: percent

Factory Preset: 15.0 percent

State Saved: Saved in instrument state.

Range: 0.0 to 100.0 percent

SCPI Resolution: 0.1

Notes: This parameter can only be set using the front panel “Limits” key if the device selected by “Device” key is MS and “Test Condition” is Normal.

Example: :CALC:EEVM:LIM:MS:NORM:EVMP95 20

EDGE EVM- Frequency Error Limit MS Normal

:CALCulate:EEVM:LIMit:MS:NORMal:FERRor <real>

:CALCulate:EEVM:LIMit:MS:NORMal:FERRor?

Mode: GSM

Key Path: **Meas Setup, Limit**

Active Function: Frequency Error

Text:

Default: ppm

Terminator:

Factory Preset: 0.1 ppm

State Saved: Saved in instrument state.

Range: 0 to 50.0 ppm

SCPI Resolution: 0.01

Notes: This parameter can only be set using the front panel “Limits” key if the device selected by “Device” key is MS and “Test Condition” is Normal.

Example: :CALC:EEVM:LIM:MS:NORM:FERR 0.1

EDGE EVM- I/Q Origin Offset Limit MS Normal

:CALCulate:EEVM:LIMit:MS:NORMal:IQOOffset <real>

:CALCulate:EEVM:LIMit:MS:NORMal:IQOOffset?

Mode: GSM

Key Path: **Meas Setup, Limit**

Active Function: I/Q Origin Offset

Text:

Default: dBc

Terminator:

Factory Preset: -30.0 dBc
 State Saved: Saved in instrument state.
 Range: -100.0 to 0.0 dBc
 SCPI Resolution: 0.1
 Notes: This parameter can only be set using the front panel “Limits” key if the device selected by “Device” key is MS and “Test Condition” is Normal.
 Example: :CALC:EEVM:LIM:MS:NORM:IQOO -20

EDGE EVM- Peak EVM Limit MS Normal

:CALCulate:EEVM:LIMit:MS:NORMal:PEVM <real>
 :CALCulate:EEVM:LIMit:MS:NORMal:PEVM?

Mode: GSM
 Key Path: **Meas Setup, Limit**
 Active Function Text: Peak EVM
 Default Terminator: percent
 Factory Preset: 30.0 percent
 State Saved: Saved in instrument state.
 Range: 0.0 to 100.0 percent
 SCPI Resolution: 0.1
 Notes: This parameter can only be set using the front panel “Limits” key if the device selected by “Device” key is MS and “Test Condition” is Normal.
 Example: :CALC:EEVM:LIM:MS:NORM:PEVM 20

EDGE EVM- RMS EVM Limit MS Normal

:CALCulate:EEVM:LIMit:MS:NORMal:REVM <real>
 :CALCulate:EEVM:LIMit:MS:NORMal:REVM?

Mode: GSM

| | |
|-----------------------|--|
| Key Path: | Meas Setup, Limit |
| Active Function Text: | RMS EVM |
| Default Terminator: | percent |
| Factory Preset: | 9.0 percent |
| State Saved: | Saved in instrument state. |
| Range: | 0.0 to 100.0 percent |
| SCPI Resolution: | 0.1 |
| Notes: | This parameter can only be set using the front panel “Limits” key if the device selected by “Device” key is MS and “Test Condition” is Normal. |
| Example: | :CALC:EEVM:LIM:MS:NORM:REVM 20 |

EDGE EVM- Frequency Error Limit Pico BTS Extreme

```
:CALCulate:EEVM:LIMit:PBTS:EXTReMe:FERRor <real>  
:CALCulate:EEVM:LIMit:PBTS:EXTReMe:FERRor?
```

| | |
|-----------------------|---|
| Mode: | GSM |
| Key Path: | Meas Setup, Limit |
| Active Function Text: | Frequency Error |
| Default Terminator: | Ppm |
| Factory Preset: | 0.1 Ppm |
| State Saved: | Saved in instrument state. |
| Range: | 0.0 to 50.0 Ppm |
| SCPI Resolution: | 0.01 |
| Notes: | This parameter can only be set using the front panel “Limits” key if the device selected by “Device” key is BTS and “BTS Type” is Pico and “Test Condition” is Extreme. |
| Example: | :CALC:EEVM:LIM:PBTS:EXTR:FERR 0.2 |

EDGE EVM- Frequency Error Limit Pico BTS Normal

`:CALCulate:EEVM:LIMit:PBTS:NORMal:FERRor <real>`

`:CALCulate:EEVM:LIMit:PBTS:NORMal:FERRor?`

| | |
|-----------------------|--|
| Mode: | GSM |
| Key Path: | Meas Setup, Limit |
| Active Function Text: | Frequency Error |
| Default Terminator: | ppm |
| Factory Preset: | 0.1 ppm |
| State Saved: | Saved in instrument state. |
| Range: | 0 to 50.0 ppm |
| SCPI Resolution: | 0.01 |
| Notes: | This parameter can only be set using the front panel “Limits” key if the device selected by “Device” key is BTS and “BTS Type” is Pico and “Test Condition” is Normal. |
| Example: | <code>:CALC:EEVM:LIM:PBTS:NORM:FERR 0.1</code> |

EDGE TX Band Spur Calculate Commands

EDGE Transmit Band Spurs—Type of Limit Testing

`:CALCulate:ETSPur:LIMit:TEST ABSolute|RELative`

`:CALCulate:ETSPur:LIMit:TEST?`

Select the limit testing to be done using either absolute (dBm) or relative power (dB) limits.

Factory Preset: Absolute

Remarks: You must be in the EDGE (w/GSM) mode to use this command. Use INSTRument:SElect to set the mode.

History: For E4406A:
Version A.05.00 or later

Front Panel

Access: **Meas Setup, More, Limit**

EDGE Transmit Band Spurs—Define Limits

`:CALCulate:ETSPur:LIMit[:UPPer][:DATA] <power>`

`:CALCulate:ETSPur:LIMit[:UPPer][:DATA]?`

Set the value for the test limit. This command does not accept units. Use CALCulate:ETSPur:LIMit:TEST to select the units dBm (absolute) or dB (relative).

Factory Preset: -36

Range: -200 to 100

Remarks: You must be in the EDGE (w/GSM) mode to use this command. Use INSTRument:SElect to set the mode.

History: For E4406A:
Version A.05.00 or later

Front Panel

Access: **Meas Setup, More, Limit**

CALCulate:MARKers Subsystem

Markers can be put on your displayed measurement data to supply information about specific points on the data. Some of the things that markers can be used to measure include: precise frequency at a point, minimum or maximum amplitude, and the difference in amplitude or frequency between two points.

When using the marker commands you must specify the measurement in the SCPI command. We recommend that you use the marker commands only on the current measurement. Many marker commands return invalid results when used on a measurement that is not current. (This is true for commands that do more than simply setting or querying an instrument parameter.) No error is reported for these invalid results.

You must make sure that the measurement is completed before trying to query the marker value. Using the MEASure or READ command, before the marker command, forces the measurement to complete before allowing the next command to be executed.

Each measurement has its own instrument state for marker parameters. Therefore, if you exit the measurement, the marker settings in each measurement are saved and are then recalled when you change back to that measurement.

Basic Mode - <measurement> key words

- ACPr - no markers (E4406A only)
- CHPower - no markers (E4406A only)
- PStatistic - markers available (E4406A only)
- SPECTrum - markers available
- WAVeform - markers available

Service Mode - <measurement> key words

- PVTime - no markers
- SPECTrum - markers available
- WAVeform - markers available

1xEV-DO Mode - <measurement> key words

- CDPower - markers available
- CHPower - no markers
- EVMQpsk - markers available
- IM - markers available
- OBW - no markers
- PStatistic - markers available
- PVTime - markers available
- RHO - markers available
- SEMask - markers available
- SPECTrum - markers available

- WAVeform - markers available

cdmaOne Mode - <measurement> key words

- ACPr - no markers
- CHPower - no markers
- CDPower - markers available
- CSPur - markers available
- RHO - markers available
- SPECTrum - markers available
- WAVeform - markers available

cdma2000 Mode - <measurement> key words

- ACP - no markers
- CDPower - markers available
- CHPower - no markers
- EVMQpsk - markers available
- IM - markers available
- OBW - no markers
- PStatistic - markers available
- RHO - markers available
- SEMask - markers available
- SPECTrum - markers available
- WAVeform - markers available

GSM (with EDGE) Mode - <measurement> key words

- EEVM - markers available
- EORFspectr - markers available
- EPVTime - no markers
- ETSPur - markers available
- ORFSpectrum - markers available
- PFERror - markers available
- PVTime - no markers
- SPECTrum - markers available
- TSPur - markers available
- TXPower - no markers
- WAVeform - markers available

GSM Mode - <measurement> key words

- ORFSpectrum - markers available
- PFERror - markers available
- PVTime - no markers
- SPECTrum - markers available
- TSPur - markers available
- TXPower - no markers
- WAVeform - markers available

iDEN Mode - <measurement> key words

- ACP - no markers
- BER - no markers
- OBW - no markers
- SPECTrum - markers available
- WAVeform - markers available

NADC Mode - <measurement> key words

- ACP - no markers
- EVM - markers available
- SPECTrum - markers available
- WAVeform - markers available

PDC Mode - <measurement> key words

- ACP - no markers
- EVM - markers available
- OBW - no markers
- SPECTrum - markers available
- WAVeform - markers available

W-CDMA Mode - <measurement> key words

- ACP - no markers
- CDPower - markers available
- CHPower - no markers
- EVMQpsk - markers available
- IM - markers available
- MCPower - no markers
- OBW - no markers
- PStatistic - markers available
- PCONtrol - markers available
- PStatistic - markers available
- PVTmask - markers available
- SEMask - markers available
- SPECTrum - markers available
- WAVeform - markers available

MARKer SCPI Example:

Suppose you are using the Spectrum measurement in your measurement personality. To position marker 2 at the maximum peak value of the trace that marker 2 is currently on, the command is:

```
:CALCulate:SPECTrum:MARKer2:MAXimum
```

You must make sure that the measurement is completed before trying to query the marker value. Use the MEASure or READ command before using the marker command. This forces the measurement to complete before allowing the next command to be executed.

Markers All Off on All Traces

:CALCulate:<measurement>:MARKer:AOFF

Turns off all markers on all the traces in the specified measurement.

Example: **CALC:SPEC:MARK:AOFF**

Remarks: The keyword for the current measurement must be specified in the command. (Some examples include: SPECTrum, WAVeform)

Front Panel

Access: **Marker, More, Marker All Off**

Marker Function Result

:CALCulate:<measurement>:MARKer [1] | 2 | 3 | 4:FUNCTION:RESult?

Queries the result of the currently active marker function. The measurement must be completed before querying the marker. A particular measurement may not have all the types of markers available.

The marker must have already been assigned to a trace. Use

:CALCulate:<measurement>:MARKer [1] | 2 | 3 | 4:TRACe to assign a marker to a particular trace.

Example: **CALC:SPEC:MARK:FUNC:RES?**

Remarks: The keyword for the current measurement must be specified in the command. (Some examples include: SPECTrum, WAVeform)

Front Panel

Access: **Marker, Marker Function**

Marker Peak (Maximum) Search

:CALCulate:<measurement>:MARKer [1] | 2 | 3 | 4:MAXimum

Places the selected marker on the highest point on the trace that is assigned to that particular marker number.

The marker must have already been assigned to a trace. Use

:CALCulate:<measurement>:MARKer [1] | 2 | 3 | 4:TRACe to assign a marker to a particular trace.

Example: **CALC:SPEC:MARK1:MAX**

Remarks: The keyword for the current measurement must be

specified in the command. (Some examples include: SPECTrum, WAVeform)

Front Panel
Access: **Search**

Marker Peak (Minimum) Search

:CALCulate:<measurement>:MARKer [1] | 2 | 3 | 4:MINimum

Places the selected marker on the lowest point on the trace that is assigned to that particular marker number.

The marker must have already been assigned to a trace. Use **:CALCulate:<measurement>:MARKer [1] | 2 | 3 | 4:TRACe** to assign a marker to a particular trace.

Example: **CALC:SPEC:MARK2 MIN**

Remarks: The keyword for the current measurement must be specified in the command. (Some examples include: SPECTrum, WAVeform)

Marker Mode

E4406A (all modes):

PSA Series (Basic, cdmaOne, cdma2000, W-CDMA, GSM/EDGE, NADC, PDC modes):

**:CALCulate:<measurement>:MARKer [1] | 2 | 3 | 4:MODE
POSition|DELTA**

PSA Series (Phase Noise mode only):

**:CALCulate:<measurement>:MARKer [1] | 2 | 3 | 4:MODE
POSition|DELTA|RMSDegree|RMSRadian|RFM|RMSJitter|OFF**

:CALCulate:<measurement>:MARKer [1] | 2 | 3 | 4:MODE?

E4406A/PSA: Selects the type of marker to be a normal position-type marker or a delta marker. A specific measurement may not have both types of markers. For example, several measurements only have position markers

PSA Phase Noise Mode: Selects the type of marker to be a normal position-type marker, a delta marker or an RMS measurement marker.

The marker must have already been assigned to a trace. Use **:CALCulate:<measurement>:MARKer [1] | 2 | 3 | 4:TRACe** to assign a marker to a particular trace.

Example: **CALC:SPEC:MARK:MODE DELTA**

Remarks: For the delta mode only markers 1 and 2 are valid.
The keyword for the current measurement must be specified in the command. (Some examples include: SPECTrum, WAVeform)

Front Panel
Access: **Marker, Marker [Delta]**

Marker On/Off

```
:CALCulate:<measurement>:MARKer [1] | 2 | 3 | 4 [:STATe] OFF | ON | 0 | 1  
:CALCulate:<measurement>:MARKer [1] | 2 | 3 | 4 [:STATe] ?
```

Turns the selected marker on or off.

The marker must have already been assigned to a trace. Use
:CALCulate:<measurement>:MARKer [1] | 2 | 3 | 4 :TRACe to assign a marker to a particular trace.

Example: CALC:SPEC:MARK2: on

Remarks: The keyword for the current measurement must be specified in the command. (Some examples include: SPECTrum, AREFERENCE, CFLocation, WAVeform)
The WAVeform measurement only has two markers available.

Front Panel
Access: **Marker, Select then Marker Normal or Marker On Off**

Marker to Trace

```
:CALCulate:<measurement>:MARKer [1] | 2 | 3 | 4 :TRACe <trace_name>  
:CALCulate:<measurement>:MARKer [1] | 2 | 3 | 4 :TRACe ?
```

Assigns the specified marker to the designated trace. Not all types of measurement data can have markers assigned to them.

Example: With the WAVeform measurement selected, a valid command is CALC:SPEC:MARK2:TRACE rfenvelope.

Range: The names of valid traces are dependent upon the selected measurement. See the following table for the available trace names. The trace name assignment is independent of the marker number.

Remarks: The keyword for the current measurement must be specified in the command. (Some examples include: SPECTrum, WAVeform)

Front Panel
Access: **Marker, Marker Trace**

| Measurement | Available Traces | Markers Available? |
|--|---|--------------------|
| ACP - adjacent channel power (Basic, cdmaOne, cdma2000, W-CDMA, iDEN (E4406A only), WiDEN (E4406A only), NADC, PDC modes) | no traces $(n=0)^a$ for I/Q points | no markers |
| BER - bit error rate (iDEN, WiDEN mode, E4406A only) | no traces $(n=0)^a$ for I/Q data | no markers |
| CDPower - code domain power (cdmaOne mode) | POWER $(n=2)^a$ TIMing $(n=3)^a$ PHASe $(n=4)^a$ $(n=0)^a$ for I/Q points | yes |
| CDPower - code domain power (cdma2000, W-CDMA, 1xEV-DO modes) | CDPower $(n=2)^a$ EVM $(n=5)^a$ MERRor $(n=6)^a$ PERRor $(n=7)^a$ SPOWER $(n=9)^a$ CPOWER $(n=10)^a$ $(n=0)^a$ for I/Q points | yes |
| CHPower - channel power (Basic, cdmaOne, cdma2000, W-CDMA, 1xEV-DO modes) | SPECTrum $(n=2)^a$ $(n=0)^a$ for I/Q points | no markers |
| CSPur - spurs close (cdmaOne mode) | SPECTrum $(n=2)^a$ ULIMit $(n=3)^a$ $(n=0)^a$ for I/Q points | yes |
| EEVM - EDGE error vector magnitude (EDGE mode) | EVMError $(n=2)^a$ MERRor $(n=3)^a$ PERRor $(n=4)^a$ $(n=0)^a$ for I/Q points | yes |

| Measurement | Available Traces | Markers Available? |
|--|---|---|
| EORF _{spectr} - EDGE output RF spectrum (EDGE mode) | RFEMod ($n=2$) ^a RFESwitching ($n=3$) ^a SPEMod ($n=4$) ^a LIMMod ($n=5$) ^a ($n=0$) ^a for I/Q points | yes, only for a single offset yes, only for multiple offsets |
| EPVTime - EDGE power versus time (EDGE mode) | RFENvelope ($n=2$) ^a UMASk ($n=3$) ^a LMASk ($n=4$) ^a ($n=0$) ^a for I/Q points | yes |
| ETSPur - EDGE transmit band spurs (EDGE mode) | SPECtrum ($n=2$) ^a ULIMit ($n=3$) ^a ($n=0$) ^a for I/Q points | yes |
| EVM - error vector magnitude (NADC, PDC modes) | EVM ($n=2$) ^a MERRor ($n=3$) ^a PERRor ($n=4$) ^a ($n=0$) ^a for I/Q points | yes |
| EVMQpsk - QPSK error vector magnitude (cdma2000, W-CDMA, 1xEV-DO modes) | EVM ($n=2$) ^a MERRor ($n=3$) ^a PERRor ($n=4$) ^a ($n=0$) ^a for I/Q points | yes |
| IM - intermodulation (cdma2000, W-CDMA, 1xEV-DO modes) | SPECtrum ($n=2$) ^a ($n=0$) ^a for I/Q points | yes |
| MCPower - multi-carrier power (W-CDMA mode) | no traces ($n=0$) ^a for I/Q points | no markers |
| OBW - occupied bandwidth (cdmaOne, cdma2000, iDEN (E4406A only), WiDEN (E4406A only), PDC, W-CDMA, 1xEV-DO modes) | no traces ($n=0$) ^a for I/Q points | no markers |

| Measurement | Available Traces | Markers Available? |
|---|---|---|
| ORFSpectrum - output RF spectrum (GSM, EDGE mode) | RFEMod ($n=2$) ^a RFESwitching ($n=3$) ^a SPEMod ($n=4$) ^a LIMMod ($n=5$) ^a ($n=0$) ^a for I/Q points | yes, only for a single offset yes, only for multiple offsets |
| PFERror - phase and frequency error (GSM, EDGE mode) | PERRor ($n=2$) ^a PFERror ($n=3$) ^a RFENvelope ($n=4$) ^a ($n=0$) ^a for I/Q points | yes |
| PStatistic - power statistics CCDF (Basic, cdma2000, W-CDMA, 1xEV-DO modes) | MEASured ($n=2$) ^a GAUSSian ($n=3$) ^a REFerence ($n=4$) ^a ($n=0$) ^a for I/Q points | yes |
| PVTime - power versus time (GSM, EDGE, 1xEV-DO, Service (E4406A only) modes) | RFENvelope ($n=2$) ^a UMASk ($n=3$) ^a LMASk ($n=4$) ^a ($n=0$) ^a for I/Q points | yes |
| RHO - modulation quality (cdmaOne, cdma2000, W-CDMA, 1xEV-DO mode) | ($n=0$) ^a for I/Q points EVM ($n=2$) ^a MERRor ($n=3$) ^a PERRor ($n=4$) ^a ($n=0$) ^a for I/Q points | yes |
| SEMask - spectrum emissions mask (cdma2000, W-CDMA, 1xEV-DO mode) | SPECTrum ($n=2$) ^a ($n=0$) ^a for I/Q points | yes |
| TSPur - transmit band spurs (GSM, EDGE mode) | SPECTrum ($n=2$) ^a ULIMit ($n=3$) ^a ($n=0$) ^a for I/Q points | yes |

| Measurement | Available Traces | Markers Available? |
|--|---|--------------------|
| TXPower - transmit power (GSM, EDGE mode) | RFENvelope ($n=2$) ^a IQ ($n=8$) ^a ($n=0$) ^a for I/Q points | yes |
| SPECtrum - (frequency domain) (all modes) | RFENvelope ($n=2$) ^a for Service mode (E4406A only) IQ ($n=3$) ^a SPECtrum ($n=4$) ^a ASPECTrum ($n=7$) ^a ($n=0$) ^a for I/Q points | yes |
| WAVEform - (time domain) (all modes) | RFENvelope ($n=2$) ^a (also for Signal Envelope trace) IQ ($n=5$) ^a ($n=0$) ^a for I/Q points | yes |

a. The n number indicates the sub-opcode that corresponds to this trace. Detailed descriptions of the trace data can be found in the MEASure subsystem documentation by looking up the sub-opcode for the appropriate measurement.

Marker X Value

:CALCulate:<measurement>:MARKer [1] | 2 | 3 | 4 :X <param>

:CALCulate:<measurement>:MARKer [1] | 2 | 3 | 4 :X?

Position the designated marker on its assigned trace at the specified X value. The parameter value is in X-axis units (which is often frequency or time).

The marker must have already been assigned to a trace. Use **:CALCulate:<measurement>:MARKer [1] | 2 | 3 | 4 :TRACe** to assign a marker to a particular trace.

The query returns the current X value of the designated marker. The measurement must be completed before querying the marker.

Example: **CALC:SPEC:MARK2:X 1.2e6 Hz**

Range: For Phase Noise mode: Graph Start Offset and Stop

Offset frequencies.

Default Unit: Matches the units of the trace on which the marker is positioned

Remarks: The keyword for the current measurement must be specified in the command. (Some examples include: LPLot, ACP, CFLocation, WAVeform)

Front Panel

Access: **Marker, <active marker>, RPG**

Marker X Position

:CALCulate:<measurement>:MARKer [1] | 2 | 3 | 4:X:POSition <integer>

:CALCulate:<measurement>:MARKer [1] | 2 | 3 | 4:X:POSition?

Position the designated marker on its assigned trace at the specified X position. A trace is composed of a variable number of measurement points. This number changes depending on the current measurement conditions. The current number of points must be identified before using this command to place the marker at a specific location.

The marker must have already been assigned to a trace. Use **:CALCulate:<measurement>:MARKer [1] | 2 | 3 | 4:TRACe** to assign a marker to a particular trace.

The query returns the current X position for the designated marker. The measurement must be completed before querying the marker.

Example: **CALC:SPEC:MARK:X:POS 500**

Range: 0 to a maximum of (3 to 920,000)

Remarks: The keyword for the current measurement must be specified in the command. (Some examples include: SPECTrum, WAVeform)

Front Panel

Access: **Marker, <active marker>, RPG**

Marker Readout Y Value

:CALCulate:<measurement>:MARKer [1] | 2 | 3 | 4:Y?

Readout the current Y value for the designated marker on its assigned trace. The value is in the Y-axis units for the trace (which is often dBm).

The marker must have already been assigned to a trace. Use **:CALCulate:<measurement>:MARKer [1] | 2 | 3 | 4:TRACe** to assign a marker to a particular trace.

The measurement must be completed before querying the marker.

Example: **CALC:SPEC:MARK1:Y?**

Default Unit: Matches the units of the trace on which the marker is positioned

Remarks: The keyword for the current measurement must be specified in the command. (Some examples include: LPLot, ACP, CFLocation, WAVEform)

CALCulate Phase and Frequency Error Subsystem

Phase and Frequency Error- RMS Phase Error BTS

:CALCulate:PFER:LIMit:BTS:FERRor <real>

:CALCulate:PFER:LIMit:BTS:FERRor?

Mode: **GSM**

Key Path: **Meas Setup, Limit**

Active Function **Freq Error**
Text:

Default **ppm**
Terminator:

Factory Preset: **0.05 ppm**

State Saved: **Saved in instrument state.**

Range: **0.0 to 50.0 ppm**

SCPI Resolution: **0.01**

Notes: This parameter can only be set using the front panel “Limits” key if the device selected by “Device” key is BTS and “BTS Type” is Normal or Micro.

Example: **:CALC:PFER:LIM:BTS:FERR 0.1**

Phase and Frequency Error- Peak Phase Error BTS

:CALCulate:PFER:LIMit:BTS:PPHase <degree>

:CALCulate:PFER:LIMit:BTS:PPHase?

Mode: **GSM**

Key Path: **Meas Setup, Limit**

| | |
|-----------------------|--|
| Active Function Text: | Peak Phase Error |
| Default Terminator: | degree |
| Factory Preset: | 20.0 degree |
| State Saved: | Saved in instrument state. |
| Range: | 0.0 to 180.0 degree |
| SCPI Resolution: | 0.1 |
| Notes: | This parameter can only be set using the front panel “Limits” key if the device selected by “Device” key is BTS. |
| Example: | :CALC:PFER:LIM:BTS:PPH 30 |

Phase and Frequency Error- RMS Phase Error BTS

```
:CALCulate:PFER:LIMit:BTS:RPHase <degree>
:CALCulate:PFER:LIMit:BTS:RPHase?
```

| | |
|-----------------------|--|
| Mode: | GSM |
| Key Path: | Meas Setup, Limit |
| Active Function Text: | RMS Phase Error |
| Default Terminator: | degree |
| Factory Preset: | 5.0 degree |
| State Saved: | Saved in instrument state. |
| Range: | 0.0 to 180.0 degree |
| SCPI Resolution: | 0.1 |
| Notes: | This parameter can only be set using the front panel “Limits” key if the device selected by “Device” key is BTS. |
| Example: | :CALC:PFER:LIM:BTS:RPH 10 |

Phase and Frequency Error- RMS Phase Error Micro BTS

```
:CALCulate:PFER:LIMit:MBTS:FERRor <real>
```

:CALCulate:PFER:LIMit:MBTS:FERRor?

| | |
|--------------------------|--|
| Mode: | GSM |
| Key Path: | Meas Setup, Limit |
| Active Function Text: | Freq Error |
| Default Terminator: | ppm |
| Factory Preset: | 0.05 ppm |
| State Saved: | Saved in instrument state. |
| Range: | 0.0 to 50.0 ppm |
| SCPI Resolution: | 0.01 |
| Notes: | This parameter can only be set using the front panel “Limits” key if the device selected by “Device” key is BTS and “BTS Type” is Normal or Micro. |
| Example: | :CALC:PFER:LIM:MBTS:FERR 0.1 |

Phase and Frequency Error- RMS Phase Error MS

:CALCulate:PFER:LIMit:MS:FERRor <real>

:CALCulate:PFER:LIMit:MS:FERRor?

| | |
|--------------------------|---|
| Mode: | GSM |
| Key Path: | Meas Setup, Limit |
| Active Function Text: | Freq Error |
| Default Terminator: | ppm |
| Factory Preset: | 0.1 ppm |
| State Saved: | Saved in instrument state. |
| Range: | 0.0 to 50.0 ppm |
| SCPI Resolution: | 0.01 |
| Notes: | This parameter can only be set using the front panel “Limits” key if the device selected by “Device” key is MS. |
| Example: | :CALC:PFER:LIM:MS:FERR 0.1 |

Phase and Frequency Error- Peak Phase Error MS

:CALCulate:PFER:LIMit:MS:PPHase <degree>

:CALCulate:PFER:LIMit:MS:PPHase?

| | |
|-----------------------|---|
| Mode: | GSM |
| Key Path: | Meas Setup, Limit |
| Active Function Text: | Peak Phase Error |
| Default Terminator: | degree |
| Factory Preset: | 20.0 degree |
| State Saved: | Saved in instrument state. |
| Range: | 0.0 to 180.0 degree |
| SCPI Resolution: | 0.1 |
| Notes: | This parameter can only be set using the front panel “Limits” key if the device selected by “Device” key is MS. |
| Example: | :CALC:PFER:LIM:MS:PPH 10 |

Phase and Frequency Error- RMS Phase Error MS

:CALCulate:PFER:LIMit:MS:RPHase <degree>

:CALCulate:PFER:LIMit:MS:RPHase?

| | |
|-----------------------|----------------------------|
| Mode: | GSM |
| Key Path: | Meas Setup, Limit |
| Active Function Text: | RMS Phase Error |
| Default Terminator: | degree |
| Factory Preset: | 5.0 degree |
| State Saved: | Saved in instrument state. |
| Range: | 0.0 to 180.0 degree |

SCPI Resolution: 0.1

Notes: This parameter can only be set using the front panel “Limits” key if the device selected by “Device” key is MS.

Example: :CALC:PFER:LIM:MS:RPH 10

Phase and Frequency Error- RMS Phase Error Pico BTS

:CALCulate:PFER:LIMit:PBTS:FERRor <real>

:CALCulate:PFER:LIMit:PBTS:FERRor?

Mode: GSM

Key Path: **Meas Setup, Limit**

Active Function: Freq Error

Text:

Default Terminator: ppm

Factory Preset: 0.1 ppm

State Saved: Saved in instrument state.

Range: 0.0 to 50.0 ppm

SCPI Resolution: 0.01

Notes: This parameter can only be set using the front panel “Limits” key if the device selected by “Device” key is BTS and “BTS Type” is Pico.

Example: :CALC:PFER:LIM:PBTS:FERR 0.1

Baseband I/Q - Spectrum I/Q Marker Query

:CALCulate:SPECTrum:MARKer [1] | 2 | 3 | 4 :IQ?

Reads out current I and Q marker values.

Remarks: You must be in the Basic, W-CDMA, cdma2000, or EDGE with GSM mode to use this command. Use INSTRument:SElect to set the mode.

History: Added revision A.05.00 for B, WC, C2
Added revision A.06.00 for E

Transmit Band Spurious - Limits

Transmit Band Spurs—Type of Limit Testing

```
:CALCulate:TSPur:LIMit:TEST ABSolute|RELative
```

```
:CALCulate:TSPur:LIMit:TEST?
```

Select the limit testing to be done using either absolute or relative power limits.

Factory Preset: Absolute

Remarks: You must be in the GSM, EDGE (w/GSM) mode to use this command. Use INSTRUMENT:SELEct to set the mode.

History: Version A.03.00 or later

Front Panel

Access: **Meas Setup, Limit**

Transmit Band Spurs—Define Limits

```
:CALCulate:TSPur:LIMit[:UPPer][:DATA] <power>
```

```
:CALCulate:TSPur:LIMit[:UPPer][:DATA]?
```

Set the value for the test limit. This command does not accept units. Use CALCulate:TSPur:LIMit:TEST to select the units dBm (absolute) or dB (relative).

Factory Preset: -36

Range: -200 to 100

Remarks: You must be in the GSM, EDGE (w/GSM) mode to use this command. Use INSTRUMENT:SELEct to set the mode.

History: Version A.03.00 or later

Front Panel

Access: **Meas Setup, Limit**

Baseband I/Q - Waveform I/Q Marker Query

```
:CALCulate:WAVEform:MARKer[1]|2|3|4:IQ?
```

Reads out current I and Q marker values.

Remarks: You must be in the Basic, W-CDMA, cdma2000, or GSM with EDGE mode to use this command. Use INSTRUMENT:SELEct to set the mode.

Programming Commands
CALCulate Subsystem

History: Added revision A.05.00 for B, WC, C2
 Added revision A.06.00 for E

CONFigure Subsystem

The CONFigure commands are used with several other commands to control the measurement process. The full set of commands are described in the section “[MEASure Group of Commands](#)” on page 347.

Selecting measurements with the CONFigure/FETCh/MEASure/READ commands sets the instrument state to the defaults for that measurement and to make a single measurement. Other commands are available for each measurement to allow you to change: settings, view, limits, etc. Refer to:

SENSe:<measurement>, SENSe:CHANnel, SENSe:CORRection,
 SENSe:DEFaults, SENSe:DEViation, SENSe:FREQuency,
 SENSe:PACKet, SENSe:POWer, SENSe:RADio, SENSe:SYNC
 CALCulate:<measurement>, CALCulate:CLIMits
 DISPlay:<measurement>
 TRIGger

The INITiate[:IMMediate] or INITiate:REStart commands initiate the taking of measurement data without resetting any of the measurement settings that you have changed from their defaults.

Configure the Selected Measurement

:CONFigure:<measurement>

A CONFigure command must specify the desired measurement. It sets the instrument settings for that measurement’s standard defaults, but should not initiate the taking of data. The available measurements are described in the MEASure subsystem.

NOTE

If CONFigure initiates the taking of data, the data should be ignored. Other SCPI commands can be processed immediately after sending CONFigure. You do not need to wait for the CONF command to complete this 'false' data acquisition.

Configure Query

:CONFigure?

The CONFigure query returns the name of the current measurement.

DISPlay Subsystem

The DISPlay controls the selection and presentation of textual, graphical, and TRACe information. Within a DISPlay, information may be separated into individual WINDows.

Adjacent Channel Power - View Selection

```
:DISPlay:ACP:VIEW BGRaph|SPECTrum
```

```
:DISPlay:ACP:VIEW?
```

Select the adjacent channel power measurement display of bar graph or spectrum.

You may want to disable the spectrum trace data part of the measurement so you can increase the speed of the rest of the measurement display. Use SENSE:ACP:SPECTrum:ENABLE to turn on or off the spectrum trace. (Basic and cdmaOne modes only)

Factory Preset: Bar Graph (BGRaph)

Remarks: For E4406A you must be in the Basic, cdmaOne, cdma2000, W-CDMA, NADC or PDC mode to use this command. Use INSTRument:SElect to set the mode.

For PSA you must be in the cdmaOne, cdma2000, W-CDMA, NADC or PDC mode to use this command. Use INSTRument:SElect to set the mode.

Front Panel

Access: **ACP, View/Trace**

Turn the Display On/Off

```
:DISPlay:ENABLE OFF|ON|0|1
```

```
:DISPlay:ENABLE?
```

Controls the display. If enable is set to off, the display is turned off. For E4406A, if enable is set to off, the display appears to “freeze” in its current state. Measurements may run faster since the instrument doesn’t have to update the display after every data acquisition. There is often no need to update the display information when using remote operation. Turning the display off also extends its life and reduces EMI. An instrument preset turns the display back on.

Factory Preset: On

Remarks: The following key presses turn display enable back on:

1. If in local, press any key
2. If in remote, press the local (system) key
3. If in local lockout (SYST:KLOCK), no key press works

Front Panel

Access

(for E4406A): **System, Disp Updates**

EDGE PVT - Limit Mask On/Off

```
:DISPlay:EPVTime:LIMit:MASK OFF|ON|0|1
```

```
:DISPlay:EPVTime:LIMit:MASK?
```

Turns on/off the display of the limit mask lines. It also disables the limit checking.

Factory Preset: On

Remarks: You must be in EDGE (w/GSM) to use this command.
 Use INSTRument:SElect to set the mode.

Front Panel

Access: **Display**, with EPVT measurement selected

EDGE PVT - View Selection (PSA Only)

```
:DISPlay:EPVT:VIEW[:SElect] ALL|BOTH|MSLot
```

```
:DISPlay:EPVT:VIEW[:SElect]?
```

The **Trace/View** key accesses a menu that allows you to select the desired view of the measurement from the following three selections:

- **Burst** - views the entire burst of interest as determined by the current trigger source, burst sync, training sequence, and timeslot settings. To view a different burst of interest you must set these parameters for the selected timeslot. To view multiple slots use the **Multi-Slot** key described below (SCPI:ALL).
- **Rise & Fall** - zooms in on the rising and falling portions of the burst being tested (SCPI:BOTH).
- **Multi-Slot** -views the entire sweep as specified by the current Meas Time setting. Power levels for each active slot are listed in the table below the timeslot display. Also shown in the table under “1st Error Pt.” is the point in time at which the signal level first exceeds the

limit, which helps to identify the slot where a failure first occurs (SCPI:MSLot).

State Saved: Saved in instrument state.

Factory

Preset: ALL

Range: Burst | Rise & Fall | Multi-Slot

Front Panel

Access: **Trace/View**

Example: :DISPlay:EPVTime:VIEW:SEL ALL

History: A.09.15 or later

EDGE Output RF Spectrum - View Selection (PSA Only)

:DISPlay:EORFspectr:VIEW[:SElect] MPOWer | MLIMit | SLIMit

:DISPlay:EORFspectr:VIEW[:SElect] ?

Allows you to select one of the following four views:

- Modulation Power - When Meas Method is set to Multi-Offset, and Meas Type is set to Modulation, or Mod and Switch, measurement results may be viewed as absolute and relative to the reference power in tabular form.(SCPI:MPOWer).
- Modulation Margin & Limits- When Meas Method is set to Multi-Offset, and Meas Type is set to Modulation, or Mod and Switch, relative and absolute limits and measurement results may be viewed as relative power to the limit in tabular form. (SCPI:MLIMit).
- Switching Power - When Meas Method is set to Multi-Offset, and Meas Type is set to Switching, or Mod and Switch, measurement results may be viewed as absolute and relative to the reference power in tabular form.(SCPI:SPOWer).
- Switching Margin & Limits - When Meas Method is set to Multi-Offset, and Meas Type is set to Switching, or Mod and Switch, relative and absolute limits and measurement results may be viewed as relative power to the limit in tabular form.(SCPI:SLIMit).

State Saved: Saved in instrument state.

Factory

Preset: MPOWer

Range: Modulation Power | Modulation Margin & Limits | Switching Power | Switching Margin & Limits

Front Panel

Access: **Trace/View**

Example: DISPlay:ORFS:VIEW:SEL MPOW

Notes: If the Meas Method is Multi-Offset and the Meas Type is Mod & Switch, pressing the View/Trace key allows you to select the desired view for the current measurement.

If the Meas Type is Modulation, keys for Switching disappear.

If the Meas Type is Switching, keys for Modulation disappear.

If the Meas Method is other than Multi-Offset, all selections disappear.

If the view specified by the parameter doesn't exist, the parameter issued is ignored.

If the Meas Type is changed, the default view (the top of the softkey selection) is automatically selected.

You must be in the GSM mode to use this command. Use INSTRument:SElect to set the mode.

History: A.09.15 or later

EDGE EVM - View Selection (PSA Only)

:DISPlay:EEVM:VIEW[:SElect] POLar | CONSTln | QUAD | DBITS

:DISPlay:EEVM:VIEW[:SElect] ?

The **View/Trace** key allows you to select the desired view of the measurement from the following views:

Polar Vector - Provides a view of numeric results and a polar vector graph.(SCPI:POLar).

- Window 1: Numeric Results
- Window 2: Polar Vector Graph

Polar Constln - Provides a view of numeric results and a polar constellation graph (SCPI:CONSTln).

- Window 1: Numeric Results
- Window 2: Polar Constellation Graph

I/Q Error (Quad-View) - Provides a combination view that includes the following windows (SCPI:QUAD)

- Window 1: Magnitude Error

- Window 2: Phase Error
- Window 3: EVM
- Window 4: Numeric Results with demodulated bits

You can select any of these windows, by using the Next Window key, and make it full size, by using the Zoom key

Data Bits - Provides a view of the numeric results and data bits with the sync word (TSC) highlighted (SCPI:DBITs).

State Saved: Saved in instrument state.

Factory

Preset: POLar

Range: Polar Vector | Polar Constln | I/Q
Error\n(Quad-View) | Data Bits

Front Panel

Access: **Trace/View**

Example: :DISP:EEVM:VIEW:SEL QUAD
:DISP:EEVM:VIEW:SEL?

Notes: You must be in the GSM mode to use this command.
Use INSTRument:SElect to set the mode.

History: A.09.15 or later

GMSK PVT - View Selection (PSA Only)

```
:DISPlay:PVT:VIEW[:SElect] ALL|BOTH|MSLot
```

```
:DISPlay:PVT:VIEW[:SElect] ?
```

The **Trace/View** key accesses a menu that allows you to select the desired view of the measurement from the following three selections:

- **Burst** - Views the entire burst of interest as determined by the current trigger source, burst sync, training sequence, and timeslot settings. To view a different burst of interest you must set these parameters for the selected timeslot. To view multiple slots use the **Multi-Slot** key described below (SCPI:ALL).
- **Rise & Fall** - Zooms in on the rising and falling portions of the burst being tested (SCPI:BOTH).
- **Multi-Slot** -Views the entire sweep as specified by the current Meas Time setting. Power levels for each active slot are listed in the table below the timeslot display. Also shown in the table under “1st Error Pt.” is the point in time at which the signal level first exceeds the limit, which helps to identify the slot where a failure first occurs (SCPI:MSLot).

State Saved: Saved in instrument state.
 Factory
 Preset: ALL
 Range: Burst | Rise & Fall | Multi-Slot
 Front Panel
 Access: **Trace/View**
 Example: :DISPlay:PVTime:VIEW:SEL ALL
 History: A.09.15 or later

GMSK Output RF Spectrum - View Selection (PSA Only)

```
:DISPlay:ORFspectrum:VIEW[:SELEct] MPOWer|MLIMit|SLIMit
:DISPlay:ORFspectrum:VIEW[:SELEct] ?
```

Allows you to select one of the following four views:

- Modulation Power -When Meas Method is set to Multi-Offset, and Meas Type is set to Modulation, or Mod and Switch, measurement results may be viewed as absolute and relative to the reference power in tabular form.(SCPI:MPOWer).
- Modulation Margin & Limits- When Meas Method is set to Multi-Offset, and Meas Type is set to Modulation, or Mod and Switch, measurement results may be viewed as absolute and relative power to the reference power in tabular form. (SPOWer in SCPI).
- Switching Power - When Meas Method is set to Multi-Offset, and Meas Type is set to Switching, or Mod and Switch, relative and absolute limits and measurement results may be viewed as relative power to the limit in tabular form.(SCPI:MLIMit).
- Switching Margin & Limits - When Meas Method is set to Multi-Offset, and Meas Type is set to Switching, or Mod and Switch, relative and absolute limits and measurement results may be viewed as relative power to the limit in tabular form.(SCPI:SPOWer).

State Saved: Saved in instrument state.
 Factory
 Preset: MPOWer
 Range: Modulation Power | Modulation Margin & Limits | Switching Power | Switching Margin & Limits
 Front Panel
 Access: **Trace/View**

Example: :DISP:ORFS:VIEW:SEL MPOW

Notes: If the Meas Method is Multi-Offset and the Meas Type is Mod & Switch, pressing the View/Trace key allows you to select the desired view for the current measurement.

If the Meas Type is Modulation, keys for Switching disappear.

If the Meas Type is Switching, keys for Modulation disappear.

If the Meas Method is other than Multi-Offset, all selections disappear.

If the view specified by the parameter doesn't exist, the parameter issued is ignored.

If the Meas Type is changed, the default view (the top of the softkey selection) is automatically selected.

You must be in the GSM mode to use this command. Use INSTRUMENT:SElect to set the mode.

History: A.09.15 or later

GMSK Phase & Frequency - View Selection (PSA Only)

:DISPlay:PFError:VIEW[:SElect] QUAD|POLar|DBITs

:DISPlay:PFError:VIEW[:SElect] ?

The **View/Trace** key allows you to select to select the desired view of the measurement from the following views:

I/Q Error (Quad-View) - Provides a combination view that includes the following windows (SCPI:QUAD)

- Window 1: Phase Error
- Window 2: Phase Error with Frequency
- Window 3: RF Envelope
- Window 4: Numeric Results and demodulated bits

You can select any of these windows by using the Next Window key, and make it full size, by using the Zoom key

Polar Vector - Provides a view of numeric results and a polar vector graph.(SCPI:POLar).

- Window 1: Numeric Results
- Window 2: Polar Vector Graph

Data Bits - Provides a view of the numeric results and data bits with the sync word (TSC) highlighted (SCPI:DBITs).

State Saved: Saved in instrument state.

Factory

Preset: QUAD

Range: I/Q Error\n(Quad-View) | I/Q Measured\nPolar Vector | Data Bits

Front Panel

Access: **Trace/View**

Example: :DISP:PFER:VIEW:SEL QUAD

Notes: You must be in the GSM mode to use this command.
 Use INSTRUMENT:SElect to set the mode.

History: A.09.15 or later

Select Display Format

:DISPlay:FORMat:TILE

Selects the viewing format that displays multiple windows of the current measurement data simultaneously. Use DISP:FORM:ZOOM to return the display to a single window.

Remarks: For PSA you must be in the Basic, cdmaOne,cdma2000, 1xEV-DO, W-CDMA, GSM (w/EDGE), NADC, or PDC mode to use this command. Use INSTRUMENT:SElect to set the mode

Front Panel

Access: **Zoom** (toggles between Tile and Zoom)

Select Display Format

:DISPlay:FORMat:ZOOM

Selects the viewing format that displays only one window of the current measurement data (the current active window). Use DISP:FORM:TILE to return the display to multiple windows.

Remarks: For PSA you must be in the Basic, cdmaOne,cdma2000, 1xEV-DO, W-CDMA, GSM (w/EDGE), NADC, or PDC mode to use this command. Use INSTRUMENT:SElect to set the mode

Front Panel

Access: **Zoom** (toggles between Tile and Zoom)

Full Screen Display (PSA Only)

`:DISPlay:FSCReen[:STATe] OFF|ON|0|1`

`:DISPlay:FSCReen[:STATe]?`

For Noise Figure Mode only:

`:DISPlay:FSCREEN|FULLSCREEN[:STATe] ON|OFF|1|0`

`:DISPlay:FSCREEN|FULLSCREEN[:STATe]?`

When the full screen function is activated, the measurement window expands horizontally over the entire instrument display. That is, it turns off the display of the softkey labels. Pressing any other key that results in a new menu cancels the full screen function.

State Saved: Not saved in state.

Factory Preset: Off

Factory
Preset: Off

Front Panel
Access: **Display**

Example: DISP:FSCR ON

History: PSA: Added with firmware revision A.02.00

PVT - Limit Mask Display

`:DISPlay:PVTime:LIMit:MASK OFF|ON|0|1`

`:DISPlay:PVTime:LIMit:MASK?`

Turns on/off the display function of the limit mask lines. It also controls the limit checking function.

See also [:SENS]:PVT:LIM:MASK.

Factory Preset: ON

Remarks: You must be in GSM, EDGE, 1xEV-DO or W-CDMA mode to use this command. Use INSTRument:SElect to set the mode.

Front Panel
Access: **Power vs Time, Display**

Spectrum - Y-Axis Scale/Div

`:DISPlay:SPECTrum[n]:WINDow[m]:TRACe:Y[:SCALe]:PDIVision`

<power>

:DISPlay:SPECTrum[n]:WINDow[m]:TRACe:Y[:SCALE]:PDIVision?

Sets the scale per division for the y-axis.

n – selects the view, the default is Spectrum.

m – selects the window within the view. The default is 1.

n=1, m=1 Spectrum

n=1, m=2 I/Q Waveform

n=1, m=2 I and Q Waveform (Basic, W-CDMA, cdma2000)

n=1, m=3 numeric data (Service mode, E4406A only)

n=1, m=4 RF envelope (Service mode, E4406A only)

n=2, m=1 I Waveform (Option B7C, E4406A only)

n=2, m=2 Q Waveform (Option B7C, E4406A only)

n=3, m=1 I/Q Polar (Basic, W-CDMA, cdma2000)

n=4, m=1 Linear Spectrum (Basic, W-CDMA, cdma2000)

Factory Preset: 10 dB per division, for Spectrum

100 mV per division, for I/Q Waveform

Range: 0.1 dB to 20 dB per division, for Spectrum

1 nV to 20 V per division, for I/Q Waveform

Default Unit: 10 dB per division, for Spectrum

Remarks: May affect input attenuator setting.

For E4406A to use this command, the appropriate mode should be selected with INSTRUMENT:SELEct.

For PSA you must be in Basic, cdmaOne, cdma2000, 1xEV-DO, W-CDMA GSM w/EDGE, NADC, or PDC mode. Set the mode with INSTRUMENT:SELEct.

Front Panel

Access: When in Spectrum measurement: **Amplitude Y Scale, Scale/Div.**

History: For PSA:
 Added revision A.02.00

For E4406A:
 Modified revision A.05.00

Spectrum - Y-Axis Reference Level

```
:DISPlay:SPECTrum[n]:WINDow[m]:TRACe:Y[:SCALe]:RLEVel  
<power>
```

```
:DISPlay:SPECTrum[n]:WINDow[m]:TRACe:Y[:SCALe]:RLEVel?
```

Sets the amplitude reference level for the y-axis.

n, selects the view, the default is RF envelope.

n=1, m=1 Spectrum

n=1, m=2 I/Q Waveform

n=1, m=2 I and Q Waveform (Basic, W-CDMA, cdma2000)

n=1, m=3 numeric data (Service mode, E4406A only)

n=1, m=4 RF envelope (Service mode, E4406A only)

n=2, m=1 I Waveform (Option B7C, E4406A only)

n=2, m=2 Q Waveform (Option B7C, E4406A only)

n=3, m=1 I/Q Polar (Basic, W-CDMA, cdma2000)

n=4, m=1 Linear Spectrum (Basic, W-CDMA, cdma2000)

m – selects the window within the view. The default is 1.

Factory Preset: 0 dBm, for Spectrum

Range: -250 to 250 dBm, for Spectrum

Default Unit: dBm, for Spectrum

Remarks: May affect input attenuator setting.

For E4406A to use this command, the appropriate mode should be selected with INSTRUMENT:SElect.

For PSA you must be in Basic, cdmaOne, cdma2000, 1xEV-DO, W-CDMA GSM w/EDGE, NADC, or PDC mode. Set the mode with INSTRUMENT:SElect.

Front Panel

Access: When in Spectrum measurement: **Amplitude Y Scale, Ref Level**

History: For PSA:
Added revision A.02.00

For E4406A:
Modified revision A.05.00

Turn a Trace Display On/Off

:DISPlay:TRACe [n] [:STATe] OFF|ON|0|1

:DISPlay:TRACe [n] [:STATe] ?

Controls whether the specified trace is visible or not.

n is a sub-opcode that is valid for the current measurement. See the “MEASure Group of Commands” on page 347 for more information about sub-opcodes.

Factory Preset: On

Range: The valid traces and their sub-opcodes are dependent upon the selected measurement. See the following table.

The trace name assignment is independent of the window number.

Remarks: For E4406A to use this command, the appropriate mode should be selected with INSTRument:SElect.

Remarks: For PSA you must be in the Basic, cdmaOne, cdma2000, 1xEV-DO, W-CDMA, GSM (w/EDGE), NADC, or PDC mode to use this command. Use INSTRument:SElect to set the mode

Front Panel

Access: Display, Display Traces

| Measurement | Available Traces | Markers Available? |
|--|--|--------------------|
| ACP - adjacent channel power (Basic, cdmaOne, cdma2000, W-CDMA, iDEN (E4406A only), WiDEN (E4406A only), NADC, PDC modes) | no traces $(n=0)^a$ for I/Q points | no markers |
| BER - bit error rate (iDEN, WiDEN mode, E4406A only) | no traces $(n=0)^a$ for I/Q data | no markers |
| CDPower - code domain power (cdmaOne mode) | POWer $(n=2)^a$ TIMing $(n=3)^a$ PHASe $(n=4)^a$ $(n=0)^a$ for I/Q points | yes |

| Measurement | Available Traces | Markers Available? |
|--|--|---|
| CDPower - code domain power (cdma2000, 1xEV-DO, W-CDMA modes) | ($n=0$) ^a for I/Q raw data CDPower ($n=2$) ^a EVM ($n=5$) ^a MERRor ($n=6$) ^a PERRor ($n=7$) ^a SPOWer ($n=9$) ^a CPOWer ($n=10$) ^a | yes |
| CHPower - channel power (Basic, cdmaOne, cdma2000, 1xEV-DO, W-CDMA modes) | SPECtrum ($n=2$) ^a ($n=0$) ^a for I/Q raw data | no markers |
| CSPur - spurs close (cdmaOne mode) | SPECtrum ($n=2$) ^a ULIMit ($n=3$) ^a ($n=0$) ^a for I/Q points | yes |
| EEVM - EDGE error vector magnitude (EDGE mode) | EVMerror ($n=2$) ^a MERRor ($n=3$) ^a PERRor ($n=4$) ^a ($n=0$) ^a for I/Q points | yes |
| EORFspectr - EDGE output RF spectrum (EDGE mode) | RFEMod ($n=2$) ^a RFESwitching ($n=3$) ^a SPEMod ($n=4$) ^a LIMMod ($n=5$) ^a ($n=0$) ^a for I/Q points | yes, only for a single offset yes, only for multiple offsets |
| EPVTime - EDGE power versus time (EDGE mode) | RFENvelope ($n=2$) ^a UMASk ($n=3$) ^a LMASk ($n=4$) ^a ($n=0$) ^a for I/Q points | yes |

| Measurement | Available Traces | Markers Available? |
|--|---|---|
| ETSPur - EDGE transmit band spurs (EDGE mode) | SPECTrum ($n=2$) ^a ULIMit ($n=3$) ^a $(n=0)$ ^a for I/Q points | yes |
| EVM - error vector magnitude (NADC, PDC modes) | EVM ($n=2$) ^a MERRor ($n=3$) ^a PERRor ($n=4$) ^a $(n=0)$ ^a for I/Q points | yes |
| EVMQpsk - QPSK error vector magnitude (cdma2000, 1xEV-DO, W-CDMA modes) | EVM ($n=2$) ^a MERRor ($n=3$) ^a PERRor ($n=4$) ^a $(n=0)$ ^a for I/Q raw data | yes |
| IM - intermodulation (cdma2000, 1xEV-DO, W-CDMA modes) | SPECTrum ($n=2$) ^a $(n=0)$ ^a for I/Q raw data | yes |
| MCPower - multi-carrier power (W-CDMA mode) | no traces $(n=0)$ ^a for I/Q points | no markers |
| OBW - occupied bandwidth (cdmaOne, cdma2000, 1xEV-DO, iDEN (E4406A only), WiDEN (E4406A only), PDC, W-CDMA modes) | no traces $(n=0)$ ^a for I/Q raw data | no markers |
| ORFSpectrum - output RF spectrum (GSM, EDGE mode) | RFEMod ($n=2$) ^a RFESwitching ($n=3$) ^a SPEMod ($n=4$) ^a LIMMod ($n=5$) ^a $(n=0)$ ^a for I/Q points | yes, only for a single offset yes, only for multiple offsets |
| PFERror - phase and frequency error (GSM, EDGE mode) | PERRor ($n=2$) ^a PFERror ($n=3$) ^a RFENvelope ($n=4$) ^a $(n=0)$ ^a for I/Q points | yes |

| Measurement | Available Traces | Markers Available? |
|---|--|--------------------|
| PSTatistic - power statistics CCDF (Basic, cdma2000, 1xEV-DO, W-CDMA modes) | MEASured ($n=2$) ^a GAUSian ($n=3$) ^a REFerence ($n=4$) ^a ($n=0$) ^a for I/Q points | yes |
| PVTime - power versus time (GSM, EDGE, 1xEV-DO, Service (E4406A only) modes) | ($n=0$) ^a for I/Q raw data RFENvelope ($n=2$) ^a UMASk ($n=3$) ^a LMASk ($n=4$) ^a | yes |
| RHO - modulation quality (cdmaOne, cdma2000, W-CDMA mode) | ($n=0$) ^a for I/Q raw data EVM ($n=2$) ^a MERRor ($n=3$) ^a PERRor ($n=4$) ^a ($n=5$) ^a for I/Q corrected trace data | yes |
| RHO - modulation quality (1xEV-DO mode) | ($n=0$) ^a for I/Q raw data ($n=1$) ^a for various summary results EVM ($n=2$) ^a MERRor ($n=3$) ^a PERRor ($n=4$) ^a ($n=5$) ^a for I/Q corrected trace data | yes |
| SEMask - spectrum emissions mask (cdma2000, 1xEV-DO, W-CDMA mode) | SPECtrum ($n=2$) ^a ($n=0$) ^a for I/Q raw data | yes |
| TSPur - transmit band spurs (GSM, EDGE mode) | SPECtrum ($n=2$) ^a ULIMit ($n=3$) ^a ($n=0$) ^a for I/Q points | yes |

| Measurement | Available Traces | Markers Available? |
|--|--|--------------------|
| TXPower - transmit power (GSM, EDGE mode) | RFENvelope ($n=2$) ^a IQ ($n=8$) ^a ($n=0$) ^a for I/Q points | yes |
| SPECTrum - (frequency domain) (all modes) | RFENvelope ($n=2$) ^a for Service mode (E4406A only) IQ ($n=3$) ^a SPECTrum ($n=4$) ^a ASPectrum ($n=7$) ^a ($n=0$) ^a for I/Q raw data | yes |
| WAVEform - (time domain) (all modes) | RFENvelope ($n=2$) ^a (also for Signal Envelope trace) IQ ($n=5$) ^a ($n=0$) ^a for I/Q raw data | yes |

a. The n number indicates the sub-opcode that corresponds to this trace. Detailed descriptions of the trace data can be found in the MEASure subsystem documentation by looking up the sub-opcode for the appropriate measurement.

Waveform - Y-Axis Scale/Div

```
:DISPlay:WAVEform [n] :WINDow [m] :TRACe:Y[:SCALE] :PDIVision  
<power>
```

```
:DISPlay:WAVEform [n] :WINDow [m] :TRACe:Y[:SCALE] :PDIVision?
```

Sets the scale per division for the y-axis.

n , selects the view, the default is RF envelope.

$n=1$, $m=1$ RF envelope

$n=2$, $m=1$ I/Q Waveform

$n=2$, $m=1$ I and Q Waveform (Option B7C, E4406A only)

$n=4$, $m=1$ I/Q Polar (Basic, W-CDMA, cdma2000)

n=5, m=1 Linear Envelope (Option B7C, E4406A only)

m, selects the window within the view. The default is 1.

Factory Preset: 10 dBm, for RF envelope

Range: .1 dB to 20 dB, for RF envelope

Default Unit: dBm, for RF envelope

Remarks: May affect input attenuator setting.

For E4406A to use this command, the appropriate mode should be selected with INSTRUMENT:SElect.

For PSA you must be in Basic, cdmaOne, cdma2000, 1xEV-DO, W-CDMA GSM w/EDGE, NADC, or PDC mode. Set the mode with INSTRUMENT:SElect.

Front Panel

Access: When in Waveform measurement: **Amplitude Y Scale, Scale/Div.**

History: For PSA:
Added revision A.02.00

For E4406A:
Modified revision A.05.00

Waveform - Y-Axis Reference Level

```
:DISPlay:WAVeform[n] :WINDow[m] :TRACe:Y[:SCALe] :RLEVel  
<power>
```

```
:DISPlay:WAVeform[n] :WINDow[m] :TRACe:Y[:SCALe] :RLEVel?
```

Sets the amplitude reference level for the y-axis.

n, selects the view, the default is RF envelope.

n=1, m=1 RF envelope

n=2, m=1 I/Q Waveform

n=2, m=1 I and Q Waveform (Option B7C, E4406A only)

n=4, m=1 I/Q Polar (Basic, W-CDMA, cdma2000)

n=5, m=1 Linear Envelope (Option B7C, E4406A only)

m, selects the window within the view. The default is 1.

Factory Preset: 0 dBm, for RF envelope

Range: -250 to 250 dBm, for RF envelope

Default Unit: dBm, for RF envelope

Remarks: May affect input attenuator setting.
For E4406A to use this command, the appropriate mode should be selected with INSTRument:SElect.
For PSA you must be in Basic, cdmaOne, cdma2000, 1xEV-DO, W-CDMA GSM w/EDGE, NADC, or PDC mode. Set the mode with INSTRument:SElect.

Front Panel Access: When in Waveform measurement: **Amplitude Y Scale, Ref Level**

History: For PSA:
Added revision A.02.00
For E4406A:
Modified revision A.05.00

FETCh Subsystem

The FETCh? queries are used with several other commands to control the measurement process. These commands are described in the section on the “[MEASure Group of Commands](#)” on [page 347](#). These commands apply only to measurements found in the MEASURE menu.

This command puts selected data from the most recent measurement into the output buffer (new data is initiated/measured). Use FETCh if you have already made a good measurement and you want to look at several types of data (different [n] values) from the single measurement. FETCh saves you the time of re-making the measurement. You can only fetch results from the measurement that is currently active.

If you need to make a new measurement, use the READ command, which is equivalent to an INITiate[:IMMEDIATE] followed by a FETCh.

:FETCh <meas>? returns valid data only when the measurement is in one of the following states:

- idle
- initiated
- paused

Fetch the Current Measurement Results

:FETCh: <measurement> [n] ?

A FETCh? command must specify the desired measurement. It returns the valid results that are currently available, but does not initiate the taking of any new data. You can only fetch results from the measurement that is currently selected. The code number n selects the kind of results that are returned. The available measurements and data results are described in the “[MEASure Group of Commands](#)” on [page 347](#).

FORMat Subsystem

The FORMat subsystem sets a data format for transferring numeric and array information. For PSA the TRACe[:DATA] command is affected by FORMat subsystem commands.

Byte Order

:FORMat:BORDER NORMAl|SWAPped

:FORMat:BORDER?

Selects the binary data byte order for numeric data transfer. In normal mode the most significant byte is sent first. In swapped mode the least significant byte is first. (PCs use the swapped order.) Binary data byte order functionality does not apply to ASCII.

Factory Preset: Normal

Remarks: You must be in the Basic, cdma2000, 1xEV-DO, W-CDMA, GSM (w/EDGE), NADC, or PDC mode to use this command. Use INSTRument:SElect to set the mode.

Numeric Data Format

PSA/VSA Basic, cdmaOne, cdma2000, 1xEV-DO, W-CDMA, GSM, EDGE, NADC, PDC modes:

:FORMat[:DATA] ASCii|REAL,32|REAL,64

:FORMat[:DATA]?

PSA Spectrum Analysis mode only:

:FORMat[:TRACe][:DATA]

ASCii|INTeger,16|INTeger,32|REAL,32|REAL,64|UINTeger,16

:FORMat[:TRACe][:DATA]?

PSA Noise Figure mode only:

:FORMat[:TRACe][:DATA] ASCii|REAL[,32]

:FORMat[:TRACe][:DATA]?

VSA/PSA application modes: This command controls the format of data input/output, that is any data transfer across any remote port. The REAL and ASCII formats format data in the current display units. The format of state data cannot be changed. It is always in a machine

readable format only.

ASCII - Amplitude values are in ASCII, in amplitude units, separated by commas. ASCII format requires more memory than the binary formats. Therefore, handling large amounts of this type of data takes more time and storage space.

Integer,16 - Binary 16-bit integer values in internal units (dBm), in a definite length block. **PSA, SA mode only.

Integer,32 - Binary 32-bit integer values in internal units (dBm), in a definite length block.

Real,32 or Real,64 - Binary 32-bit (or 64-bit) real values in amplitude unit, in a definite length block. Transfers of real data are done in a binary block format.

UINTeger,16 - Binary 16-bit unsigned integer that is uncorrected ADC values, in a definite length block. This format is almost never applicable with current measurement data.

A definite length block of data starts with an ASCII header that begins with # and indicates how many additional data points are following in the block. Suppose the header is #512320.

- The first digit in the header (5) tells you how many additional digits/bytes there are in the header.
- The 12320 means 12 thousand, 3 hundred, 20 data bytes follow the header.
- Divide this number of bytes by your selected data format bytes/point, either 8 (for real 64), or 4 (for real 32). In this example, if you are using real 64 then there are 1540 points in the block.

Example: FORM REAL,64

Factory Preset: ASCII

Real,32 for Spectrum Analysis mode

ASCII for Basic, cdmaOne, cdma2000, 1xEV-DO,
W-CDMA, GSM with EDGE, NADC, PDC modes

Remarks: The acceptable settings for this command change for the different modes as described above.

INITiate Subsystem

The INITiate subsystem is used to initiate a trigger for a measurement. These commands only initiate measurements from the MEASURE front panel key or the “MEASure Group of Commands” on page 347. Refer also to the TRIGger and ABORt subsystems for related commands.

Take New Data Acquisition for Selected Measurement

:INITiate:<measurement>

This command initiates a trigger cycle for the measurement specified, but does not return data. The available measurement names are described in the MEASure subsystem.

If your selected measurement is not currently active, it changes to the measurement in your INIT:<meas> command, and initiates a trigger cycle.

For PSA this command is not available for one-button measurements in the Spectrum Analysis mode.

Example: INIT:ACP

Continuous or Single Measurements

:INITiate:CONTinuous OFF|ON|0|1

:INITiate:CONTinuous?

Selects whether a trigger is continuously initiated or not. Each trigger initiates a single, complete, measurement operation.

When set to ON another trigger cycle is initiated at the completion of each measurement.

When set to OFF, the trigger system remains in the “idle” state until an INITiate[:IMMediate] command is received. On receiving the INITiate[:IMMediate] command, it goes through a single trigger/measurement cycle, and then returns to the “idle” state.

Example: INIT:CONT ON

Factory Preset: On

*RST: Off (recommended for remote operation)

Front Panel

Access: **Meas Control, Measure Cont Single**

Take New Data Acquisitions

:INITiate[:IMMEDIATE]

The instrument must be in the single measurement mode. If INIT:CONT is ON, then the command is ignored. The desired measurement must be selected and waiting. The command causes the system to exit the “waiting” state and go to the “initiated” state.

The trigger system is initiated and completes one full trigger cycle. It returns to the “waiting” state on completion of the trigger cycle. Depending upon the measurement and the number of averages, there may be multiple data acquisitions, with multiple trigger events, for one full trigger cycle.

This command triggers the instrument, if external triggering is the type of trigger event selected. Otherwise, the command is ignored. Use the TRIGGER[:SEQUENCE]:SOURCE EXT command to select the external trigger.

Example: INIT:IMM

Remarks: See also the *TRG command and the TRIGGER subsystem.

Front Panel

Access: **Meas Control, Measure Cont Single**

Restart the Measurement

:INITiate:REStart

This command applies to measurements found in the MEASURE menu. It restarts the current measurement from the “idle” state regardless of its current operating state. It is equivalent to:

INITiate[:IMMEDIATE]

ABORT (for continuous measurement mode)

Example: INIT:REST

Front Panel

Access: **Restart**

or

Meas Control, Restart

INSTRUMENT Subsystem

This subsystem includes commands for querying and selecting instrument measurement (personality option) modes.

Catalog Query

For E4406A, `:INSTRUMENT:CATALOG[:FULL]?`

For PSA, `:INSTRUMENT:CATALOG?`

Returns a comma separated list of strings which contains the names of all the installed applications. These names can only be used with the `INST:SELECT` command.

For E4406A if the optional keyword `FULL` is specified, each name is immediately followed by its associated instrument number. These instrument numbers can only be used with the `INST:NSELECT` command.

Example:

(PSA) `INST:CAT?`

Query response: "CDMA"4,"PNOISE"14

Example:

(E4406A) `INST:CAT:FULL?`

Query response:
 "BASIC"8,"GSM"3,"CDMA"4,"SERVICE"1

Select Application by Number

`:INSTRUMENT:NSELECT <integer>`

`:INSTRUMENT:NSELECT?`

Select the measurement mode by its instrument number. The actual available choices depends upon which applications are installed in the instrument. For E4406A these instrument numbers can be obtained with `INST:CATALOG:FULL?`

- 1 = SA (PSA)
- 1 = SERVICE (E4406A)
- 3 = GSM (GSM on E4406A)
- 4 = CDMA (cdmaOne) (E4406/PSA)
- 5 = NADC (E4406/PSA)
- 6 = PDC (E4406/PSA)
- 8 = BASIC (E4406/PSA)
- 9 = WCDMA (3GPP W-CDMA with HSDPA/HSUPA) (E4406/PSA)

10 = CDMA2K (cdma2000 with 1xEV-DV) (E4406/PSA)
11 = IDEN (E4406A)
13 = EDGE GSM (E4406/PSA)
14 = PNOISE (phase noise) (PSA)
15 = CMDA1XEV (1xEV-D0) (E4406/PSA)
18 = WLAN (PSA)
211 = TDSCDMA (PSA)
219 = NOISE FIGURE (PSA)
233 = MRECEIVE (PSA)
241 = DMODULATION (PSA)

NOTE

If you are using the SCPI status registers and the analyzer mode is changed, the status bits should be read, and any errors resolved, prior to switching modes. Error conditions that exist prior to switching modes cannot be detected using the condition registers after the mode change. This is true unless they recur after the mode change, although transitions of these conditions can be detected using the event registers.

Changing modes resets all SCPI status registers and mask registers to their power-on defaults. Hence, any event or condition register masks must be re-established after a mode change. Also note that the power up status bit is set by any mode change, since that is the default state after power up.

Example: INST:NSEL 4

Factory Preset: Persistent state with factory default of 1 (PSA)

Persistent state with factory default of 8
(E4406A, BASIC)

Range: 1 to x, where x depends upon which applications are installed.

Front Panel

Access: **MODE**

Select Application

VSA E4406A:

```
:INSTrument [:SElect]
BASIC | SERVICE | CDMA | CDMA2K | GSM | EDGE GSM | IDEN | NADC
| PDC | WCDMA | CDMA1XEV
```

PSA Series:

```
:INSTrument [:SElect]
SA | PNOISE | BASIC | CDMA | CDMA2K | EDGE GSM | NADC | PDC
| WCDMA | CDMA1XEV | NFIGURE | WLAN | MRECEIVE
```

:INSTrument [:SElect] ?

Select the measurement mode. The actual available choices depend upon which modes (measurement applications) are installed in the instrument. A list of the valid choices is returned with the INST:CAT? query.

Once an instrument mode is selected, only the commands that are valid for that mode can be executed.

- 1 = SA (PSA)
- 1 = SERVICE (E4406A)
- 3 = GSM (GSM on E4406A)
- 4 = CDMA (cdmaOne) (E4406/PSA)
- 5 = NADC (E4406/PSA)
- 6 = PDC (E4406/PSA)
- 8 = BASIC (E4406/PSA)
- 9 = WCDMA (3GPP W-CDMA with HSDPA/HSUPA) (E4406/PSA)
- 10 = CDMA2K (cdma2000 with 1xEV-DV) (E4406/PSA)
- 11 = IDEN (E4406A)
- 13 = EDGE GSM (E4406/PSA)
- 14 = PNOISE (phase noise) (PSA)
- 15 = CMDA1XEV (1xEV-D0) (E4406/PSA)
- 18 = WLAN (PSA)
- 211 = TDSCDMA (PSA)
- 219 = NOISE FIGURE (PSA)
- 233 = MRECEIVE (PSA)
- 241 = DMODULATION (PSA)

NOTE

If you are using the status bits and the analyzer mode is changed, the status bits should be read, and any errors resolved, prior to switching modes. Error conditions that exist prior to switching modes cannot be detected using the condition registers after the mode change. This is true unless they recur after the mode change, although transitions of these conditions can be detected using the event registers.

Changing modes resets all SCPI status registers and mask registers to their power-on defaults. Hence, any event or condition register masks must be re-established after a mode change. Also note that the power up status bit is set by any mode change, since that is the default state after power up.

Example: INST:SEL CDMA

Factory Preset:
 (PSA) Persistent state with factory default of Spectrum Analyzer mode

Factory Preset:
 (E4406A) Persistent state with factory default of Basic mode.

Front Panel

Programming Commands
INSTRument Subsystem

Access: **MODE**

MEASure Group of Commands

This group includes the CONFigure, FETCh, MEASure, and READ commands that are used to make measurements and return results. The different commands can be used to provide fine control of the overall measurement process, like changing measurement parameters from their default settings. Most measurements should be done in single measurement mode, rather than measuring continuously.

The SCPI default for the format of any data output is ASCII. The format can be changed to binary with FORMat:DATA which transports faster over the bus.

Command Interactions: MEASure, CONFigure, FETCh, INITiate and READ

Figure 4-3 Measurement Group of Commands

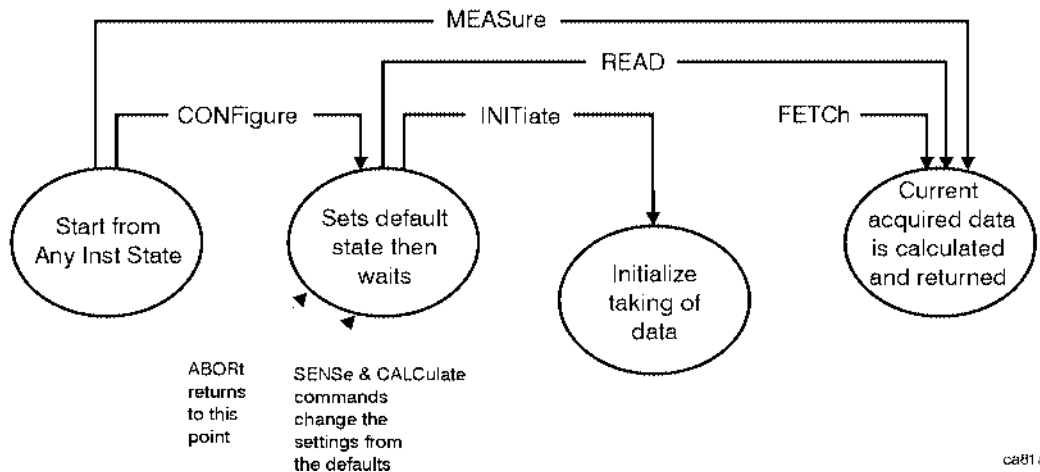

Measure Commands:

:MEASure:<measurement> [n] ?

This is a fast single-command way to make a measurement using the factory default instrument settings. These are the settings and units that conform to the Mode Setup settings (e.g. radio standard) that you have currently selected.

- Stops the current measurement (if any) and sets up the instrument for the specified measurement using the factory defaults
- Initiates the data acquisition for the measurement
- Blocks other SCPI communication, waiting until the measurement is complete before returning results.
- After the data is valid it returns the scalar results, or the trace data, for the specified measurement. The type of data returned may be defined by an [n] value that is sent with the command.

The scalar measurement results are returned if the optional [n] value is not included, or is set to 1. If the [n] value is set to a value other than 1, the selected trace data results are returned. See each command for details of what types of scalar results or trace data results are available.

ASCII is the default format for the data output. (Older versions of Spectrum Analysis and Phase Noise mode measurements only use ASCII.) The binary data formats should be used for handling large blocks of data since they are smaller and faster than the ASCII format. Refer to the FORMat:DATA command for more information.

If you need to change some of the measurement parameters from the factory default settings you can set up the measurement with the CONFigure command. Use the commands in the SENSE:<measurement> and CALCulate:<measurement> subsystems to change the settings. Then you can use the READ? command to initiate the measurement and query the results. See [Figure 4-3](#).

If you need to repeatedly make a given measurement with settings other than the factory defaults, you can use the commands in the SENSE:<measurement> and CALCulate:<measurement> subsystems to set up the measurement. Then use the READ? command to initiate the measurement and query results.

Measurement settings persist if you initiate a different measurement and then return to a previous one. Use READ:<measurement>? if you want to use those persistent settings. If you want to go back to the default settings, use MEASure:<measurement>?.

Configure Commands:

:CONFigure:<measurement>

This command stops the current measurement (if any) and sets up the instrument for the specified measurement using the factory default instrument settings. It sets the instrument to single measurement mode but should not initiate the taking of measurement data unless INIT:CONTinuous is ON. After you change any measurement settings, the READ command can be used to initiate a measurement without changing the settings back to their defaults.

NOTE In instruments with firmware older than A.05.00 CONFigure initiates the taking of data. The data should be ignored. Other SCPI commands can be processed immediately after sending CONFigure. You do not need to wait for the CONF command to complete this 'false' data acquisition.

The CONFigure? query returns the current measurement name.

Fetch Commands:

:FETCh:<measurement> [n] ?

This command puts selected data from the most recent measurement into the output buffer. Use FETCh if you have already made a good measurement and you want to return several types of data (different [n] values, e.g. both scalars and trace data) from a single measurement. FETCh saves you the time of re-making the measurement. You can only FETCh results from the measurement that is currently active. The FETCh command does not cause a change to a different measurement.

If you need to get new measurement data, use the READ command, which is equivalent to an INITiate followed by a FETCh.

The scalar measurement results are returned if the optional [n] value is not included, or is set to 1. If the [n] value is set to a value other than 1, the selected trace data results are returned. See each command for details of what types of scalar results or trace data results are available. The binary data formats should be used for handling large blocks of data since they are smaller and transfer faster than the ASCII format. (FORMat:DATA)

FETCh may be used to return results other than those specified with the original READ or MEASure command that you sent.

INITiate Commands:

:INITiate:<measurement>

This command is not available for measurements in all the instrument modes:

- Initiates a trigger cycle for the specified measurement, but does not output any data. You must then use the FETCh<meas> command to return data. If a measurement other than the current one is specified, the instrument switches to that measurement and then initiates it.

For example, suppose you have previously initiated the ACP measurement, but now you are running the Channel Power measurement. If you send INIT:ACP?, it changes from Channel Power to ACP and initiates an ACP measurement.
- Does not change any of the measurement settings. For example, if you have previously started the ACP measurement, and you send INIT:ACP?, it initiates a new ACP measurement using the same instrument settings as the last time ACP was run.
- If your selected measurement is currently active (in the idle state) it triggers the measurement, assuming the trigger conditions are met. Then it completes one trigger cycle. Depending upon the measurement and the number of averages, there may be multiple data acquisitions, with multiple trigger events, for one full trigger cycle. It also holds off additional commands on GPIB until the acquisition is complete.

READ Commands:

:READ:<measurement> [n] ?

- Does not preset the measurement to the factory default settings. For example, if you have previously initiated the ACP measurement, and you send READ:ACP?, it initiates a new measurement using the same instrument settings.
- Initiates the measurement and puts valid data into the output buffer. If a measurement other than the current one is specified, the instrument switches to that measurement before it initiates the measurement and returns results.

For example, suppose you have previously initiated the ACP measurement, but now you are running the Channel Power measurement. Then you send READ:ACP? It changes from Channel Power back to ACP and, using the previous ACP settings, initiates the measurement and returns results.

- Blocks other SCPI communication, waiting until the measurement is complete before returning the results

If the optional [n] value is not included, or is set to 1, the scalar measurement results are returned. If the [n] value is set to a value other than 1, the selected trace data results are returned. See each command for details of what types of scalar results or trace data results are available. The binary data formats should be used when handling large blocks of data since they are smaller and faster than the ASCII format. (FORMat:DATA)

50 MHz Amplitude Reference Measurement

This aligns the internal 50 MHz reference signal to an external reference signal that you supply. You must be in the Service mode to use these commands. Use INSTRument:SElect to set the mode.

The general functionality of CONFigure, FETCh, MEASure, and READ are described at the beginning of this section. See the SENSE:AREference commands for more measurement related commands.

```
:CONFigure:AREference
:INITiate:AREference
:FETCh:AREference [n] ?
:READ:AREference [n] ?
:MEASure:AREference [n] ?
```

Remarks: For auto adjustment of the internal 50 MHz amplitude reference, use CALibration:AMPLitude:REference:AADJust command after this measurement has been selected.

Front Panel

Access: **Measure, 50 MHz Amptd**

After the measurement is selected, press **Restore Meas Defaults** to restore factory defaults.

Measurement Results Available

| n | Results Returned |
|------------------------|--|
| n=1 (or not specified) | Returns scalar results: <ol style="list-style-type: none"> 1. RF input average amplitude 2. 50 MHz reference oscillator average amplitude 3. Average amplitude error 4. State (for factory use only) 5. Level (for factory use only) 6. Monitored level (for factory use only) 7. Connector status (for factory use only) |
| 2 | RF input amplitude trace data. |
| 3 | 50 MHz oscillator amplitude trace data |
| 4 | Amplitude error strip chart trace data |

EDGE Error Vector Magnitude Measurement

This measures the vector error of the magnitude of each symbol. You must be in the EDGE(w/GSM) mode to use these commands. Use INSTRument:SElect to set the mode.

The general functionality of CONFigure, FETCh, MEASure, and READ are described at the beginning of this section. See the SENSE:EEVM commands for more measurement related commands.

:CONFigure:EEVM

:INITiate:EEVM

:FETCh:EEVM [n] ?

:READ:EEVM [n] ?

:MEASure:EEVM [n] ?

History: Version A.04.00 or later

Front Panel

Access: **Measure, EDGE EVM**

After the measurement is selected, press **Restore Meas Defaults** to restore factory defaults.

Measurement Results Available

| n | Results Returned |
|----------|--|
| 0 | Returns unprocessed I/Q trace data, as a data array of trace point values, in volts. |

| n | Results Returned |
|-------------|--|
| 1 (default) | <p>Returns the following 15 scalar results, in order.</p> <ol style="list-style-type: none"> 1. RMS 95th %tile EVM – a floating point number (in percent) of EVM over 95% of the entire measurement area. 2. RMS EVM – a floating point number (in percent) of EVM over the entire measurement area. 3. Maximum RMS EVM – a floating point number (in percent) of highest EVM over the entire measurement area. 4. Peak EVM – a floating point number (in percent) of the average of the peak EVMs. Take the peak EVMs from each burst and average them together. 5. Maximum peak EVM – a floating point number (in percent) of the maximum peak EVM. Take the peak EVMs from each burst and identify the highest peak. 6. Symbol position of the peak EVM error – an integer number of the symbol position where the peak EVM error is detected. 7. Magnitude error – a floating point number (in percent) of average magnitude error over the entire measurement area. 8. Maximum magnitude error – a floating point number (in percent) of maximum magnitude error over the entire measurement area. 9. Phase error – a floating point number (in degree) of average phase error over the entire measurement area. 10. Maximum Phase error – a floating point number (in degree) of maximum phase error over the entire measurement area. 11. Frequency error – a floating point number (in Hz) of the frequency error in the measured signal. 12. Maximum frequency error – a floating point number (in Hz) of the highest frequency error in the measured signal. 13. I/Q origin offset – a floating point number (in dB) of the I and Q error (magnitude squared) offset from the origin. 14. Droop Error – a floating point number (in dB) of the amplitude droop measured across the 142 symbol burst. 15. Trigger to T0 - a floating-point number of the time interval between the trigger point to T0. T0 means the transition time from symbol 13 to symbol 14 of the midamble training sequence for each time slot. Unit is sec |
| 2 | <p>Returns series of floating point numbers (in percent) that represent each sample in the EVM vector trace for the last slot. The first number is the symbol 0 decision point and there is 1 point per symbol.</p> |
| 3 | <p>Returns series of floating point numbers (in percent) that represent each sample in the magnitude error vector trace for the last slot. The first number is the symbol 0 decision point and there is 1 point per symbol.</p> |

| n | Results Returned |
|----------|--|
| 4 | Returns series of floating point numbers (in degree) that represent each sample in the phase error vector trace for the last slot. The first number is the symbol 0 decision point and there is 1 point per symbol. |
| 5 | <p>Returns series of floating point numbers that alternately represent I and Q pairs of the final corrected measured data for the last slot. The magnitude of each I and Q pair are normalized to 1.0. The first number is the in-phase (I) sample of symbol 0 decision point and the second is the quadrature-phase (Q) sample of symbol 0 decision point. As in the EVM, there is 1 point per symbol, so the series of numbers is:</p> <p style="padding-left: 40px;">1st number = I of the symbol 0 decision point 2nd number = Q of the symbol 0 decision point . . . (2) + 1 (or 3rd) number = I of the symbol 1 decision point (2) + 2 (or 4th) number = Q of the symbol 1 decision point . . . (2) × N + 1 number = I of the symbol N decision point (2) × N + 2 number = Q of the symbol N decision point</p> |
| 6 | <p>Returns comma-separated scalar values of pass/fail (0.0= passed, 1.0= failed) results determined by testing EVM:</p> <ol style="list-style-type: none"> 1. Test results of RMS EVM 2. Test results of Peak EVM 3. Test results of 95% tile EVM 4. Test results of I/Q Origin Offset 5. Test results of Frequency Error |
| 7 | Returns series of integer values that represent the demodulated symbols (octal bits) of the final corrected measured data for the last slot. Each bit/symbol is represented as a value between 0 - 7. All 142 symbols in slot are returned. |

| n | Results Returned |
|----|---|
| 10 | <p>The following results are returned when Burst Sync is set to Training Sequence. All results are calculated after the compensation, with timing offset between amplitude path and phase path. If Burst Sync is set to any other selection, no results are returned.</p> <p>Returns the following 15 scalar results, in order.</p> <ol style="list-style-type: none"> 1. RMS 95th %tile EVM – a floating point number (in percent) of EVM over 95% of the entire measurement area. 2. RMS EVM – a floating point number (in percent) of EVM over the entire measurement area. 3. Maximum RMS EVM – a floating point number (in percent) of highest EVM over the entire measurement area. 4. Peak EVM – a floating point number (in percent) of the average of the peak EVMs. Take the peak EVMs from each burst and average them together. 5. Maximum peak EVM – a floating point number (in percent) of the maximum peak EVM. Take the peak EVMs from each burst and identify the highest peak. 6. Symbol position of the peak EVM error – an integer number of the symbol position where the peak EVM error is detected. 7. Magnitude error – a floating point number (in percent) of average magnitude error over the entire measurement area. 8. Maximum magnitude error – a floating point number (in percent) of maximum magnitude error over the entire measurement area. 9. Phase error – a floating point number (in degree) of average phase error over the entire measurement area. 10. Maximum Phase error – a floating point number (in degree) of maximum phase error over the entire measurement area. 11. Frequency error – a floating point number (in Hz) of the frequency error in the measured signal. 12. Maximum frequency error – a floating point number (in Hz) of the highest frequency error in the measured signal. 13. I/Q origin offset – a floating point number (in dB) of the I and Q error (magnitude squared) offset from the origin. 14. Droop Error – a floating point number (in dB) of the amplitude droop measured across the 142 symbol burst. 15. Trigger to T0 – a floating-point number (in sec) of the time interval between the trigger point and T0. T0 is the transition time from symbol 13 to symbol 14 of the midamble training sequence for each time slot. 16. Timing Offset of amplitude path to phase path – a floating number (in sec) of the time interval of amplitude path to phase path. |

EDGE Output RF Spectrum Measurement

This measures adjacent channel power. From 1 to 15 offsets can be measured at one time. You must be in the EDGE(w/GSM) mode to use these commands. Use INSTRument:SElect to set the mode.

The general functionality of CONFigure, FETCh, MEASure, and READ are described at the beginning of this section. See the SENSE:EORFspectr commands for more measurement related commands.

```
:CONFigure:EORFspectr
:INITiate:EORFspectr
:FETCh:EORFspectr [n] ?
:READ:EORFspectr [n] ?
:MEASure:EORFspectr [n] ?
```

History: Version A.04.00 or later. Modified in version A.05.00.

Front Panel

Access: **Measure, EDGE Output RF Spectrum**

After the measurement is selected, press **Restore Meas Defaults** to restore factory defaults.

Measurement Results Available

The default settings for the MEASure command only measure the carrier and 5 standard offsets. The default does not measure the switching transients. If you use the CONFigure, INITiate, and FETCh commands in place of the MEASure command, you can then use the SENSE commands to change the settings from these defaults. Use [:SENSE]:EORFspectr:LIST:SWITCh CUSTom to select a customized set of offsets. Use [:SENSE]:EORFspectr:TYPE MSWitching to measure switching in addition to measuring modulation. (The measurement takes longer when measuring switching transients.)

| Measurement Method | n | Results Returned |
|--------------------|---|--|
| | 0 | Returns unprocessed I/Q trace data, as a series of trace point values, in volts. The I values are listed first in each pair, using the 0 through even-indexed values. The Q values are the odd-indexed values. |

| Measurement Method | n | Results Returned |
|---|------------------------|---|
| Single Offset | n=1 (or not specified) | Returns measurement results for the specified offset: <ol style="list-style-type: none"> 1. Modulation spectrum power, dB 2. Modulation spectrum power, dBm 3. Switching transient power, dB 4. Switching transient power, dBm |
| Multiple Offsets Switching -or- Multiple Offsets Modulation Discrete Mode | n=1 (or not specified) | Returns a list of values for the modulation spectrum at all the offsets (lower and upper.) This is followed by the switching transients results at all the offsets (lower and upper). Note that the carrier is considered offset zero (0) and is the first set of results sent. Four values are provided for each of the offsets (including the carrier), in this order: <ol style="list-style-type: none"> 1. Negative offset(a) - power relative to carrier (dB) 2. Negative offset(a) - absolute average power (dBm) 3. Positive offset(a) - power relative to carrier (dB) 4. Positive offset(a) - absolute average power (dBm) <p>Values for all possible offsets are sent. Zeros are sent for offsets that have not been defined. The total number of values sent (120) = (4 results/offset) × (15 offsets) × (2 measurement types - modulation & switching)</p> <p>Carrier - modulation measurement values Offset 1 - modulation measurement values ... Offset 14 - modulation measurement values Carrier - switching transients measurement values Offset 1 - switching transients measurement values ... Offset 14- switching transients measurement values</p> <p>This measurement defaults to modulation measurements and not switching measurements. If you want to return the switching measurement values, you must change that default condition and use FETCh or READ to return values, rather than MEASure.</p> <p>NOTE: When using custom modulation and switching offsets the maximum number of measured values returned is: 13 modulation offsets + 0 Hz carrier 4 switching offsets + 0 Hz carrier</p> |
| Multiple Offsets Modulation Sweep Mode | n=1 (or not specified) | Returns measurement results of the closest point to the limit line: <ol style="list-style-type: none"> 1. Frequency 2. Offset frequency from carrier frequency 3. Power in dBm 4. Delta from limit (dB) 5. Delta from reference (dB) |

| Measurement Method | n | Results Returned |
|-----------------------------|----------|---|
| Single Offset | 2 | Returns floating point numbers (in dBm) of the captured trace data. It contains N data points of the “spectrum due to modulation” signal, where N is the specified number of samples. |
| Single Offset | 3 | Returns floating point numbers (in dBm) of the captured trace data. It contains N data points of the “spectrum due to switching transients” signal, where N is the specified number of samples. |
| Multiple Offsets Modulation | 4 | Returns floating point numbers (in dBm) of the sweep spectrum of modulation. |
| Sweep Mode | 5 | Returns floating point numbers (in dBm) of the limit trace. |

| Measurement Method | n | Results Returned |
|--|----------|---|
| <p>Meas Type = Mod & Switch AND Meas Method = Multi-Offset - or - Meas Type = Modulation AND Meas Method = Multi-Offset - or - Meas Type = Switching AND Meas Method = Multi-Offset - or - Meas Type = Full Frame Mod (FAST)</p> | <p>6</p> | <p>Relative level to the test limit, and test limit itself for both modulation and switching transient measurements.</p> <p>Returns a list of relative level to the test limit, the relative test limit and the absolute test limit for all the offset frequencies. The relative level to the test limit is returned for both lower and upper offsets. Four values are returned for each offset in the following order:</p> <ol style="list-style-type: none"> 1. Relative level to the test limit (dB) at the negative offset frequency 2. Relative level to the test limit (dB) at the positive offset frequency 3. Relative test limit used (dB) 4. Absolute test limit used (dBm) <p>Values for all possible offsets are returned.</p> <p>The carrier frequency is considered offset zero (0.0 Hz) and is the first set of values returned.</p> <p>Zeros are returned for offsets that have not been defined.</p> <p>Zeros are returned for the measurement that was not performed. For example, if Meas Type is Modulation, all switching transients measurement results will be 0.0.</p> <p>The total number of values returned is: $120 = (4 \text{ results / offset}) * (15 \text{ offset frequencies}) * (2 \text{ measurement types})$</p> <p>Carrier (Offset A) – modulation measurement results Offset 1 (Offset B) - modulation measurement results Offset 14 (Offset O) - modulation measurement results Carrier (Offset A)– switching transients measurement results Offset 1 (Offset B) – switching transients measurement results Offset 14 (Offset O) – switching transients measurement results</p> |

EDGE Power vs. Time Measurement

This measures the average power during the “useful part” of the burst comparing the power ramp to required timing mask. You must be in EDGE(w/GSM) mode to use these commands. Use INSTRument:SElect to set the mode.

The general functionality of CONFigure, FETCh, MEASure, and READ are described at the beginning of this section. See the SENSE:EPVTime commands for more measurement related commands.

```
:CONFigure:EPVTime
:INITiate:EPVTime
:FETCh:EPVTime [n] ?
:READ:EPVTime [n] ?
:MEASure:EPVTime [n] ?
```

Front Panel

Access: **Measure, EDGE Pwr vs Time**

After the measurement is selected, press **Restore Meas Defaults** to restore factory defaults.

History: Modified in version A.05.00.

Measurement Results Available

| n | Results Returned |
|----------|--|
| 0 | Returns unprocessed I/Q trace data, as a series of trace point values, in volts. The I values are listed first in each pair, using the 0 through even-indexed values. The Q values are the odd-indexed values. |

| n | Results Returned |
|------------------------|---|
| n=1 (or not specified) | <p>Returns the following scalar results:</p> <ol style="list-style-type: none"> 1. Sample time is a floating point number that represents the time between samples when using the trace queries (n=0,2,etc.). 2. Power single burst is the mean power (in dBm) across the useful part of the selected burst in the most recently acquired data, or in the last data acquired at the end of a set of averages. If averaging is on, the power is for the last burst. 3. Power averaged is the power (in dBm) of N averaged bursts, if averaging is on. The power is averaged across the useful part of the burst. Average <i>m</i> is a single burst from the acquired trace. If there are multiple bursts in the acquired trace, only one burst is used for average <i>m</i>. This means that N traces are acquired to make the complete average. If averaging is off, the value of power averaged is the same as the power single burst value. 4. Number of samples is the number of data points in the captured signal. This number is useful when performing a query on the signal (i.e. when n=0,2,etc.). 5. Start is the index of the data point at the start of the useful part of the burst 6. Stop is the index of the data point at the end of the useful part of the burst 7. T_0 is the index of the data point where t_0 occurred 8. Burst width is the width of the burst measured at -3dB below the mean power in the useful part of the burst. 9. Maximum value is the maximum value of the most recently acquired data (in dBm). 10. Minimum value is the minimum value of the most recently acquired data (in dBm). 11. Burst search threshold is the value (in dBm) of the threshold where a valid burst is identified, after the data has been acquired. 12. IQ point delta is the number of data points offset that are internally applied to the useful data in traces $n=2,3,4$. You must apply this correction value to find the actual location of the Start, Stop, or T_0 values. (e.g. for $n=2$, Start (for the IQ trace data) = Start + IQ_point_delta) |
| 2 | Returns trace point values of the entire waveform data. These data points are floating point numbers representing the power of the signal (in dBm). There are N data points, where N is the number of samples . The period between the samples is defined by the sample time . |
| 3 | Returns data points representing the upper mask (in dBm). |
| 4 | Returns data points representing the lower mask (in dBm). |

| n | Results Returned |
|---|--|
| 7 | Returns power level values for the 8 slots in the current frame (in dBm). |
| 8, only available when averaging is set to both maximum and minimum | <p>Returns trace point values of the minimum waveform data. These data points are floating point numbers representing the power of the signal (in dBm). There are N data points, where N is the number of samples. The period between the samples is defined by the sample time.</p> <p>Use SENSE:PVT:AVERAge:TYPE MXMinimum to set averaging to max and min. Use n=2 to return the corresponding maximum trace.</p> |

EDGE Transmit Band Spurs Measure Commands

This measures the spurious emissions in the transmit band relative to the channel power in the selected channel. You must be in the EDGE mode to use these commands. Use INSTRument:SElect to set the mode.

The general functionality of CONFigure, FETCh, MEASure, and READ are described at the beginning of this section. See the SENSE:TSPur commands for more measurement related commands.

:CONFigure:ETSPur

:INITiate:ETSPur

:FETCh:ETSPur [n] ?

:READ:ETSPur [n] ?

:MEASure:ETSPur [n] ?

History: Version A.05.00 or later

Front Panel

Access: **Measure, EDGE Tx Band Spurs**

After the measurement is selected, press **Restore Meas Defaults** to restore factory defaults.

Measurement Results Available

| n | Results Returned |
|------------------------|---|
| 0 | Returns unprocessed I/Q trace data, as a series of trace points, in volts. The I values are listed first in each pair, using the 0 through even-indexed values. The Q values are the odd-indexed values. |
| n=1 (or not specified) | Returns scalar results: <ol style="list-style-type: none"> 1. The worst spur's frequency difference from channel center frequency (in MHz) 2. The worst spur's amplitude difference from the limit (in dB) 3. The worst spur's amplitude difference from the mean transmit power (in dB) |
| 2 | Returns trace of the current segment spectrum. |
| 3 | [Returns trace of the current segment Upper Limit.] |
| 4 | Returns trace of Lower segment Spectrum. |
| 5 | Returns trace of Lower segment Upper Limit. |
| 6 | Returns trace of Lower Adj segment Spectrum. |
| 7 | Returns trace of Lower Adj segment Upper Limit. |

| n | Results Returned |
|----------|---|
| 8 | Returns trace of Upper Adj segment Spectrum. |
| 9 | Returns trace of Upper Adj segment Upper Limit. |
| 10 | Returns trace of Upper segment Spectrum. |
| 11 | Returns trace of Upper segment Upper Limit. |

GMSK Output RF Spectrum Measurement

This measures adjacent channel power. From 1 to 15 offsets can be measured at one time. You must be in the EDGE, GSM mode to use these commands. Use INSTRument:SElect to set the mode.

The general functionality of CONFigure, FETCh, MEASure, and READ are described at the beginning of this section. See the SENSE:ORFSpectrum commands for more measurement related commands.

```
:CONFigure:ORFSpectrum
:INITiate:ORFSpectrum
:FETCh:ORFSpectrum [n] ?
:READ:ORFSpectrum [n] ?
:MEASure:ORFSpectrum [n] ?
```

Front Panel

Access: **Measure, Output RF Spectrum**

After the measurement is selected, press **Restore Meas Defaults** to restore factory defaults.

Measurement Results Available

The default settings for the MEASure command only measure the carrier and 5 standard offsets. The default does not measure the switching transients. If you use the CONFigure, INITiate, and FETCh commands in place of the MEASure command, you can then use the SENSE commands to change the settings from these defaults. Use [:SENSE]:ORFSpectrum:LIST:SWITCh CUSTOM to select a customized set of offsets. Use [:SENSE]:ORFSpectrum:TYPE MSwitching to measure switching in addition to measuring modulation. (The measurement takes longer when measuring switching transients.)

| Measurement Method | n | Results Returned |
|--------------------|------------------------|--|
| | 0 | Returns unprocessed I/Q trace data, as a series of trace point values, in volts. The I values are listed first in each pair, using the 0 through even-indexed values. The Q values are the odd-indexed values. |
| Single Offset | n=1 (or not specified) | Returns measurement results for the specified offset: <ol style="list-style-type: none"> 1. Modulation spectrum power, dB 2. Modulation spectrum power, dBm 3. Switching transient power, dB 4. Switching transient power, dBm |

| Measurement Method | n | Results Returned |
|--|-------------------------------|---|
| <p>Multiple Offsets Switching -or- Multiple Offsets Modulation Discrete Mode</p> | <p>n=1 (or not specified)</p> | <p>Returns a list of values for the modulation spectrum at all the offsets (lower and upper.) This is followed by the switching transients results at all the offsets (lower and upper). Note that the carrier is considered offset zero (0) and is the first set of results sent. Four values are provided for each of the offsets (including the carrier), in this order:</p> <ol style="list-style-type: none"> 1. Negative offset(a) - power relative to carrier (dB) 2. Negative offset(a) - absolute average power (dBm) 3. Positive offset(a) - power relative to carrier (dB) 4. Positive offset(a) - absolute average power (dBm) <p>Values for all possible offsets are sent. Zeros are sent for offsets that have not been defined. The total number of values sent (120) = (4 results/offset) × (15 offsets) × (2 measurement types - modulation & switching)</p> <p>Carrier - modulation measurement values Offset 1 - modulation measurement values ... Offset 14 - modulation measurement values Carrier - switching transients measurement values Offset 1 - switching transients measurement values ... Offset 14- switching transients measurement values</p> <p>This measurement defaults to modulation measurements and not switching measurements. If you want to return the switching measurement values, you must change that default condition and use FETCh or READ to return values, rather than MEASure.</p> <p>NOTE: When using custom modulation and switching offsets the maximum number of measured values returned is:</p> <p>13 modulation offsets + 0 Hz carrier 4 switching offsets + 0 Hz carrier</p> |
| <p>Multiple Offsets Modulation Sweep Mode</p> | <p>n=1 (or not specified)</p> | <p>Returns measurement results of the closest point to the limit line:</p> <ol style="list-style-type: none"> 1. Frequency 2. Offset frequency from carrier frequency 3. Power in dBm 4. delta from limit (dB) 5. delta from reference (dB) |
| <p>Single Offset</p> | <p>2</p> | <p>Returns floating point numbers (in dBm) of the captured trace data. It contains N data points of the “spectrum due to modulation” signal, where N is the specified number of samples.</p> |

| Measurement Method | n | Results Returned |
|---|----------|---|
| Single Offset | 3 | Returns floating point numbers (in dBm) of the captured trace data. It contains N data points of the “spectrum due to switching transients” signal, where N is the specified number of samples. |
| Multiple Offsets Modulation, Sweep Mode | 4 | Returns floating point numbers (in dBm) of the sweep spectrum of modulation. |
| Multiple Offsets Modulation, Sweep Mode | 5 | Returns floating point numbers (in dBm) of the limit trace. |

| Measurement Method | n | Results Returned |
|--|----------|--|
| <p>Meas Type = Mod & Switch AND Meas Method = Multi-Offset - or - Meas Type = Modulation AND Meas Method = Multi-Offset - or - Meas Type = Switching AND Meas Method = Multi-Offset - or - Meas Type = Full Frame Mod (FAST)</p> | <p>6</p> | <p>Relative level to the test limit, and test limit itself for both modulation and switching transient measurements.</p> <p>Returns a list of relative level to the test limit, the relative test limit and the absolute test limit for all the offset frequencies. The relative level to the test limit is returned for both lower and upper offsets. Four values are returned for each offset in the following order:</p> <ol style="list-style-type: none"> 1. Relative level to the test limit (dB) at the negative offset frequency 2. Relative level to the test limit (dB) at the positive offset frequency 3. Relative test limit used (dB) 4. Absolute test limit used (dBm) <p>Values for all possible offsets are returned.</p> <p>The carrier frequency is considered offset zero (0.0 Hz) and is the first set of values returned. Zeros are returned for offsets that have not been defined.</p> <p>Zeros are returned for the measurement that was not performed. For example, if Meas Type is Modulation, all switching transients measurement results will be 0.0.</p> <p>The total number of values returned is: $120 = (4 \text{ results / offset}) * (15 \text{ offset frequencies}) * (2 \text{ measurement types})$</p> <p>Carrier (Offset A) – modulation measurement results Offset 1 (Offset B) - modulation measurement results Offset 14 (Offset O) - modulation measurement results Carrier (Offset A)– switching transients measurement results Offset 1 (Offset B) – switching transients measurement results Offset 14 (Offset O) – switching transients measurement results</p> |

GMSK Phase & Frequency Error Measurement

This measures the modulation quality of the transmitter by checking phase and frequency accuracy. You must be in the EDGE, GSM mode to use these commands. Use INSTRument:SElect to set the mode.

The general functionality of CONFigure, FETCh, MEASure, and READ are described at the beginning of this section. See the SENSE:PFERror commands for more measurement related commands.

```
:CONFigure:PFERror  
:INITiate:PFERror?  
:FETCh:PFERror [n] ?  
:READ:PFERror [n] ?  
:MEASure:PFERror [n] ?
```

Front Panel

Access: **Measure, Phase & Freq**

After the measurement is selected, press **Restore Meas Defaults** to restore factory defaults.

Measurement Results Available

| n | Results Returned |
|---|--|
| 0 | Returns unprocessed I/Q trace data, as a series of trace point values, in volts. The I values are listed first in each pair, using the 0 through even-indexed values. The Q values are the odd-indexed values, |

| n | Results Returned |
|---|--|
| n=1 (or not specified) | <p>Returns the following scalar results:</p> <ol style="list-style-type: none"> 1. RMS phase error is a floating point number (in degrees) of the rms phase error between the measured phase and the ideal phase. The calculation is based on symbol decision points and points halfway between symbol decision points (i.e. 2 points/symbol). If averaging is on, this is the average of the individual rms measurements. 2. Peak phase error is a floating point number (in degrees) of the peak phase error of all the symbol decision points. rms averaging does not affect this calculation. 3. Peak phase symbol is a floating point number (in symbols) representing the symbol number at which the peak phase error occurred. Averaging does not affect this calculation. 4. Frequency error is a floating point number (in Hz) of the frequency error in the measured signal. This is the difference between the measured phase trajectory and the reference phase trajectory. 5. I/Q origin offset is a floating point number (in dB) of the I and Q error (magnitude squared) offset from the origin. 6. Phase sample is a floating point number (in units of bits) representing the time between samples. It is used in querying phase error vector traces. 7. Bit 0 offset is an integer number for the sample point in a phase error vector trace that represents the bit 0 (zero) decision point. The sample points in the trace are numbered 0 to N. 8. Sync start is an integer number for the bit number, within the data bits trace, that represents the start of the sync word. 9. Time sample is a floating point number (in seconds) of the time between samples. It is used in querying time domain traces. For the n=0 trace, of acquired I/Q pairs, this is the time between pairs. 10. Trigger to T₀ is a floating point number (in seconds) of the time interval between the trigger point and T₀. T₀ is the transition time from symbol 13 to symbol 14 of the midamble training sequence for each time slot. |
| 2, and Multi View is the selected view | Returns a series of floating point numbers (in degrees) that represent each sample in the phase error trace. The first number is the symbol 0 decision point and there are 10 points per symbol. Therefore, decision points are at 0, 10, 20, etc. |
| 3, and Multi View is the selected view | Returns a series of floating point numbers (in degrees) that represent each sample in the phase error with frequency trace. Phase error with frequency is the error vector between the measured phase (that has not had frequency compensation) and the ideal reference phase. The calculation is based on symbol decision points and points halfway between symbol decision points (i.e. 2 points/symbol). The first number is the symbol 0 decision point and there are 10 points per symbol. Therefore, decision points are at 0, 10, 20, etc. |

| n | Results Returned |
|---|---|
| 4, and Multi View is the selected view | Returns a series of floating point numbers that represent each sample in the log magnitude trace of the original time record. Each number represents a value (in dBm) of the time record. |
| 5, and IQ Measured Polar Vector is the selected view | <p>Returns a series of floating point numbers that alternately represent I and Q pairs of the corrected measured trace. The magnitude of each I and Q pair are normalized to 1.0. The first number is the in-phase (I) sample of symbol 0 decision point and the second is the quadrature-phase (Q) sample of symbol 0 decision point. As in the rms phase error, there are ten points per symbol, so that:</p> <p>1st number = I of the symbol 0 decision point 2nd number = Q of the symbol 0 decision point .. 10th number = Q of the symbol 0 decision point 11th number = I of the symbol 1 decision point 12th number = Q of the symbol 1 decision point .. 10 × Nth number = Q of the symbol N decision point</p> |
| 6, and Multi View is the selected view | Returns a series of logical values (0 or 1) that represent the demodulated bit value of the measured waveform. The first number is the symbol 0 decision point and there are 10 points per symbol. Therefore, decision points are at 0, 10, 20, etc. |

GMSK Power vs. Time Measurement

For E4406A this measures the average power during the “useful part” of the burst comparing the power ramp to required timing mask. You must be in EDGE, GSM, 1xEV-DO or Service mode to use these commands. Use INSTRument:SElect to set the mode.

For PSA this measures the average power during the “useful part” of the burst comparing the power ramp to required timing mask. You must be in GSM(w/EDGE), or 1xEV-DO mode to use these commands. Use INSTRument:SElect to set the mode.

The general functionality of CONFigure, FETCh, MEASure, and READ are described at the beginning of this section. See the SENSE:PVTime commands for more measurement related commands.

```
:CONFigure:PVTime
:INITiate:PVTime
:FETCh:PVTime [n] ?
:READ:PVTime [n] ?
:MEASure:PVTime [n] ?
```

Front Panel

Access: **Measure, Power vs Time**

After the measurement is selected, press **Restore Meas Defaults** to restore factory defaults.

History: Modified in version A.05.00.

Measurement Results Available

| n | Results Returned |
|---|--|
| 0 | Returns unprocessed I/Q trace data, as a series of trace point values, in volts. The I values are listed first in each pair, using the 0 through even-indexed values. The Q values are the odd-indexed values. |

| n | Results Returned |
|------------------------|---|
| n=1 (or not specified) | <p>Returns the following scalar results:</p> <ol style="list-style-type: none"> 1. Sample time is a floating point number that represents the time between samples when using the trace queries (n=0,2,etc.). 2. Power of single burst is the mean power (in dBm) across the useful part of the selected burst in the most recently acquired data, or in the last data acquired at the end of a set of averages. If averaging is on, the power is for the last burst. 3. Power averaged is the power (in dBm) of N averaged bursts, if averaging is on. The power is averaged across the useful part of the burst. Average <i>m</i> is a single burst from the acquired trace. If there are multiple bursts in the acquired trace, only one burst is used for average <i>m</i>. This means that N traces are acquired to make the complete average. If averaging is off, the value of power averaged is the same as the power single burst value. 4. Number of samples is the number of data points in the captured signal. This number is useful when performing a query on the signal (i.e. when n=0,2,etc.). 5. Start point of the useful part of the burst is the index of the data point at the start of the useful part of the burst 6. Stop point of the useful part of the burst is the index of the data point at the end of the useful part of the burst 7. Index of the data point where T_0 occurred. 8. Burst width of the useful part of the burst is the width of the burst measured at -3dB below the mean power in the useful part of the burst. 9. Maximum value is the maximum value of the most recently acquired data (in dBm). 10. Minimum value is the minimum value of the most recently acquired data (in dBm). 11. Burst search threshold is the value (in dBm) of the threshold where a valid burst is identified, after the data has been acquired. 12. IQ point delta is the number of data points offset that are internally applied to the useful data in traces $n=2,3,4$. You must apply this correction value to find the actual location of the Start, Stop, or T_0 values. |

| n | Results Returned |
|--|--|
| <p>n=1 (or not specified) 1xEV-DO or W-CDMA mode</p> | <p>Returns the following scalar results:</p> <ol style="list-style-type: none"> 1. Sample time is a floating point number that represents the time between samples when using the trace queries (where n = 0, 2, etc.). 2. Power of single burst is the mean power (in dBm) across the useful part of the selected burst in the most recently acquired data, or in the last data acquired at the end of a set of averages. If averaging is on, the power is for the last burst. 3. Power averaged is the power (in dBm) of N averaged bursts, if averaging is on. The power is averaged across the useful part of the burst. Average <i>m</i> is a single burst from the acquired trace. If there are multiple bursts in the acquired trace, only one burst is used for average <i>m</i>. This means that N traces are acquired to make the complete average. If averaging is off, the value of power averaged is the same as the power single burst value. 4. Number of samples (N) is the number of data points in the captured signal. This number is useful when performing a query on the signal (i.e. when n = 0, 2, etc.). 5. Start point of the useful part of the burst is the index of the data point at the start of the useful part of the burst 6. Stop point of the useful part of the burst is the index of the data point at the end of the useful part of the burst 7. Index of the data point where T_0 occurred. 8. Burst width of the useful part of the burst is the width of the burst measured at -3dB below the mean power in the useful part of the burst. 9. Maximum value is the maximum value of the most recently acquired data (in dBm). 10. Minimum value is the minimum value of the most recently acquired data (in dBm). 11. Burst search threshold is the value (in dBm) of the threshold where a valid burst is identified, after the data has been acquired. 12. Averaged number (N) is used to average the measurement results. 13. First position in index to exceed the limit (N) is? 14. Reserved for future use, returns -999.0. 15. Reserved for future use, returns -999.0. 16. Reserved for future use, returns -999.0. 17. Absolute power in the region A (dBm) 18. Absolute power in the region B (dBm) 19. Absolute power in the region C (dBm) 20. Absolute power in the region D (dBm) 21. Absolute power in the region E (dBm) 22. Relative power in the region A (dB) 23. Relative power in the region B (dB) 24. Relative power in the region C (dB) 25. Relative power in the region D (dB) |

| n | Results Returned |
|--|--|
| n=1 (or not specified) (cont.) 1xEV-DO or W-CDMA mode | 26. Relative power in the region E (dB) 27. Maximum absolute power in the region A (dBm) 28. Maximum absolute power in the region B (dBm) 29. Maximum absolute power in the region C (dBm) 30. Maximum absolute power in the region D (dBm) 31. Maximum absolute power in the region E (dBm) 32. Maximum relative power in the region A (dB) 33. Maximum relative power in the region B (dB) 34. Maximum relative power in the region C (dB) 35. Maximum relative power in the region D (dB) 36. Maximum relative power in the region E (dB) 37. Minimum absolute power in the region A (dBm) 38. Minimum absolute power in the region B (dBm) 39. Minimum absolute power in the region C (dBm) 40. Minimum absolute power in the region D (dBm) 41. Minimum absolute power in the region E (dBm) 42. Minimum relative power in the region A (dB) 43. Minimum relative power in the region B (dB) 44. Minimum relative power in the region C (dB) 45. Minimum relative power in the region D (dB) 46. Minimum relative power in the region E (dB) |
| 2 | Returns trace point values of the entire captured I/Q trace data. These data points are floating point numbers representing the power of the signal (in dBm). There are N data points, where N is the number of samples . The period between the samples is defined by the sample time . |
| 3 | Returns data points representing the upper mask (in dBm). |
| 4 | Returns data points representing the lower mask (in dBm). |
| 6 W-CDMA mode | Returns 5 comma-separated scalar values of the pass/fail (0.0=passed, or 1.0=failed) results determined by testing the upper mask. |
| 7 W-CDMA mode | Returns 5 comma-separated scalar values of the pass/fail (0.0=passed, or 1.0=failed) results determined by testing the lower mask: |
| 7 EDGE, GSM, Service mode (E4406A only) GSM (/EDGE) mode (PSA only) | Returns power level values for the 8 slots in the current frame (in dBm). |

Sensor Measurement

This checks the output of three sensors in the RF and IF circuitry. You must be in the Service mode to use these commands. Use `INSTRument:SElect` to set the mode.

The general functionality of `CONFigure`, `FETCh`, `MEASure`, and `READ` are described at the beginning of this section.

```
:CONFigure:SENSors
:INITiate:SENSors
:FETCh:SENSors [n] ?
:READ:SENSors [n] ?
:MEASure:SENSors [n] ?
```

Front Panel

Access: With Service Mode selected, **Measure, Sensors**

Measurement Results Available

| n | Results Returned |
|------------------------|---|
| 0 | Not valid |
| n=1 (or not specified) | Returns the following scalar results: <ol style="list-style-type: none"> 1. IF signal amplitude is the ADC value for the detected 21.4 MHz IF signal at the input to the analog IF. 2. Calibration Oscillator Level is a floating point number (is not implemented, currently returns a zero). 3. RF temperature is a floating point number for the current temperature in the RF section (in degrees Celsius). |

Spectrum (Frequency Domain) Measurement

For E4406A this measures the amplitude of your input signal with respect to the frequency. It provides spectrum analysis capability using FFT (fast Fourier transform) measurement techniques. You must select the appropriate mode using INSTRUMENT:SElect, to use these commands.

For PSA this measures the amplitude of your input signal with respect to the frequency. It provides spectrum analysis capability using FFT (fast Fourier transform) measurement techniques. You must be in the Basic, cdmaOne, cdma2000, 1xEV-DO, W-CDMA, GSM (w/EDGE), NADC, or PDC mode to use these commands. Use INSTRUMENT:SElect, to select the mode.

The general functionality of CONFigure, FETCh, MEASure, and READ are described at the beginning of this section. See the SENSE:SPECTrum commands for more measurement related commands.

```
:CONFigure:SPECTrum
:INITiate:SPECTrum
:FETCh:SPECTrum [n] ?
:READ:SPECTrum [n] ?
:MEASure:SPECTrum [n] ?
```

Front Panel

Access: **Measure, Spectrum (Freq Domain)**

After the measurement is selected, press **Restore Meas Defaults** to restore factory defaults.

Measurement Results Available

| n | Results Returned |
|---|--|
| 0 | Returns unprocessed I/Q trace data, as a series of trace point values, in volts. The I values are listed first in each pair, using the 0 through even-indexed values. The Q values are the odd-indexed values. |

| n | Results Returned |
|-----------------------------|---|
| n=1 (or not specified) | <p>Returns the following scalar results:</p> <ol style="list-style-type: none"> 1. FFT peak is the FFT peak amplitude. 2. FFT frequency is the FFT frequency of the peak amplitude. 3. FFT points is the Number of points in the FFT spectrum. 4. First FFT frequency is the frequency of the first FFT point of the spectrum. 5. FFT spacing is the frequency spacing between the FFT points of the spectrum. 6. Time domain points is the number of points in the time domain trace used for the FFT. The number of points doubles if the data is complex instead of real. See the time domain scaler description below. 7. First time point is the time of the first time domain point, where time zero is the trigger event. 8. Time spacing is the time spacing between the time domain points. The time spacing value doubles if the data is complex instead of real. See the time domain scaler description below. 9. Time domain returns a 1 if time domain is complex (I/Q) and complex data will be returned. It returns a 0 if the data is real. (raw ADC samples) When this value is 1 rather than 0 (complex vs. real data), the time domain points and the time spacing scalers both increase by a factor of two. 10. Scan time is the total scan time of the time domain trace used for the FFT. The total scan time = (time spacing) X (time domain points – 1) 11. Current average count is the current number of data measurements that have already been combined, in the averaging calculation. |
| 2, Service mode only | Returns the trace data of the log-magnitude versus time. (That is, the RF envelope.) |
| 3 | Returns the I and Q trace data. It is represented by I and Q pairs (in volts) versus time. |
| 4 | Returns spectrum trace data. That is, the trace of log-magnitude versus frequency. (The trace is computed using a FFT.) |
| 5, Service mode only | Returns the averaged trace data of log-magnitude versus time. (That is, the RF envelope.) |
| 6 | Not used. |
| 7 | Returns the averaged spectrum trace data. That is, the trace of the averaged log-magnitude versus frequency. |
| 8 | Not used. |
| 9, Service mode only | Returns a trace containing the shape of the FFT window. |

| n | Results Returned |
|---|--|
| 10, Service mode only | Returns trace data of the phase of the FFT versus frequency. |
| 11, cdma2000, 1xEV-DO, W-CDMA, Basic modes only | Returns linear spectrum trace data values in Volts RMS. |
| 12, cdma2000, 1xEV-DO, W-CDMA, Basic modes only | Returns averaged linear spectrum trace data values in Volts RMS. |

Timebase Frequency Measurement

The general functionality of **CONFigure**, **FETCh**, **MEASure**, and **READ** are described at the beginning of this section. See the **SENSe:TBFrequency** commands for more measurement related commands.

You must be in the Service mode to use these commands. Use **INSTrument:SELEct** to set the mode.

:CONFigure:TBFrequency

:INITiate:TBFrequency

:FETCh:TBFrequency [n] ?

:READ:TBFrequency [n] ?

:MEASure:TBFrequency [n] ?

Remarks: For auto adjustment of the internal frequency reference (10 MHz timebase), use the **CALibration:FREQuency:REFerence:AADJust** command after this measurement has been selected.

Front Panel

Access: **Measure, Timebase Freq**

After the measurement is selected, press **Restore Meas Defaults** to restore factory defaults.

Measurement Results Available

| n | Results Returned |
|------------------------|---|
| 0 | Not valid |
| n=1 (or not specified) | Returns scalar results: <ol style="list-style-type: none"> 1. RF input average amplitude 2. Average frequency error 3. Adjustment in process (returns 1 if an adjustment is being performed, returns 0 if no adjustment is in process) |
| 2 | Frequency error stripchart trace data. |

GMSK Transmit Band Spurs Measurement

This measures the spurious emissions in the transmit band relative to the channel power in the selected channel. You must be in the EDGE, GSM mode to use these commands. Use INSTRument:SElect to set the mode.

The general functionality of CONFigure, FETCh, MEASure, and READ are described at the beginning of this section. See the SENSE:TSPur commands for more measurement related commands.

:CONFigure:TSPur

:INITiate:TSPur

:FETCh:TSPur [n] ?

:READ:TSPur [n] ?

:MEASure:TSPur [n] ?

History: Version A.03.00 or later

Front Panel

Access: **Measure, Tx Band Spurs**

After the measurement is selected, press **Restore Meas Defaults** to restore factory defaults.

Measurement Results Available

| n | Results Returned |
|------------------------|---|
| 0 | Returns unprocessed I/Q trace data, as a series of trace point values, in volts. The I values are listed first in each pair, using the 0 through even-indexed values. The Q values are the odd-indexed values. |
| n=1 (or not specified) | Returns scalar results: <ol style="list-style-type: none"> 1. The worst spur's frequency difference from channel center frequency (in MHz) 2. The worst spur's amplitude difference from the limit (in dB) 3. The worst spur's amplitude difference from the mean transmit power (in dB) |
| 2 | Returns the current trace data (401 point real number comma separated list). |

GMSK Transmit Power Measurement

This measures the power in the channel. It compares the average power of the RF signal burst to a specified threshold value. You must be in the EDGE, GSM mode to use these commands. Use INSTRument:SElect to set the mode.

The general functionality of CONFigure, FETCh, MEASure, and READ are described at the beginning of this section. See the SENSE:TXPower commands for more measurement related commands.

```
:CONFigure:TXPower
:INITiate:TXPower
:FETCh:TXPower [n] ?
:READ:TXPower [n] ?
:MEASure:TXPower [n] ?
```

Front Panel

Access: **Measure, Transmit Power**

After the measurement is selected, press **Restore Meas Defaults** to restore factory defaults.

Measurement Results Available

| n | Results Returned |
|---|--|
| 0 | Returns unprocessed I/Q trace data, as a series of trace point values, in volts. The I values are listed first in each pair, using the 0 through even-indexed values. The Q values are the odd-indexed values. |

| n | Results Returned |
|------------------------|--|
| n=1 (or not specified) | <p>Returns the following scalar results:</p> <ol style="list-style-type: none"> 1. Sample time is a floating point number representing the time between samples when using the trace queries (n=0,2,etc). 2. Power is the mean power (in dBm) of the power above the threshold value. If averaging is on, the power is for the latest acquisition. 3. Power averaged is the threshold power (in dBm) for N averages, if averaging is on. An average consists of N acquisitions of data which represents the current trace. If averaging is off, the value of power averaged is the same as the power value. 4. Number of samples is the number of data points in the captured signal. This number is useful when performing a query on the signal (i.e. when n=0,2,etc.). 5. Threshold value is the threshold (in dBm) above which the power is calculated. 6. Threshold points is the number of points that were above the threshold and were used for the power calculation. 7. Maximum value is the maximum of the most recently acquired data (in dBm). 8. Minimum value is the minimum of the most recently acquired data (in dBm). |
| 2 | <p>Returns trace point values of the entire captured trace data. These data points are floating point numbers representing the power of the signal (in dBm). There are N data points, where N is the number of samples. The period between the samples is defined by the sample time.</p> |

Waveform (Time Domain) Measurement

For E4406A this measures the amplitude of your input signal with respect to the frequency. It provides spectrum analysis capability using FFT (fast Fourier transform) measurement techniques. You must select the appropriate mode using INSTRUMENT:SELEct, to use these commands.

For PSA this measures the amplitude of your input signal with respect to the frequency. It provides spectrum analysis capability using FFT (fast Fourier transform) measurement techniques. You must be in the Basic, cdmaOne, cdma2000, 1xEV-DO, W-CDMA, GSM (w/EDGE), NADC, or PDC mode to use these commands. Use INSTRUMENT:SELEct, to select the mode.

The general functionality of CONFigure, FETCh, MEASure, and READ are described at the beginning of this section. See the SENSE:WAVEform commands for more measurement related commands.

- :CONFigure:WAVEform
- :INITiate:WAVEform
- :FETCh:WAVEform [n] ?
- :READ:WAVEform [n] ?
- :MEASure:WAVEform [n] ?

Front Panel

Access: **Measure, Waveform (Time Domain)**

After the measurement is selected, press **Restore Meas Defaults** to restore factory defaults.

Measurement Results Available

| n | Results Returned |
|-------------------|--|
| 0 (see also 5) | Returns unprocessed I/Q trace data, as a series of trace point values, in volts. The I values are listed first in each pair, using the 0 through even-indexed values. The Q values are the odd-indexed values. |

| n | Results Returned |
|---|---|
| n=1 (or not specified) | <p>Returns the following scalar results:</p> <ol style="list-style-type: none"> 1. Sample time is a floating point number representing the time between samples when using the trace queries (n=0,2,etc). 2. Mean power is the mean power (in dBm). This is either the power across the entire trace, or the power between markers if the markers are enabled. If averaging is on, the power is for the latest acquisition. 3. Mean power averaged is the power (in dBm) for N averages, if averaging is on. This is either the power across the entire trace, or the power between markers if the markers are enabled. If averaging is on, the power is for the latest acquisition. If averaging is off, the value of the mean power averaged is the same as the value of the mean power. 4. Number of samples is the number of data points in the captured signal. This number is useful when performing a query on the signal (i.e. when n=0,2,etc.). 5. Peak-to-mean ratio has units of dB. This is the ratio of the maximum signal level to the mean power. Valid values are only obtained with averaging turned off. If averaging is on, the peak-to-mean ratio is calculated using the highest peak value, rather than the displayed average peak value. 6. Maximum value is the maximum of the most recently acquired data (in dBm). 7. Minimum value is the minimum of the most recently acquired data (in dBm). |
| 2 | <p>Returns trace point values of the entire captured signal envelope trace data. These data points are floating point numbers representing the power of the signal (in dBm). There are N data points, where N is the number of samples. The period between the samples is defined by the sample time.</p> |
| 3, Option B7C with cdma2000, W-CDMA, Basic modes only (E4406A only) | <p>Returns magnitude values of the time data in Volts peak.</p> |
| 4, Option B7C with cdma2000, W-CDMA, Basic modes only (E4406A only) | <p>Returns values of phase data in degrees.</p> |

READ Subsystem

The READ? commands are used with several other commands and are documented in the section on the “[MEASure Group of Commands](#)” on [page 347](#).

Initiate and Read Measurement Data

:READ:<measurement> [n] ?

A READ? query must specify the desired measurement. It causes a measurement to occur without changing any of the current settings, and returns any valid results. The code number n selects the kind of results that is returned. The available measurements and data results are described in the “[MEASure Group of Commands](#)” on [page 347](#).

SENSe Subsystem

These commands are used to set the instrument state parameters so that you can measure a particular input signal. Some SENSe commands are only for use with specific measurements found under the MEASURE key menu or the “MEASure Group of Commands” on page 347. The measurement must be active before you can use these commands.

The SCPI default for the format of any data output is ASCII. The format can be changed to binary with FORMat:DATA which transports faster over the bus.

Baseband I/Q Commands (E4406A only)

Baseband I/Q - Select I/Q Power Range

```
[[:SENSe]:POWER:IQ:RANGE[:UPPer] <power> [DBM] | DBMV | W
```

```
[[:SENSe]:POWER:IQ:RANGE[:UPPer] ?
```

Selects maximum total power expected from unit under test at test port when I or Q port is selected.

Range: For 50 Ohms:

13.0, 7.0, 1.0, or -5.1 dBm
60.0, 54.0, 48.0, or 41.9 dBmV
0.02, 0.005, 0.0013, or 0.00031 W

For 600 Ohms:

2.2, -3.8, -9.8, or -15.8 dBm
60.0, 54.0, 48.0, or 41.9 dBmV
0.0017, 0.00042, 0.0001, or 0.000026 W

For 1 M Ohm:

Values for 1 M Ohm vary according to selected reference impedance.

Default Units: DBM

Remarks: You must be in the Basic, W-CDMA, cdma2000, or EDGE with GSM mode to use this command. Use INSTRument:SElect to set the mode.

History: Added revision A.05.00 for B, WC, C2
Added revision A.06.00 for E

Baseband I/Q - Select I/Q Voltage Range

```
[[:SENSe]:VOLTage:IQ:RANGE[:UPPer] <level>
```

`[:SENSE] :VOLTage:IQ:RANGE [:UPPer] ?`

Selects upper voltage range when I or Q port is selected. This setting helps set the gain which is generated in the variable gain block of the baseband IQ board to improve dynamic range.

Range: 1.0, 0.5, 0.25, or 0.125 volts

Default Units: V

Remarks: You must be in the Basic, W-CDMA, cdma2000, or EDGE with GSM mode to use this command. Use `INSTRument:SElect` to set the mode.

History: Added revision A.05.00 for B, WC, C2
Added revision A.06.00 for E

Channel Commands

Select the ARFCN—Absolute RF Channel Number

`[:SENSe] :CHANnel :ARFCn | RFCHannel <integer>`

`[:SENSe] :CHANnel :ARFCn | RFCHannel ?`

Sets the analyzer to a frequency that corresponds to the ARFCN (Absolute RF Channel Number).

Factory Preset: 38

Range: 0 to 124, and 975 to 1023 for E-GSM
 1 to 124 for P-GSM
 0 to 124, and 955 to 1023 for R-GSM
 512 to 885 for DCS1800
 512 to 810 for PCS1900
 259 to 293 for GSM450
 306 to 340 for GSM480
 438 to 511 for GSM700
 128 to 251 for GSM850

Remarks: You must be in the GSM, EDGE mode to use this command. Use INSTRument:SElect to set the mode.

Global to the current mode.

History: E4406A:
 Version A.03.00 or later

Front Panel

Access: **FREQUENCY Channel, ARFCN**

Select the Lowest ARFCN

`[:SENSe] :CHANnel :ARFCn | RFCHannel :BOTTom`

Sets the analyzer to the frequency of the lowest ARFCN (Absolute RF Channel Number) of the selected radio band.

Factory Preset: 975 for E-GSM

1 for P-GSM

955 for R-GSM

512 for DCS1800

512 PCS1900

259 GSM450

306 GSM480

438 GSM700

128 GSM850

Remarks: You must be in the GSM, EDGE mode to use this command. Use INSTRUMENT:SElect to set the mode.
Global to the current mode.

History: E4406A:
Version A.03.00 or later

Front Panel
Access: **FREQUENCY Channel, BMT Freq**

Select the Middle ARFCN

[:SENSE] :CHANnel :ARFCn | RFChannel :MIDDLE

Sets the analyzer to the frequency of the middle ARFCN (Absolute RF Channel Number) of the selected radio band.

Factory Preset: 38 for E-GSM
63 for P-GSM
28 for R-GSM
699 for DCS1800
661 for PCS1900
276 for GSM450
323 for GSM480
474 for GSM 700
189 for GSM850

Remarks: You must be in the GSM, EDGE mode to use this command. Use INSTRUMENT:SElect to set the mode.
Global to the current mode.

History: E4406A:
Version A.03.00 or later

Front Panel
Access: **FREQUENCY Channel, BMT Freq**

Select the Highest ARFCN

`[:SENSe] :CHANnel :ARFCn | RFCHannel :TOP`

Sets the analyzer to the frequency of the highest ARFCN (Absolute RF Channel Number) of the selected radio band.

Factory Preset: 124 for E-GSM

124 for P-GSM

124 for R-GSM

885 for DCS1800

810 for PCS1900

293 for GSM450

340 for GSM480

511 for GSM700

251 for GSM850

Remarks: You must be in the GSM, EDGE mode to use this command. Use INSTRument:SElect to set the mode.

Global to the current mode.

History: E4406A:
Version A.03.00 or later

Front Panel

Access: **FREQUENCY Channel, BMT Freq**

Channel Burst Type

`[:SENSe] :CHANnel :BURSt NORMal | SYNC | ACCess`

`[:SENSe] :CHANnel :BURSt?`

Sets the burst type that the analyzer searches for, and to which it will synchronize. This only applies with normal burst selected.

NORMal: Traffic Channel (TCH) and Control Channel (CCH)

SYNC: Synchronization Channel (SCH)

ACCess: Random Access Channel (RACH)

Remarks: You must be in the GSM, EDGE mode to use this command. Use INSTRument:SElect to set the mode.

Global to the current mode.

Front Panel

Access: **FREQUENCY Channel, Burst Type**

Time Slot number

`[:SENSE] :CHANnel :SLOT <integer>`

`[:SENSE] :CHANnel :SLOT?`

Selects the slot number that you want to measure.

In GSM, EDGE mode the measurement frame is divided into the eight expected measurement timeslots.

Factory Preset: 0 for GSM, EDGE, PDC mode

1 for NADC mode

Range: 0 to 5 for PDC mode

1 to 6 for NADC mode

0 to 7 for GSM, EDGE mode

Remarks: You must be in GSM, EDGE, NADC, or PDC mode to use this command. Use INSTRument:SElect to set the mode.

Front Panel

Access: **Mode Setup, Radio, Frequency Hopping Repetition Factor**

Time Slot Auto

`[:SENSE] :CHANnel :SLOT :AUTO OFF | ON | 0 | 1`

`[:SENSE] :CHANnel :SLOT :AUTO?`

Selects auto or manual control for slot searching. The feature is only supported in external and frame trigger source modes. In external trigger mode when timeslot is set on, the demodulation measurement is made on the nth timeslot specified by the external trigger point + n timeslots, where n is the selected timeslot value 0 to 7. In frame trigger mode when timeslot is set on, then the demodulation measurement is only made on the nth timeslot specified by bit 0 of the frame reference burst + n timeslots, where n is the selected timeslot value 0 to 7 and where the frame reference burst is specified by the Ref Burst and Ref TSC (Std) combination.

Factory Preset: ON, for NADC, PDC mode

OFF, for GSM, EDGE mode

Remarks: The command is only applicable for mobile station testing, device = MS.

You must be in GSM, EDGE, NADC, or PDC mode to use this command. Use INSTRument:SElect to set the

mode.

History: E4406A:
Added GSM mode, version A.03.00 or later

Training Sequence Code (TSC)

`[:SENSe] :CHANnel:TSCode <integer>`

`[:SENSe] :CHANnel:TSCode?`

Sets the training sequence code to search for, with normal burst selected and TSC auto set to off.

Factory Preset: 0

Range: 0 to 7

Remarks: Global to the current mode.

You must be in the GSM, EDGE mode to use this command. Use INSTRument:SElect to set the mode.

History: E4406A:
Version A.03.00 or later

Front Panel

Access: **FREQUENCY Channel, TSC (Std)**

Training Sequence Code (TSC) Auto

`[:SENSe] :CHANnel:TSCode:AUTO OFF|ON|0|1`

`[:SENSe] :CHANnel:TSCode:AUTO?`

Selects auto or manual control for the training sequence code (TSC) search. With auto on, the measurement is made on the first burst found to have one of the valid TSCs in the range 0 to 7 (that is, normal bursts only). With auto off, the measurement is made on the 1st burst found to have the selected TSC.

Factory Preset: AUTO

Remarks: Global to the current mode.

You must be in the GSM, EDGE mode to use this command. Use INSTRument:SElect to set the mode.

Front Panel

Access: **FREQUENCY Channel, TSC (Std)**

Signal Corrections Commands

Correction for BTS RF Port External Attenuation

`[:SENSE] :CORRection:BTS [:RF] :LOSS <rel_power>`

`[:SENSE] :CORRection:BTS [:RF] :LOSS?`

Sets the correction equal to the external attenuation used when measuring base transmission stations.

Factory Preset: 0.0 dB

Range: -50 to 100.0 dB for GSM, EDGE
 -100.0 to 100.0 dB for cdma2000, W-CDMA, 1xEV-DO

Default Unit: dB

Remarks: Global to the current mode.

You must be in the GSM, EDGE, cdma2000, W-CDMA, or 1xEV-DO mode to use this command. Use INSTRUMENT:SElect to set the mode.

Correction for MS RF Port External Attenuation

`[:SENSE] :CORRection:MS [:RF] :LOSS <rel_power>`

`[:SENSE] :CORRection:MS [:RF] :LOSS?`

Sets the correction equal to the external attenuation used when measuring mobile stations.

Factory Preset: 0.0 dB

Range: -50 to 100.0 dB for cdmaOne, GSM, EDGE, iDEN
 -100.0 to 100.0 dB for cdma2000, W-CDMA, 1xEV-DO
 -50.0 to 50.0 dB for NADC, PDC

Default Unit: dB

Remarks: For E4406A you must be in the cdmaOne, GSM, EDGE (w/GSM), cdma2000, W-CDMA, iDEN, NADC, PDC, or 1xEV-DO mode to use this command. Use INSTRUMENT:SElect to set the mode.

For PSA you must be in the cdmaOne, GSM (w/EDGE), cdma2000, W-CDMA, NADC, PDC, or 1xEV-DO mode to use this command. Use INSTRUMENT:SElect to set the mode.

Value is global to the current mode.

EDGE Error Vector Magnitude Measurement

Commands for querying the EDGE error vector magnitude measurement results and for setting to the default values are found in the “MEASure Group of Commands” on page 347. The equivalent front panel keys for the parameters described in the following commands, are found under the **Meas Setup** key, after the measurement has been selected from the **MEASURE** key menu.

History: For E4406A: the EEVM measurement was added in version A.04.00.

EDGE Error Vector Magnitude—Average Count

```
[ :SENSe ] :EEVM:AVERAge:COUNT <integer>
```

```
[ :SENSe ] :EEVM:AVERAge:COUNT?
```

Sets the number of data acquisitions that are averaged. After the specified number of average counts, the average mode (termination control) setting determines the average action.

Factory Preset: 10

Range: 1 to 10,000 for VSA, PSA

Remarks: You must be in GSM, EDGE mode to use this command. Use INSTRument:SElect to set the mode.

History: Added version A.04.00 and later

EDGE Error Vector Magnitude—Averaging State

```
[ :SENSe ] :EEVM:AVERAge [ :STATe ] OFF | ON | 0 | 1
```

```
[ :SENSe ] :EEVM:AVERAge [ :STATe ] ?
```

Turns average on or off.

Factory Preset: ON for VSA, PSA

Remarks: You must be in GSM, EDGE mode to use this command. Use INSTRument:SElect to set the mode.

EDGE Error Vector Magnitude—Averaging Termination Control

```
[ :SENSe ] :EEVM:AVERAge:TCONtrol EXPonential | REPeat
```

```
[ :SENSe ] :EEVM:AVERAge:TCONtrol?
```

Selects the type of termination control used for the averaging function.

This determines the averaging action after the specified number of data acquisitions (average count) is reached.

EXPOnential - After the average count has been reached, each successive data acquisition is exponentially weighted and combined with the existing average.

REPeat – After reaching the average count, the averaging is reset and a new average is started.

Factory Preset: EXPOnential

Remarks: You must be in GSM, EDGE mode to use this command.
Use INSTRument:SELEct to set the mode.

EDGE Error Vector Magnitude—Polar Modulation Alignment

`[:SENSE] :EEVM:BSYNc:PMODulation:ALIGNment OFF | ON | 0 | 1`

`[:SENSE] :EEVM:BSYNc:PMODulation:ALIGNment?`

When polar modulation is selected for Burst Sync, the timing offset of the amplitude path to the phase path is always calculated. This command sets whether the timing offset is used for compensation in the EVM calculation.

Factory Preset: Off

Saved State: Yes

Remarks: Select SENSE:EEVM:BSYNc:SOURce PMODulation.
You must be in EDGE mode to use this command. Use INSTRument:SELEct to set the mode.

History: PSA: added in version A.08.00 and later.
VSA: added in version A.09.00 and later.

Front Panel

Access: **Meas Setup**

EDGE Error Vector Magnitude—Burst Synchronization Source

`[:SENSE] :EEVM:BSYNc:SOURce
RFBurst | PMODulation | TSEQuence | NONE`

`[:SENSE] :EEVM:BSYNc:SOURce?`

Selects the method of synchronizing the measurement to the bursts.

RFBurst – The burst synchronization approximates the start and stop of the useful part of the burst without demodulation of the burst. This type of synchronization has a frequency lock range of up

to 9 kHz and allows you to demodulate RF bursts that do not have a training sequence.

PMODulation (Polar Modulation) – The burst synchronization performs a demodulation of the burst and determines the start and stop of the useful part of the burst. The instrument searches the training sequence on the amplitude path and phase path in polar modulation trying to sync (analyzing the time delay adjustment between the paths).

TSEquence (Training Sequence) – The burst synchronization performs a demodulation of the burst and determines the start and stop of the useful part of the burst based on the midamble training sync sequence. This type of synchronization provides better noise immunity but has a smaller frequency lock range (~200 Hz).

None – The measurement is performed without searching burst.

Factory Preset: TSEquence

Remarks: You must be in GSM, EDGE mode to use this command. Use INSTRUMENT:SElect to set the mode.

Example: EEVM:BYSN:SOUR PMOD

History: PSA: changed in version A.08.00 and later.
VSA: changed in version A.09.00 and later.

Front Panel

Access: **Meas Setup, Burst Sync**

EDGE Error Vector Magnitude—Droop Compensation

[:SENSe] :EEVM:DRoOp OFF | ON | 0 | 1

[:SENSe] :EEVM:DRoOp?

Turns droop compensation on or off. Droop compensation corrects amplitude variations across a burst. You may want to turn off this compensation so you can see the changes in the measured magnitude error. Droop can result from signal impairments such as a power amplifier problem.

Factory Preset: ON

Range: OFF, ON

Remarks: You must be in GSM, EDGE mode to use this command. Use INSTRUMENT:SElect to set the mode.

EDGE Error Vector Magnitude—Activate Extreme Limits

`[:SENSE] :EEVM:ELIMit OFF | ON | 0 | 1`

`[:SENSE] :EEVM:ELIMit?`

Turns EEVM extreme limits on or off. GSM 5.05 provides two sets of limits, called “Normal” and “Extreme”. Select “ON” to turn the extreme limits on. Select “OFF” to return limits to the “Normal” parameter after the “Extreme” limits have been selected.

Factory Preset: OFF

Range: OFF, ON

Remarks: You must be in GSM, EDGE mode to use this command.
Use INSTRUMENT:SELEct to set the mode.

EDGE Error Vector Magnitude—Freq Error Tolerance Range

`[:SENSE] :EEVM:FERRor:TRANge WIDE | NORMAl`

`[:SENSE] :EEVM:FERRor:TRANge?`

Name: Freq Error Tolerance Range

Key Path: **Meas Setup, More 1 of 2**

Factory Preset: WIDE

State Saved: Saved in instrument state.

Range: WIDE | NORMAl

Example: `:SENSE:EEVM:FERRor:TRANge NORMAl`

EDGE Error Vector Magnitude—Points/Symbol Dots

`[:SENSE] :EEVM:SDOTs [:STATe] OFF | ON | 0 | 1`

`[:SENSE] :EEVM:SDOTs [:STATe] ?`

Activates or deactivates points/symbol dot display in polar view.

Factory Preset: ON

Range: OFF, ON

Remarks: You must be in GSM, EDGE mode to use this command.
Use INSTRUMENT:SELEct to set the mode.

EDGE Error Vector Magnitude—Points/Symbol Dots

`[:SENSe] :EEVM:TRACe:SDOTs <integer>`

`[:SENSe] :EEVM:TRACe:SDOTs?`

Selects the number of dots that are displayed for each symbol.

Factory Preset: 5

Range: 1 to 5

Remarks: You must be in GSM, EDGE mode to use this command.
Use INSTRument:SElect to set the mode.

EDGE Error Vector Magnitude—Trigger Source

`[:SENSe] :EEVM:TRIGger:SOURce`

`EXTErnal [1] | EXTErnal2 | FRAME | IF | IMMEDIATE | RFBurst`

`[:SENSe] :EEVM:TRIGger:SOURce?`

Selects the trigger source used to control the data acquisitions.

EXTErnal 1 – front panel external trigger input

EXTErnal 2 – rear panel external trigger input

IF – internal IF envelope (video) trigger

IMMEDIATE – the next data acquisition is immediately taken, capturing the signal asynchronously (also called free run)

FRAME – internal frame trigger from front panel input

RFBurst – wideband RF burst envelope trigger that has automatic level control for periodic burst signals

Factory Preset: IMMEDIATE for VSA,PSA BS

RFBurst for VSA,PSA MS

Remarks: You must be in GSM, EDGE mode to use this command.
Use INSTRument:SElect to set the mode.

NOTE

Option B7E: RF Comms Hardware has at least three possible part numbers. Press **System, More, Show Hdwr** to show your instrument's RF Comms Hardware and view the part number. If the part number is E4401-60087 (the original version), the RF Burst trigger source is not available with this measurement, and the default is **EXTErnal**.

EDGE Error Vector Magnitude—Type of Test Condition

`[:SENSe] :EEVM:TYPE:LIMit NORMAl | EXTREme`

`[:SENSe] :EEVM:TYPE:LIMit?`

| | |
|-----------------|---|
| Name: | Type of Test Condition |
| Key Path: | Meas Setup, Limit |
| Factory Preset: | NORMal |
| State Saved: | Saved in instrument state. |
| Range: | NORMal, EXTReMe |
| Example: | <code>[:SENSe] :EEVM:TYPE:LIMit NORMal</code> |

EDGE Output RF Spectrum Measurement

Commands for querying the EDGE output RF spectrum measurement results and for setting to the default values are found in the “[MEASure Group of Commands](#)” on page 347. The equivalent front panel keys for the parameters described in the following commands, are found under the **Meas Setup** key, after the **EDGE Output RF Spectrum** measurement has been selected from the **MEASURE** key menu.

History: For E4406A: added in version A.04.00.

EDGE Output RF Spectrum—Number of Bursts Averaged

```
[ :SENSe ] :EORFspectr:AVERAge:COUNT <integer>
```

```
[ :SENSe ] :EORFspectr:AVERAge:COUNT?
```

Set the number of bursts that are averaged. For the output RF spectrum due to switching transients, it is more accurate to consider this the number of frames that are measured. After the specified number of bursts (average counts), the averaging mode (termination control) setting determines the averaging action.

Factory Preset: 20

Range: 1 to 10,000

Remarks: You must be in GSM, EDGE mode to use this command.
Use INSTRument:SElect to set the mode.

EDGE Output RF Spectrum—Fast Averaging

```
[ :SENSe ] :EORFspectr:AVERAge:FAST[:STATe] OFF|ON|0|1
```

```
[ :SENSe ] :EORFspectr:AVERAge:FAST[:STATe] ?
```

Make the measurement faster by using an averaging technique different from that defined by the standard. A valid average can be obtained by measuring the power in half the normal number of bursts by using 50% - 90% of the burst, 10% - 50% of the burst and excluding the midamble.

This faster averaging is only done when averaging is on and only the modulation results are being measured. If both modulation and switching transients results are being measured, then the measurement uses the default averaging.

Factory Preset: ON

Remarks: You must be in GSM, EDGE mode to use this command.
Use INSTRument:SElect to set the mode.

EDGE Output RF Spectrum—Averaging Type for Modulation Spectrum

```
[ :SENSe] :EORFspectr:AVERAge:MODUlation:TYPE LOG|RMS
```

```
[ :SENSe] :EORFspectr:AVERAge:MODUlation:TYPE?
```

Select the type of averaging for measuring the modulation spectrum. This is an advanced control that normally does not need to be changed. Setting this to a value other than the factory default, may cause invalid measurement results.

LOG - The log of the power is averaged. (This is also known as video averaging.)

RMS - The power is averaged, providing the rms of the voltage.

Factory Preset: LOG

Remarks: You must be in GSM, EDGE mode to use this command. Use INSTRUMENT:SElect to set the mode.

EDGE Output RF Spectrum—Averaging Control

```
[ :SENSe] :EORFspectr:AVERAge[:STATe] OFF|ON|0|1
```

```
[ :SENSe] :EORFspectr:AVERAge[:STATe]?
```

Turn averaging on or off.

Factory Preset: ON

Remarks: You must be in GSM, EDGE mode to use this command. Use INSTRUMENT:SElect to set the mode.

EDGE Output RF Spectrum—Resolution BW for the Modulation Spectrum at the Carrier

```
[ :SENSe] :EORFspectr:BANDwidth|BWIDth[:RESolution]  
:MODUlation:CARRier <freq>
```

```
[ :SENSe] :EORFspectr:BANDwidth|BWIDth[:RESolution]  
:MODUlation:CARRier?
```

Selects the resolution bandwidth for measuring the carrier when measuring spectrum due to modulation and wideband noise.

This parameter is only used with the Standard or Short lists, and not with the Custom list.

Factory Preset: 30 kHz

Range: 1 kHz to 5 MHz

Default Unit: Hz

Remarks: You must be in GSM, EDGE mode to use this command.
Use INSTRument:SElect to set the mode.

EDGE Output RF Spectrum—Resolution BW For Modulation At Close Offsets

```
[[:SENSe]:EORFspectr:BANDwidth|BWIDth[:RESolution]  
:MODulation:OFFSet:CLOSe <freq>
```

```
[[:SENSe]:EORFspectr:BANDwidth|BWIDth[:RESolution]  
:MODulation:OFFSet:CLOSe?
```

Set the resolution bandwidth used for the spectrum due to modulation part of the EORF measurement for offset frequencies less than 1800 kHz.

This parameter is only used with the Standard or Short lists, and not with the Custom list.

Factory Preset: 30 kHz

Range: 1 kHz to 5 MHz

Default Unit: Hz

Remarks: You must be in GSM, EDGE mode to use this command.
Use INSTRument:SElect to set the mode.

EDGE Output RF Spectrum—Resolution BW for Modulation at Far Offsets

```
[[:SENSe]:EORFspectr:BANDwidth|BWIDth[:RESolution]  
:MODulation:OFFSet:FAR <freq>
```

```
[[:SENSe]:EORFspectr:BANDwidth|BWIDth[:RESolution]  
:MODulation:OFFSet:FAR?
```

Set the resolution bandwidth used for the spectrum due to modulation part of the EORF measurement for offset frequencies greater than or equal to 1800 kHz.

This parameter is only used with the Standard or Short lists, and not with the Custom list.

Factory Preset: 100 kHz

Range: 1 kHz to 5 MHz

Default Unit: Hz

Remarks: You must be in GSM, EDGE mode to use this command.
Use INSTRument:SElect to set the mode.

EDGE Output RF Spectrum—Resolution BW for the Switching Transient Spectrum at the Carrier

```
[ :SENSE ] :EORFspectr: BANDwidth | BWIDth [ :RESolution ]
:SWITChing: CARRier <freq>
```

```
[ :SENSE ] :EORFspectr: BANDwidth | BWIDth [ :RESolution ]
:SWITChing: CARRier?
```

Selects the resolution bandwidth for the carrier when measuring spectrum due to switching transients.

This parameter is only used with the Standard or Short lists, and not with the Custom list.

Factory Preset: 300 kHz

Range: 1 kHz to 5 MHz

Default Unit: Hz

Remarks: You must be in GSM, EDGE mode to use this command.
Use INSTRument:SElect to set the mode.

EDGE Output RF Spectrum—Resolution BW For Switching Transients At Close Offsets

```
[ :SENSE ] :EORFspectr: BANDwidth | BWIDth [ :RESolution ]
:SWITChing: OFFSet: CLOSe <freq>
```

```
[ :SENSE ] :EORFspectr: BANDwidth | BWIDth [ :RESolution ]
:SWITChing: OFFSet: CLOSe?
```

Set the resolution bandwidth used for the spectrum due to switching transients part of the EORF measurement for offset frequencies less than 1800 kHz.

This parameter is only used with the Standard or Short lists, and not with the Custom list.

Factory Preset: 30 kHz

Range: 1 kHz to 5 MHz

Default Unit: Hz

Remarks: You must be in GSM, EDGE mode to use this command.
Use INSTRument:SElect to set the mode.

EDGE Output RF Spectrum—Resolution BW For Switching Transients At Far Offsets

```
[ :SENSE ] :EORFspectr: BANDwidth | BWIDth [ :RESolution ]
:SWITChing: OFFSet: FAR <freq>
```

```
[ :SENSe ] :EORFspectr:BAWdwidth | BWIDth [ :RESolution ]  
:SWITching:OFFSet:FAR?
```

Set the resolution bandwidth used for the spectrum due to switching transients part of the EORF measurement for offset frequencies greater than or equal to 1800 kHz.

This parameter is only used with the standard or short lists, and not with the custom list.

Factory Preset: 30 kHz

100 kHz

Range: 1 kHz to 5 MHz

Default Unit: Hz

Remarks: You must be in GSM, EDGE mode to use this command.
Use INSTRument:SElect to set the mode.

EDGE Output RF Spectrum—Break Frequency

```
[ :SENSe ] :EORFspectr:BFRequency <freq>
```

```
[ :SENSe ] :EORFspectr:BFRequency?
```

LP: keep the ORFS meas tracking with this command.

Set the direct time break frequency. An FFT measurement method is used for offsets below this break frequency. The direct time measurement method is used for offsets above the break frequency. See the Making EDGE (with GSM) Measurement chapter for more information about these two methods.

Factory Preset: 600 kHz

Range: 0 kHz to 775 kHz

Default Unit: Hz

Remarks: You must be in GSM, EDGE mode to use this command.
Use INSTRument:SElect to set the mode.

Front Panel

Access: **Meas Setup, Advanced, Direct Time Break Freq**

EDGE Output RF Spectrum—Peak Detection mode

```
[ :SENSe ] :EORFSpectrum:DETEctor:SWITching:FAST [ :STATE ]  
OFF | ON | 0 | 1
```

```
[ :SENSe ] :EORFSpectrum:DETEctor:SWITching?
```

Sets the detection mode to “fast peak”. This setting functions when

“measurement type” selected is Switching or Switching & Modulation.

Factory Preset: On

Remarks: You must be in the GSM or EDGE mode to use this command. Use INSTRUMENT:SElect to set the mode.

Front Panel

Access: **Meas Setup, More, Advanced**

State Saved: Saved in Instrument State

EDGE ORFS - Meas Method

```
[ :SENSE ] :EORFspectr:MEASure MULTiple | SINGLE | SWEPT
```

```
[ :SENSE ] :EORFspectr:MEASure?
```

| | |
|-----------------------------|---|
| Mode: | GSM |
| Key Path: | Meas Setup |
| Factory Preset: | MULTiple, |
| State Saved: | Saved in instrument state. |
| Range: | Multi-Offset Single Offset (Examine) Swept |
| Dependencies and Couplings: | Swept choice is available only if Meas Type is Modulation. Otherwise, the Swept choice is grayed out. If Swept is selected and Meas Type is not Modulation, the measurement algorithm internally assumes that Meas Method is Multi-Offset. |
| Example: | :SENSE:EORFspectr:MEASure MULTiple |

EDGE ORFS - Custom Modulation Apply Limit Level Offsets

```
[ :SENSE ] :EORFspectr:LIST:MODulation:APPLY  
RELative | BOTH | ABSolute { , RELative | BOTH | ABSolute }
```

```
[ :SENSE ] :EORFspectr:LIST:MODulation:APPLY?
```

| | |
|-----------|--|
| Mode: | GSM |
| Key Path: | Meas Setup |
| Default: | BOTH, BOTH, BOTH, BOTH, BOTH, BOTH, BOTH, BOTH, BOTH, BOTH, BOTH, BOTH, BOTH, BOTH, BOTH |

| | |
|---------------|--|
| State Saved: | Saved in instrument state. |
| Range: | Rel Both Abs |
| Example: | :SENSe:EORFspectr:LIST:MODulation:APPLY RELative, RELative, RELative |
| Array Length: | Any number from 1 to 15 is acceptable as long as the following arrays have the same number of elements: Custom Switching Offset Frequency Custom Switching Resolution Band Width Custom Switching Relative Limit Level Offsets Custom Switching Absolute Limit Level Offsets Custom Switching Apply Limit Level Offsets |

EDGE Output RF Spectrum—Define Custom Modulation Resolution Bandwidth List

```
[[:SENSe]:EORFspectr:LIST:MODulation:BANDwidth|BWIDth  
<res bw>{,<res bw>}
```

```
[[:SENSe]:EORFspectr:LIST:MODulation:BANDwidth|BWIDth?
```

Define the custom set of resolution bandwidths for the modulation spectrum part of the EORF measurement. The first bandwidth specified is for the carrier. Each resolution bandwidth in this list corresponds to an offset frequency in the modulation offset frequency list. The number of items in each of these lists needs to be the same.

Factory Preset: Same as standard list

Range: 1 kHz to 5 MHz

Default Unit: Hz

Remarks: This command is only valid if SENS:EORF:MEAS is set to multiple and the custom list type is selected with SENS:EORF:LIST:SEL CUST.

You must be in GSM, EDGE mode to use this command.
Use INSTRument:SElect to set the mode.

EDGE ORFS - Custom Modulation State

```
[[:SENSe]:EORFspectr:LIST:MODulation[:FREQUENCY] <offset  
freq>{,<offset freq>}
```

```
[[:SENSe]:EORFspectr:LIST:MODulation[:FREQUENCY] ?
```



```
[ :SENSe ] :EORFspectr:LIST:MODulation:STATE
OFF | ON | 0 | 1 { , OFF | ON | 0 | 1 }
```

```
[ :SENSe ] :EORFspectr:LIST:MODulation:STATE?
```

| | |
|-----------------------|--|
| Mode: | GSM |
| Key Path: | Meas Setup |
| Active Function Text: | Offset Freq |
| Default Terminator: | Hz kHz MHz GHz |
| Factory Presets | |
| Frequency: | 0.0, 1.0e5, 2.0e5, 2.5e5, 4.0e5, 6.0e5, 8.0e5, 1.0e6, 1.2e6, 1.4e6, 1.6e6, 1.8e6, 3.0e6, 6.0e6 |
| State: | 1, 1, 1, 1, 1, 1, 1, 1, 1, 1, 1, 1, 1, 1 |
| State Saved: | Saved in instrument state. |
| SCPI Resolution: | 1.0 Hz |
| Example: | :SENSe:EORFspectr:LIST:MODulation:FREQu ency 0.0, 1.0e5, 2.0e5 :SENSe:EORFspectr:LIST:MODulation:STATE ON, ON, ON |
| Array Length: | Any number from 1 to 15 is acceptable as long as the following arrays have the same number of elements: Custom Switching Offset Frequency Custom Switching Resolution Band Width Custom Switching Relative Limit Level Offsets Custom Switching Absolute Limit Level Offsets Custom Switching Apply Limit Level Offsets |

EDGE ORFS - Custom Modulation Absolute Limit Level Offsets

```
[ :SENSe ] :EORFspectr:LIST:MODulation:LOFFset:ABSolute
<level> { , <level> }
```

```
[ :SENSe ] :EORFspectr:LIST:MODulation:LOFFset:ABSolute?
```

| | |
|-----------|-------------------|
| Mode: | GSM |
| Key Path: | Meas Setup |
| Unit: | dB |

| | |
|---------------|--|
| Default: | 0.0 |
| State Saved: | Saved in instrument state. |
| Resolution: | 0.1 dB |
| Example: | :SENSe:EORFspectr:LIST:MODulation:LOFFset: ABSolute 0.0, -2.0, -5.0 |
| Array Length: | Any number from 1 to 15 is acceptable as long as the following arrays have the same number of elements: Custom Switching Offset Frequency Custom Switching Resolution Band Width Custom Switching Relative Limit Level Offsets Custom Switching Absolute Limit Level Offsets Custom Switching Apply Limit Level Offsets |

EDGE Output RF Spectrum—Define Custom Modulation Relative Limit Level Offsets

```
[[:SENSe]:EORFspectr:LIST:MODulation:LOFFset  
[:RCARrier] <level>{,<level>}
```

```
[[:SENSe]:EORFspectr:LIST:MODulation:LOFFset [:RCARrier]?
```

Define the custom set of level offsets for the modulation spectrum part of the EORF measurement. This allows you to modify the standard limits by adding a delta amplitude value to them. The first level offset specified must be 0 dB for the carrier. Each level offset in this list corresponds to an offset frequency in the modulation offset frequency list. The number of items in each of these lists needs to be the same.

Example: EORF:LIST:MOD:FREQ 0,300e3,1.3e6,2.0e6
 Sets custom offset freqs: 300 kHz, 1.3 MHz, 2 MHz
 EORF:LIST:MOD:BAND 30e3,30e3,30e3,100e3
 Sets corresponding RBWs: 30 kHz, 30 kHz, 100 kHz
 EORF:LIST:MOD:LOFFset 0,-5,3,5
 Assume the power level of the signal is -43 dBm, then
 the standard limits for these three offsets are: -42 dBc,
 -72 dBc, -75 dBc respectively. The LOFFset command
 adjusts these limits to: -47 (-42-5) dBc, -70 (-73+3) dBc,
 -70 (-75+5) dBc.

Factory Preset: 0 dB level offsets (limits remain the same as the standards)

Range: 0 to 50 dB
 Default Unit: dB
 Remarks: This command is only valid if SENS:EORF:MEAS is set to multiple and the custom list type is selected with SENS:EORF:LIST:SEL CUST.
 You must be in GSM, EDGE mode to use this command. Use INSTRument:SElect to set the mode.

EDGE Output RF Spectrum—Offset Frequency List

```
[ :SENSe ] :EORFspectr :LIST :SElect CUSTom | SHORt | STANdard  

[ :SENSe ] :EORFspectr :LIST :SElect ?
```

Select the list of settings that are used to make the EORF measurement. This specifies standard or customized lists and short lists. The lists contain the offset frequencies (and bandwidths) that are used for the modulation spectrum and transient spectrum parts of the EORF measurement.

CUSTom - Uses the four user-defined lists that specify:

- Offset frequencies for modulation spectrum measurement
- Corresponding resolution bandwidths for each of the modulation offset frequencies
- Offset frequencies for switching transient spectrum measurement
- Corresponding resolution bandwidths for each of the switching transient offset frequencies

SHORt - A shortened list of the offset frequencies specified in the EDGE Standards. It uses two internal offset frequency lists, one for modulation spectrum and the other for switching transient spectrum. These offset frequencies cannot be changed, but the resolution bandwidths can be changed by other commands in the SENSe:EORFpectr subsystem.

STANdard - The complete list of the offset frequencies specified in the EDGE Standards, except for those offsets greater than 6 MHz. It uses two internal offset frequency lists, one for modulation spectrum and the other for switching transient spectrum. These offset frequencies cannot be changed, but the resolution bandwidths can be changed by other commands in the SENSe:EORFpectr subsystem.

Factory Preset: SHORt

Remarks: This command is only valid if SENS:EORF:MEAS is set to multiple.
 If you change the number of custom offsets then the number of offset bandwidths, frequencies and level

offsets must also be changed.

You must be in GSM, EDGE mode to use this command.
Use INSTRument:SELEct to set the mode.

EDGE ORFS - Custom Switching Apply Limit Level Offsets

```
[ :SENSe ] :EORFspectr:LIST:SWITching:APPLy  
RELative | BOTH | ABSolute { , RELative | BOTH | ABSolute }
```

```
[ :SENSe ] :EORFspectr:LIST:SWITching:APPLy?
```

| | |
|---------------|--|
| Mode: | GSM |
| Key Path: | Meas Setup |
| Default: | BOTH, BOTH, BOTH, BOTH, BOTH, BOTH, BOTH, BOTH, BOTH, BOTH, BOTH, BOTH, BOTH, BOTH, BOTH |
| State Saved: | Saved in instrument state. |
| Range: | Rel Both Abs |
| Example: | :SENSe:EORFspectr:LIST:SWITching:APPLy RELative, RELative, RELative |
| Array Length: | Any number from 1 to 15 is acceptable as long as the following arrays have the same number of elements: Custom Switching Offset Frequency Custom Switching Resolution Band Width Custom Switching Relative Limit Level Offsets Custom Switching Absolute Limit Level Offsets Custom Switching Apply Limit Level Offsets |

EDGE ORFS - Custom Switching Absolute Limit Level Offsets

```
[ :SENSe ] :EORFspectr:LIST:SWITching:LOFFset:ABSolute  
<level> { , <level> }
```

```
[ :SENSe ] :EORFspectr:LIST:SWITching:LOFFset:ABSolute?
```

| | |
|-----------|------------|
| Mode: | GSM |
| Key Path: | Meas Setup |

| | |
|---------------|--|
| Unit: | DB |
| Default: | 0.0 |
| State Saved: | Saved in instrument state. |
| Resolution: | 0.1 dB |
| Example: | :SENSE:EORFspectr:LIST:SWITChing:LOFFset:A BSolute 0.0, -2.0, -5.0 |
| Array Length: | Any number from 1 to 15 is acceptable as long as the following arrays have the same number of elements: Custom Switching Offset Frequency Custom Switching Resolution Band Width Custom Switching Relative Limit Level Offsets Custom Switching Absolute Limit Level Offsets Custom Switching Apply Limit Level Offsets |

EDGE ORFS - Custom Switching State

```
[ :SENSE ] :EORFspectr:LIST:SWITChing [ :FREQuency ] <offset  
freq> { , <offset freq> }
```

```
[ :SENSE ] :EORFspectr:LIST:SWITChing [ :FREQuency ] ?
```

```
[ :SENSE ] :EORFspectr:LIST:SWITChing:STATE  
OFF | ON | 0 | 1 { , OFF | ON | 0 | 1 }
```

```
[ :SENSE ] :EORFspectr:LIST:SWITChing:STATE?
```

| | |
|-----------------------|---------------------------------|
| Mode: | GSM |
| Key Path: | Meas Setup |
| Active Function Text: | Offset Freq |
| Default Terminator: | Hz kHz MHz GHz |
| Factory Presets: | |
| Frequency: | 0.0, 4.0e5, 6.0e5, 1.2e6, 1.8e6 |
| State: | 1, 1, 1, 1, 1 |
| State Saved: | Saved in instrument state. |
| SCPI Resolution: | 1.0 Hz |

Example: :SENSe:EORFspectr:LIST:SWITching:FREQuen
 cy 0.0, 1.0e5, 2.0e5

:SENSe:EORFspectr:LIST:SWITching:STATe
ON, ON, ON

Array Length: Any number from 1 to 15 is acceptable as long as
 the following arrays have the same number of
 elements:

Custom Switching Offset Frequency

Custom Switching Resolution Band Width

Custom Switching Relative Limit Level Offsets

Custom Switching Absolute Limit Level Offsets

Custom Switching Apply Limit Level Offsets

EDGE Output RF Spectrum—Define Custom Switching Transient Resolution Bandwidth List

```
[ :SENSe ] :EORFspectr:LIST:SWITching:BANDwidth|BWIDth <res  
bw>{ , <res bw> }
```

```
[ :SENSe ] :EORFspectr:LIST:SWITching:BANDwidth|BWIDth?
```

Define the custom set of resolution bandwidths for the switching transient spectrum part of the EORF measurement. The first bandwidth specified is for the carrier. Each resolution bandwidth in this list corresponds to an offset frequency in the switching transient offset frequency list. The number of items in each of these lists needs to be the same.

Factory Preset: Same as standard list

Range: 1 kHz to 5 MHz

Default Unit: Hz

Remarks: This command is only valid if SENS:EORF:MEAS is set to multiple and the custom list type is selected with SENS:EORF:LIST:SEL CUST.

You must be in EDGE(w/GSM) mode to use this command. Use INSTRument:SElect to set the mode.

EDGE Output RF Spectrum—Define Custom Switching Transient Offset Frequency List

```
[ :SENSe ] :EORFspectr:LIST:SWITching [ :FREQuency ]  
<offset freq>{ , <offset freq> }
```

[[:SENSE]:EORFspectr:LIST:SWITching[:FREQUENCY]?

Define the custom set of offset frequencies at which the switching transient spectrum part of the EORF measurement is made. The first offset specified must be 0 Hz, for the carrier. For each offset frequency specified, the power is measured at both the lower and upper offsets. Up to 14 (+ the 0 Hz carrier frequency) offset frequencies may be defined.

Factory Preset: Same as standard list

Range: 10 kHz to 10 MHz

Default Unit: Hz

Remarks: This command is only valid if SENS:EORF:MEAS is set to multiple and the custom list type is selected with SENS:EORF:LIST:SEL CUST.

You must be in GSM, EDGE mode to use this command. Use INSTRument:SElect to set the mode.

EDGE Output RF Spectrum—Define Custom Switching Transient Relative Limit Level Offsets

[[:SENSE]:EORFspectr:LIST:SWITching:LOFFset[:RCARRIER] <level>{,<level>}

[[:SENSE]:EORFspectr:LIST:SWITching:LOFFset[:RCARRIER]?

Define the custom set of level offsets for the switching transient spectrum part of the EORF measurement. This allows you to modify the standard limits by adding a delta amplitude value to them. The first level offset specified must be 0 dB for the carrier. Each level offset in this list corresponds to an offset frequency in the modulation offset frequency list. The number of items in each of these lists needs to be the same.

Example: See the EORF:LIST:MOD:LOFF example above.

Factory Preset: 0 dB level offsets (limits remain the same as the standards)

Range: 0 to 50 dB

Default Unit: dB

Remarks: This command is only valid if SENS:EORF:MEAS is set to multiple and the custom list type is selected with SENS:EORF:LIST:SEL CUST.

You must be in EDGE(w/GSM) mode to use this command. Use INSTRument:SElect to set the mode.

EDGE Output RF Spectrum—Measure Offsets Measurement Method

```
[ :SENSe ] :EORFspectr:MEASure MULTiple | SINGLE | SWEpt
```

```
[ :SENSe ] :EORFspectr:MEASure?
```

Select the measurement method to be used.

MULTiple - The measurement is done at all offsets in the offset frequency list.

SINGLE - The measurement is done at only one offset as determined by the offset frequency setting. This allows detailed examination of the time-domain waveform at the specified offset frequency.

SWEpt - Sets the trigger source to free run. The previous trigger source selection is restored when measurement mode is returned to **SINGLE** or **MULTiple**.

Factory Preset: **MULTiple**

Remarks: You must be in GSM, EDGE mode to use this command.
Use **INSTRument:SElect** to set the mode.

EDGE Output RF Spectrum—Offset Frequency

```
[ :SENSe ] :EORFspectr:OFRequency <freq>
```

```
[ :SENSe ] :EORFspectr:OFRequency?
```

Set the offset frequency that is used to measure a single offset. This command is only valid if **SENS:EORF:MEAS** is set to **single**.

Factory Preset: 250 kHz

Range: -12.0 MHz to +12.0 MHz

Step Size: Steps through the values in the selected offset frequency list

Default Unit: Hz

Remarks: You must be in GSM, EDGE mode to use this command.
Use **INSTRument:SElect** to set the mode.

EDGE Output RF Spectrum—Trigger Source

```
[ :SENSe ] :EORFspectr:TRIGger:SOURce  
EXTernal [1] | EXTernal2 | FRAME | IMMEDIATE  
| RFBurst
```

```
[ :SENSe ] :EORFspectr:TRIGger:SOURce?
```

Select the trigger source used to control the data acquisitions.

EXTernal 1 - Front panel external trigger input

EXTernal 2 - Rear panel external trigger input

FRAMe - Uses the internal frame timer, which has been synchronized to the selected burst sync

IMMEDIATE - The next data acquisition is immediately taken, capturing the signal asynchronously (also called free run)

RFBurst - Wideband RF burst envelope trigger that has automatic level control for periodic burst signals

Factory Preset: RFBurst

Remarks: You must be in GSM, EDGE mode to use this command. Use INSTRUMENT:SElect to set the mode.

NOTE

Option B7E: RF Comms Hardware has at least three possible part numbers. Press **System, More, Show Hdwr** to show your instrument's RF Comms Hardware and view the part number. If the part number is E4401-60087 (the original version), the RF Burst trigger source is not available with this measurement, and the default is **EXTernal**.

EDGE Output RF Spectrum—Measurement Type

```
[ :SENSe ] :EORFspectr:TYPE
MODulation | MSWitching | SWITching | FFModulation
```

```
[ :SENSe ] :EORFspectr:TYPE?
```

Select the measurement type.

MODulation - Only the modulation spectrum is measured.

MSWitching (Modulation & Switching) - Both modulation and switching transient spectrums are measured.

SWITching - Only the switching transient spectrum is measured.

FFModulation - Full frame modulation improves measurement speed by acquiring a full frame of data prior to performing the FFT calculation. FFT modulation can only be used if all slots in the transmitted frame are active.

Factory Preset: MODulation

Remarks: You must be in the GSM, EDGE mode to use this command. Use INSTRUMENT:SElect to set the mode.

EDGE Output RF Spectrum—Select Modulation Method

```
[ :SENSe ] :EORFspectr:TYPE:MODulation [ :METHod ] DISCcrete | SWEEp
```

`[:SENSE] :EORFspectr:TYPE:MODulation [:METHod] ?`

Selects discrete or sweep modulation method.

Discrete - Measures RF output spectrum at preset frequency offsets. Results are returned in tabular form.

Sweep - Measures output RF spectrum from -1.8 MHz to +1.8 MHz offset in approximately 10 kHz steps. Results are returned as a trace.

Remarks: You must be in GSM, EDGE, GSM mode to use this command. Use INSTRument:SELEct to set the mode.

EDGE Power vs. Time (Burst Power) Measurement

Commands for querying the power versus time measurement results and for setting to the default values are found in the “MEASure Group of Commands” on page 347. The equivalent front panel keys for the parameters described in the following commands, are found under the **Meas Setup** key, after the **EDGE PwT** measurement has been selected from the **MEASURE** key menu.

History: For E4406A: added in version A.04.00.

EDGE Power vs. Time—Number of Bursts Averaged

```
[ :SENSE ] :EPVTime:AVERAge:COUNT <integer>
```

```
[ :SENSE ] :EPVTime:AVERAge:COUNT?
```

Set the number of bursts that are averaged. After the specified number of bursts (average counts), the averaging mode (termination control) setting determines the averaging action.

Factory Preset: 10

Range: 1 to 10,000

Remarks: You must be in the GSM, EDGE mode to use this command. Use INSTRument:SElect to set the mode.

EDGE Power vs. Time—Averaging State

```
[ :SENSE ] :EPVTime:AVERAge [:STATe] OFF | ON | 0 | 1
```

```
[ :SENSE ] :EPVTime:AVERAge [:STATe] ?
```

Turn averaging on or off.

Factory Preset: OFF

Remarks: You must be in the GSM, EDGE mode to use this command. Use INSTRument:SElect to set the mode.

EDGE Power vs. Time—Averaging Termination Control

```
[ :SENSE ] :EPVTime:AVERAge:TCONtrol EXPOnential | REPEAT
```

```
[ :SENSE ] :EPVTime:AVERAge:TCONtrol ?
```

Select the type of termination control used for the averaging function. This specifies the averaging action after the specified number of bursts (average count) is reached.

EXPOnential - After the average count has been reached, each

successive data acquisition is exponentially weighted and combined with the existing average.

REPeat - After reaching the average count, the averaging is reset and a new average is started.

Factory Preset: EXPOnential

Remarks: You must be in the GSM, EDGE mode to use this command. Use INSTRument:SElect to set the mode.

EDGE Power vs. Time—Averaging Type

```
[ :SENSe ] :EPVTime:AVERAge:TYPE  
LOG | MAXimum | MINimum | MXMinimum | RMS
```

```
[ :SENSe ] :EPVTime:AVERAge:TYPE?
```

Select the type of averaging to be performed.

LOG - The log of the power is averaged. (This is also known as video averaging.)

MAXimum - The maximum values are retained.

MINimum - The minimum values are retained.

MXMinimum - Both the maximum and the minimum values are retained.

RMS - The power is averaged, providing the rms of the voltage.

Factory Preset: RMS

Remarks: You must be in the GSM, EDGE mode to use this command. Use INSTRument:SElect to set the mode.

EDGE Power vs. Time—Resolution BW

```
[ :SENSe ] :EPVTime:BANDwidth|BWIDth[:RESolution] <freq>
```

```
[ :SENSe ] :EPVTime:BANDwidth|BWIDth[:RESolution]?
```

Set the resolution BW. This is an advanced control that normally does not need to be changed. Setting this to a value other than the factory default, may cause invalid measurement results.

Factory Preset: 500 kHz

Range: 1 kHz to 5 MHz

Default Unit: Hz

Remarks: You must be in the GSM, EDGE mode to use this command. Use INSTRument:SElect to set the mode.

EDGE Power vs. Time—RBW Filter Type

```
[ :SENSE ] :EPVTime :BANDwidth | BWIDth [ :RESolution ] :TYPE  
FLATtop | GAUSSian
```

```
[ :SENSE ] :EPVTime :BANDwidth | BWIDth [ :RESolution ] :TYPE?
```

Select the type of resolution BW filter. This is an advanced control that normally does not need to be changed. Setting this to a value other than the factory default, may cause invalid measurement results.

FLATtop - A filter with a flat amplitude response, which provides the best amplitude accuracy.

GAUSSian - A filter with Gaussian characteristics, which provides the best pulse response.

Factory Preset: GAUSSian

Remarks: You must be in the GSM, EDGE mode to use this command. Use INSTRument:SElect to set the mode.

EDGE P_vT Timeslot Length

```
[ :SENSe ] :EPVTime :BSYNc :SLENgth EVEN | INTeger
```

```
[ :SENSe ] :EPVTime :BSYNc :SLENgth?
```

| | |
|-----------------------------|--|
| Mode: | GSM |
| Key Path: | Meas Setup, More, Advanced |
| Factory Preset: | INTeger |
| State Saved: | Saved in instrument state. |
| Range: | All 156.25 symb 157/156 symb |
| Dependencies and Couplings: | This parameter is available only if the Burst Sync type is None. |
| Example: | :SENSe:PVTTime:BSYNc:SLENgth INTeger |

EDGE P_vT Burst Synchronization Source

```
[ :SENSe ] :EPVTime :BSYNc :SOURce TSEquence | RFBurst | NONE
```

```
[ :SENSe ] :EPVTime :BSYNc :SOURce?
```

This parameter specifies how the measurement algorithm synchronizes the reference time with the given signal.

| | |
|---------------------------------------|---|
| KEY Training Seq SCPI TSEquence | The measurement algorithm first searches bursts and then searches training sequence (midamble) of each burst to determine the reference time for the limit mask. The reference time is adjusted slot-by-slot. |
| KEY RF Amptd SCPI RFBurst | The measurement algorithm calculates the burst width and determines the reference time for the limit mask so that the t0 comes to the center of each burst. The reference time is adjusted slot-by-slot. |
| KEY None (Trigger Delay) SCPI NONE | The measurement algorithm does not search bursts at all. The timing to capture data is determined by user-defined Trigger Delay. |

| | |
|-----------------|--|
| Mode: | GSM |
| Key Path: | Meas Setup |
| Factory Preset: | TSEquence |
| State Saved: | Saved in instrument state. |
| Range: | Training Seq RF Amptd None (Trigger Delay) |
| Notes: | None choice is always available. However, the choice is meaningful only if the Trig Source is Ext Front or Ext Rear. |
| Example: | :SENSe:EPVTime:BSYNc:SOURce TSEquence |

EDGE Power vs. Time—Limit Line Mask Display

[:SENSe] :EPVTime:LIMit:MASK OFF | ON | 0 | 1

[:SENSe] :EPVTime:LIMit:MASK?

Show or hide the limit mask. Does not affect limit pass/fail calculation.

Same as :DISPlay:EPVTime:LIMit:MASK. The sense version was added to be compatible/consistent with ESA.

Factory Preset: ON

Range: ON | OFF

Remarks: You must be in GSM, EDGE mode to use this command. Use INSTRument:SElect to set the mode.

EDGE Power vs. Time—Lower Mask Absolute Amplitude Levels

```
[ :SENSE ] : EPVTime : MASK : LIST : LOWer : ABSolute  
<power>, <power>, <power>, <power>, <power>, . . .
```

```
[ :SENSE ] : EPVTime : MASK : LIST : LOWer : ABSolute?
```

Enter a power level for any of your mask line segments that require an absolute minimum power limit in addition to its relative limit. Each time a measurement is made the Ref Level is determined. (This is the power level of the useful part of the burst, or midway between the upper/lower masks). Remember, as the power of the Ref Level changes, all of the relative mask power levels change by the same amount.

Each relative limit is then compared to the Ref Level and an equivalent absolute power level is calculated. This power level is compared to the specified absolute limit for each line segment. If this calculated relative limit is lower than the absolute limit you've specified, then the value of the absolute limit is used for this segment. Therefore, if the absolute limit is set to a very low value (–200 dBm), the calculated value of the reference limit will never be lower, and the specified relative limit is always used for that segment. See [Figure 1 on page 426](#).

Every time point you defined with PVT:MASK:LOW:TIME must have a power value defined in the same order. You can put a comma in the SCPI command as a place holder for any points where an absolute power is not specified, and that segment then uses the default value.

Factory Preset: Selected EDGE standard

Range: –200 dBm to +100 dBm

Default Unit: dBm

Remarks: You must be in GSM, EDGE mode to use this command.
Use INSTRUMENT:SElect to set the mode.

EDGE Power vs. Time—Lower Mask Points

```
[ :SENSE ] : EPVTime : MASK : LIST : LOWer : POINTs?
```

Query the number of elements in the lower mask. This value is determined by the number of time points entered using

```
[ :SENSE ] : EPVTime : MASK : LIST : LOWer : TIME.
```

Range: Integer, 1 to 25

Remarks: You must be in GSM, EDGE mode to use this command.
Use INSTRUMENT:SElect to set the mode.

EDGE Power vs. Time—Lower Mask Relative Amplitude Levels

```
[ :SENSe ] :EPVTime:MASK:LIST:LOWer:RELative  
<rel_power>,<rel_power>,<rel_power>,<rel_power>,<rel_power>  
,...  
[ :SENSe ] :EPVTime:MASK:LIST:LOWer:RELative?
```

Enter the relative power level for each horizontal line segment in the lower limit mask. There should be a power level for each time point entered using [:SENSe] :EPVTime:MASK:LIST:LOWer:TIME, and they must be entered in the same order. These power levels are all relative to the defined Reference Power Level (the average power in the useful part of the data).

Any portion of the signal that has no limit line segment defined for it defaults to a very low limit (–100 dB relative to the reference power). This keeps the measurement from indicating a failure for that portion of the data.

Factory Preset: Selected EDGE standard

Range: +200 dB to –100 dB, relative to the reference power

Default Unit: dB

Remarks: You must be in GSM, EDGE mode to use this command.
Use INSTRument:SElect to set the mode.

EDGE Power vs. Time—Lower Mask Time Points

```
[ :SENSe ] :EPVTime:MASK:LIST:LOWer:TIME  
<seconds>,<seconds>,<seconds>,<seconds>,<seconds>,...  
[ :SENSe ] :EPVTime:MASK:LIST:LOWer:TIME?
```

Enter the time points that define the horizontal line segments of the lower limit. A reference point designated “ t_0 ” is at the center of the useful data (usually the center of the burst). Each line segment to the right of the t_0 reference point is designated as a positive time value and each segment to the left of t_0 is a negative time value.

First enter positive values in sequence starting from t_0 , then negative values in sequence starting from t_0 . See [Figure 1 on page 426](#) and the [:SENSe] :EPVT:MASK:LIST:UPPER:TIME example below it. (This is an upper mask example, but they work the same.)

We recommend that you select a large time value for your first and last mask points (e.g. –1 and +1 second). This guarantees that you’ve defined a limit for all the measured data. (See Mask Segments 4 and 9 in the [Table on page 427](#) for an example.)

Factory Preset: Selected EDGE standard

Range: -1s to +1s, referenced to t_0 at the center of the useful data (burst center)
1 to 25 time points in a mask

Default Unit: seconds

Remarks: You must be in the GSM, EDGE mode to use this command. Use INSTRUMENT:SElect to set the mode.

EDGE Power vs. Time—Upper Mask Absolute Amplitude Levels

```
[ :SENSE ] :EPVTime:MASK:LIST:UPPER:ABSolute
<power>, <power>, <power>, <power>, <power>, . . .
```

```
[ :SENSE ] :EPVTime:MASK:LIST:UPPER:ABSolute?
```

Enter a power level for any of your mask line segments that require an absolute minimum power limit in addition to its relative limit. Each time a measurement is made the Ref Level is determined. (This is the power level of the useful part of the burst, or midway between the upper/lower masks). Remember, as the power of the Ref Level changes, all of the relative mask power levels change by the same amount.

Each relative limit is then compared to the Ref Level and an equivalent absolute power level is calculated. This power level is compared to the specified absolute limit for each line segment. If this calculated relative limit is lower than the absolute limit you've specified, then the value of the absolute limit is used for this segment. Therefore, if the absolute limit is set to a very low value (-200 dBm), the calculated value of the reference limit will never be lower, and the specified relative limit is always used for that segment. See [Figure 1 on page 426](#).

Every time point you defined with PVT:MASK:LOW:TIME must have a power value defined in the same order. You can put a comma in the SCPI command as a place holder for any points where an absolute power is not specified, and that segment then uses the default value.

Example: **EPVT:MASK:LIST:UPP:ABS**
-200, -200, -58, -200, -200, -200, -200, -58, -200

Factory Preset: Selected EDGE standard

Range: -200 dBm to +100 dBm

Default Unit: dBm

Remarks: You must be in GSM, EDGE mode to use this command. Use INSTRUMENT:SElect to set the mode.

EDGE Power vs. Time—Upper Mask Points

```
[ :SENSe ] :EPVTime:MASK:LIST:UPPer:POINTs?
```

Query the number of elements in the upper mask. This value is determined by the number of time points entered using

```
[ :SENSe ] :EPVTime:MASK:LIST:UPPer:TIME.
```

Range: Integer, 1 to 25

Remarks: You must be in GSM, EDGE mode to use this command.
Use INSTRument:SElect to set the mode.

EDGE Power vs. Time—Upper Mask Relative Amplitude Levels

```
[ :SENSe ] :EPVTime:MASK:LIST:UPPer:RELative  
<rel_power>,<rel_power>,<rel_power>,<rel_power>,<rel_power>  
.....
```

```
[ :SENSe ] :EPVTime:MASK:LIST:UPPer:RELative?
```

Enter the relative power level for each horizontal line segment in the upper limit mask. There should be a power level for each time point entered using [:SENSe] :EPVTime:MASK:LIST:UPPer:TIME, and they must be entered in the same order. These power levels are all relative to the defined Reference Power Level (the average power in the useful part of the data). See [Figure 1 on page 426](#).

Figure 1 Custom Upper Limit Mask Example

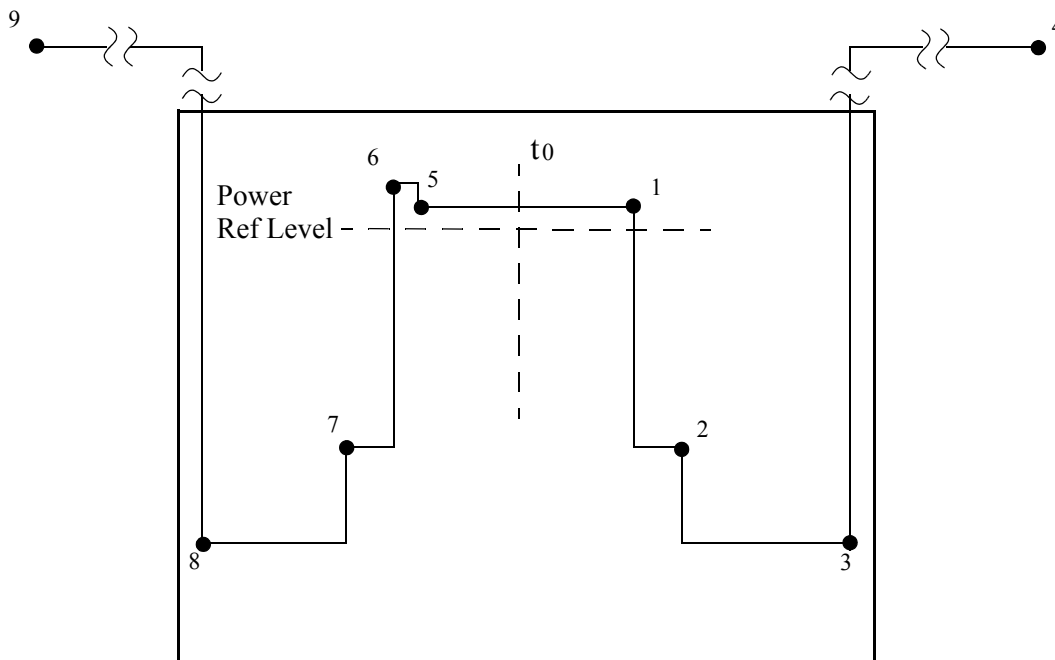

| Entered Value for each Time Segment | Absolute Time Value | Relative Power (example (with Ref Level = -12 dBm)) | | Entered Absolute Power (dBm) | Segment Number |
|-------------------------------------|---------------------|---|---------------------------|------------------------------|----------------|
| | | Entered Relative Power | Equivalent Absolute Power | | |
| 280.0e-6 | 280 μ s | +4 dBc | -8 dBm | -200 dBm | 1 |
| 15.0e-6 | 295 μ s | -32 dBc | -44 dBm | -200 dBm | 2 |
| 450.0e-6 | 745 μ s | -48 dBc | -60 dBm ^a | -58 dBm ^a | 3 |
| 1 | >1 sec | +100 dBc | +88 dBm | -200 dBm | 4 |
| -270.0e-6 | -270 μ s | +4 dBc | -8 dBm | -200 dBm | 5 |
| -10.0e-6 | -280 μ s | +7 dBc | -5 dBm | -200 dBm | 6 |
| -20.0e-6 | -300 μ s | -25 dBc | -37 dBm | -200 dBm | 7 |
| -450e-6 | -750 μ s | -43 dBc | -55 dBm | -58 dBm | 8 |
| -1 | <-1 sec | +100 dBc | +88 dBm | -200 dBm | 9 |

a. Notice that this segment, with this value of Ref Level, has a calculated relative level of -60 dBm. This is lower than the specified absolute level of -58 dBm, so the -58 dBm value is used as the test limit for the segment.

Example: EPVT:MASK:LIST:UPP:REL 4, -32, -48, 100, 4, 7, -25, -43, 100

Factory Preset: Selected EDGE standard

Range: 200 dB to -100 dB, relative to the reference power

Default Unit: dB

Remarks: You must be in GSM, EDGE mode to use this command.
Use INSTRUMENT:SELEct to set the mode.

EDGE Power vs. Time—Upper Mask Time Points

```
[ :SENSE ] : EPVTime : MASK : LIST : UPPer : TIME
<seconds>, <seconds>, <seconds>, <seconds>, <seconds>, ...
```

```
[ :SENSE ] : EPVTime : MASK : LIST : UPPer : TIME?
```

Enter the time points that define the horizontal line segments of the upper limit. A reference point designated “ t_0 ” is at the center of the useful data (usually the center of the burst). Each line segment to the right of the t_0 reference point is designated as a positive value and each segment to the left of t_0 is a negative value.

First enter positive values in sequence starting from t_0 , then the negative values in sequence starting from t_0 . See [Figure 1 on page 426](#) and the EPVT:MASK:LIST:UPPER:TIME example below it.

We recommend that you select a large time value for your first and last mask points (e.g. -1 and +1 second). This guarantees that you've defined a limit for all the measured data. (See Mask Segments 4 and 9 in the [Table on page 427](#) for an example.

Example: EPVT:MASK:LIST:UPP:TIME
280e-6,15e-6,1,-270e-6,-10e-6,-20e-6,-1

Factory Preset: Selected EDGE standard

Range: -1s to +1s, referenced to t_0 at the center of the useful data (burst center)
1 to 25 time points in a mask

Default Unit: seconds

Remarks: You must be in the GSM, EDGE mode to use this command. Use INSTRument:SElect to set the mode.

EDGE Power vs. Time—Custom Limit Masks

```
[ :SENSe ] :EPVTime:MASK:SElect STANDARD|CUSTom
```

```
[ :SENSe ] :EPVTime:MASK:SElect?
```

Select standard masks or user-defined custom masks against which to compare your measured data. See [“EDGE PvT Custom Limit Mask Example of Two Consecutive Bursts” on page 428](#)

Factory Preset: STANdard

Remarks: You must be in GSM, EDGE mode to use this command. Use INSTRument:SElect to set the mode.

EDGE PvT Custom Limit Mask Example of Two Consecutive Bursts

Figure 4-4 **EDGE PvT Custom Limit Mask Example of Two Consecutive**

Bursts

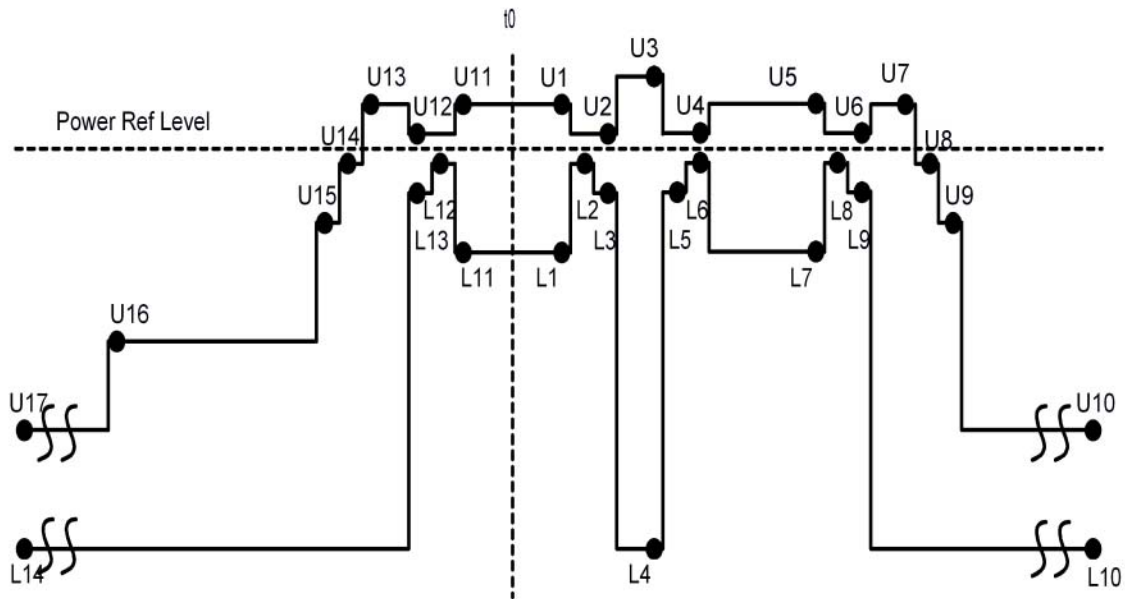

Upper Mask

| Segment Number | Timing | Relative Limit Level | Absolute Limit Level |
|----------------|----------------|----------------------|----------------------|
| U1 | 267.384615e-6 | 4.0 | -200.0 |
| U2 | 4.0e-6 | 2.4 | -200.0 |
| U3 | 33.23e-6 | 7.0 | -200.0 |
| U4 | 4.0e-6 | 2.4 | -200.0 |
| U5 | 534.76923e-6 | 4.0 | -200.0 |
| U6 | 4.0e-6 | 2.4 | -200.0 |
| U7 | 10.0e-6 | 4.0 | -200.0 |
| U8 | 8.0e-6 | -6.0 | -200.0 |
| U9 | 10.0e-6 | -30.0 | -17.0 |
| U10 | 1.0 | -59.0 | -54.0 |
| U11 | -267.384615e-6 | 4.0 | -200.0 |
| U12 | -4.0e-6 | 2.4 | -200.0 |
| U13 | -10.0e-6 | 4.0 | -200.0 |
| U14 | -8.0e-6 | -6.0 | -200.0 |

Programming Commands
SENSe Subsystem

| | | | |
|-----|-----------|-------|-------|
| U15 | -10.0e-6 | -30.0 | -17.0 |
| U16 | -576.0e-6 | -59.0 | -36.0 |
| U17 | -1.0 | -59.0 | -54.0 |

Lower Mask

| Segment Number | Timing | Relative Limit Level | Absolute Limit Level |
|----------------|----------------|----------------------|----------------------|
| L1 | 267.384615e-6 | -20.0 | -200.0 |
| L2 | 2.0e-6 | 0.0 | -200.0 |
| L3 | 2.0e-6 | -2.0 | -200.0 |
| L4 | 33.23e-6 | -200.0 | -200.0 |
| L5 | 2.0e-6 | -2.0 | -200.0 |
| L6 | 2.0e-6 | 0.0 | -200.0 |
| L7 | 534.76923e-6 | -20.0 | -200.0 |
| L8 | 2.0e-6 | 0.0 | -200.0 |
| L9 | 2.0e-6 | -2.0 | -200.0 |
| L10 | 1.0 | -200.0 | -200.0 |
| L11 | -267.384615e-6 | -20.0 | -200.0 |
| L12 | -2.0e-6 | 0.0 | -200.0 |
| L13 | -2.0e-6 | -2.0 | -200.0 |
| L14 | -1.0 | -200.0 | -200.0 |

Sample SCPI Sequence to Define The Above Mask

```

:SENSe:EPVTime:MASK:SElect CUST
:SENSe:EPVTime:SWEep:TIME 3
:SENSe:EPVTime:MASK:LIST:UPPer:TIME 267.384615e-6, 4.0e-6,
33.23e-6, 4.0e-6, 534.76923e-6, 4.0e-6, 10.0e-6, 8.0e-6, 10.0e-6, 1.0,
-267.384615e-6, -4.0e-6, -10.0e-6, -8.0e-6, -10.0e-6, -576.0e-6, -1.0
:SENSe:EPVTime:MASK:LIST:UPPer:RELative 4.0, 2.4, 7.0, 2.4, 4.0,
2.4, 4.0, -6.0, -30.0, -59.0,4.0, 2.4, 4.0, -6.0, -30.0, -59.0, -59.0
:SENSe:EPVTime:MASK:LIST:UPPer:ABSolute -200.0, -200.0, -200.0,
-200.0, -200.0, -200.0, -200.0, -17.0, -54.0, -200.0, -200.0, -200.0,
-200.0, -17.0, -36.0, -54.0
:SENSe:EPVT:MASK:LIST:LOWer:TIME 267.384615e-6, 2.0e-6, 2.0e-6,
33.23e-6, 2.0e-6, 2.0e-6, 534.76923e-6, 2.0e-6, 2.0e-6, 1.0,
-267.384615e-6, -2.0e-6, -2.0e-6, -1.0
:SENSe:EPVTime:MASK:LIST:LOWer:RELative -20.0, 0.0, -2.0, -200.0,
-2.0, 0.0, -20.0, 0.0, -2.0, -200.0, -20.0, 0.0, -2.0, -200.0
:SENSe:EPVTime:MASK:LIST:LOWer:ABSolute -200.0, -200.0, -200.0,
-200.0, -200.0, -200.0, -200.0, -200.0, -200.0, -200.0, -200.0,
-200.0, -200.0

```

EDGE Power vs Time - Select Power Control Level

Allows you to indicate the output power of the transmitter; in MS testing transmitter output power level affects the mask. The appropriate power level for measuring the device under test corresponds with the transmitter power control level setting.

```
[ :SENSe ] :EPVTime:PCLevel <integer>
```

```
[ :SENSe ] :EPVTime:PCLevel?
```

Range: 0 to 40

Remarks: You must be in GSM, EDGE mode to use this command.
Use INSTRument:SElect to set the mode

Front Panel Access: **Meas Setup, More, Pwr Cntrl Lvl.**

EDGE Power vs. Time—Sweep Time

```
[ :SENSe ] :EPVTime:SWEep:TIME <integer>
```

```
[ :SENSe ] :EPVTime:SWEep:TIME?
```

Set the number of slots which are used in each data acquisition. Each

slot is approximately equal to 570 μ s. The measurement is made for a small additional amount of time (about 130 μ s) in order to view the burst edges.

Factory Preset: 1

Range: 1 to 8 (for resolution BW = 500 kHz)

Remarks: You must be in the GSM, EDGE mode to use this command. Use INSTRument:SElect to set the mode.

EDGE Power vs. Time—Trigger Source

```
[[:SENSe]:EPVTime:TRIGger:SOURce EXTernal [1] | EXTernal2  
| FRAMe | IF | IMMEDIATE | RFBurst
```

```
[[:SENSe]:EPVTime:TRIGger:SOURce?
```

Select the trigger source used to control the data acquisitions.

EXTernal 1 - front panel external trigger input

EXTernal 2 - rear panel external trigger input

FRAMe - uses the internal frame timer, which has been synchronized to the selected burst sync.

IF - internal IF envelope (video) trigger

IMMEDIATE - the next data acquisition is immediately taken, capturing the signal asynchronously (also called Free Run).

RFBurst - wideband RF burst envelope trigger that has automatic level control for periodic burst signals.

Factory Preset: RFBurst

Remarks: You must be in the GSM, EDGE mode to use this command. Use INSTRument:SElect to set the mode.

NOTE

Option B7E: RF Comms Hardware has at least three possible part numbers. Press **System, More, Show Hdwr** to show your instrument's RF Comms Hardware and view the part number. If the part number is E4401-60087 (the original version), the RF Burst trigger source is not available with this measurement, and the default is **EXTernal**.

EDGE Transmit Band Spurs Measurement

Commands for querying the EDGE transmit band spurs measurement results and for setting to the default values are found in the “[MEASure Group of Commands](#)” on page 347. The equivalent front panel keys for the parameters described in the following commands, are found under the **Meas Setup** key, after the **EDGE TxBand Spur** measurement has been selected from the **MEASURE** key menu.

History: E4406A:
The EDGE version of the GSM transmit band spurs measurement was added in version A.05.00

Transmit Band Spurs—Average Count

`[:SENSE] :ETSPur:AVERAge:COUNT <integer>`

`[:SENSE] :ETSPur:AVERAge:COUNT?`

Set the number of data acquisitions that are averaged. After the specified number of average counts, the averaging mode (termination control) setting determines the averaging action.

Factory Preset: 30

Range: 1 to 10,000

Remarks: You must be in GSM, EDGE mode to use this command.
Use `INSTRument:SElect` to set the mode.

Transmit Band Spurs—Averaging State

`[:SENSE] :ETSPur:AVERAge [:STATe] OFF | ON | 0 | 1`

`[:SENSE] :ETSPur:AVERAge [:STATe] ?`

Turn averaging on or off.

Factory Preset: ON

Remarks: You must be in GSM, EDGE mode to use this command.
Use `INSTRument:SElect` to set the mode.

Transmit Band Spurs—Averaging Termination Control

`[:SENSE] :ETSPur:AVERAge:TCONTrOl EXPOnential | REPeat`

`[:SENSE] :ETSPur:AVERAge:TCONTrOl?`

Select the type of termination control used for the averaging function. This determines the averaging action after the specified number of data acquisitions (average count) is reached.

EXPOnential - After the average count has been reached, each

successive data acquisition is exponentially weighted and combined with the existing average.

REPeat - After reaching the average count, the averaging is reset and a new average is started.

Factory Preset: REPeat

Remarks: You must be in GSM, EDGE mode to use this command.
Use INSTRument:SElect to set the mode.

Transmit Band Spurs—Averaging Type

```
[ :SENSe ] :ETSPur :AVERage :TYPE LOG | MAXimum | RMS
```

```
[ :SENSe ] :ETSPur :AVERage :TYPE ?
```

Select the type of averaging.

LOG - The log of the power is averaged. (This is also known as video averaging.)

MAXimum - The maximum values are retained.

RMS - The power is averaged, providing the rms of the voltage.

Factory Preset: MAXimum

Remarks: You must be in GSM, EDGE mode to use this command.
Use INSTRument:SElect to set the mode.

Transmit Band Spurs—Type

```
[ :SENSe ] :ETSPur :TYPE EXAMine | FULL
```

```
[ :SENSe ] :ETSPur :TYPE ?
```

Select the measurement type.

EXAMine - Measures spurs in all the valid segments and then displays the segment that has the worst spur

FULL - Continuously measures the spurs in all the valid segments

Factory Preset: FULL

Remarks: You must be in GSM, EDGE mode to use this command.
Use INSTRument:SElect to set the mode.

RF Input Signal Alignments

Select the Input Signal

PSA:

```
[ :SENSe] :FEED RF | AREFERENCE | IFALign | WBALign
```

E4406A:

```
[ :SENSe] :FEED RF | IQ | IONLy | QONLy | AREFERENCE | IFALign
```

```
[ :SENSe] :FEED?
```

Selects the input signal. The default input signal is taken from the front panel RF input port. For calibration and testing purposes the input signal can be taken from an internal 321.4 MHz IF alignment signal or an internal 50 MHz amplitude reference source.

For E4406A if the baseband IQ option (Option B7C) is installed, I and Q input ports are added to the front panel. The I and Q ports accept the in-phase and quadrature components of the IQ signal, respectively. The input signal can be taken from either or both ports.

RF - Selects the signal from the front panel RF INPUT port.

IQ - Selects the combined signals from the front panel optional I and Q input ports. (E4406A with Option B7C in Basic, W-CDMA, cdma2000, EDGE(w/GSM) modes)

IONLy - Selects the signal from the front panel optional I input port. (E4406A with Option B7C in Basic mode)

QONLy - Selects the signal from the front panel optional Q input port. (E4406A with Option B7C in Basic mode)

AREFERENCE - Selects the internal 50 MHz amplitude reference signal.

IFALign - Selects the internal, 321.4 MHz, IF alignment signal.

WBALign - Selects the internal IF alignment signal for the wide bandwidth hardware path. (PSA with Option 122 in Basic mode)

Factory Preset: RF

Front Panel

Access: **Input, Input Port**

Remarks: To use this command for E4406A, the appropriate mode should be selected with INSTRUMENT:SElect.

For PSA you must be in the Basic, cdmaOne, cdma2000, 1xEV-DO, W-CDMA, GSM, EDGE, NADC, or PDC mode to use this command. Use INSTRUMENT:SElect to set the mode.

Programming Commands
SENSe Subsystem

History: E4406A: modified in version A.05.00.
 PSA modified in version A.06.00.

Frequency Commands

Center Frequency

`[:SENSe] :FREQuency:CENTer <freq>`

`[:SENSe] :FREQuency:CENTer?`

Set the center frequency.

Factory Preset: PSA

E4443A: 3.35 GHz for SA

E4445A: 6.5 GHz for SA

E4440A: 13.25 GHz for SA

1.0 GHz for Basic, cdmaOne, cdma2000, W-CDMA, NADC, PDC modes

935.2 MHz for GSM, EDGE modes

Factory Preset: 1.0 GHz

942.6 MHz for GSM, EDGE

806.0 MHz for iDEN

Range: PSA

E4443A: 3 Hz to 6.7 GHz for SA

E4445A: 3 Hz to 13.2 GHz for SA

E4440A: 3 Hz to 26.5 GHz for SA

3 Hz to 1.5 GHz for Basic, cdmaOne, cdma2000, W-CDMA, GSM, EDGE, NADC, PDC modes (Measurement specifications are only applicable up to 3 GHz.)

Range: 1.0 kHz to 4.3214 GHz

Default Unit: Hz

Front Panel

Access: **FREQUENCY/Channel, Center Freq**

Center Frequency Step Size

`[:SENSe] :FREQuency:CENTer:STEP [:INCRement] <freq>`

`[:SENSe] :FREQuency:CENTer:STEP [:INCRement] ?`

Specifies the center frequency step size.

Factory Preset: 5.0 MHz (E4406A)

1.25 MHz for cdma2000 (E4406A)
Range: 1.0 kHz to 1.0 GHz, in 10 kHz steps (E4406A)
Default Unit: Hz
History: E4406A:
Version A.03.00 or later
Front Panel
Access: **FREQUENCY/Channel, CF Step**

GMSK Output RF Spectrum Measurement

Commands for querying the output RF spectrum measurement results and for setting to the default values are found in the “[MEASure Group of Commands](#)” on page 347. The equivalent front panel keys for the parameters described in the following commands, are found under the **Meas Setup** key, after the **GMSK Output RF Spectrum** measurement has been selected from the **MEASURE** key menu.

GMSK ORFS - Custom Modulation Apply Limit Level Offsets

```
[ :SENSe ] :ORFSpectrum:LIST:MODulation:APPLY  
RELative | BOTH | ABSolute { , RELative | BOTH | ABSolute }
```

```
[ :SENSe ] :ORFSpectrum:LIST:MODulation:APPLY?
```

Mode: GSM
Key Path: **Meas Setup**
Default: BOTH, BOTH, BOTH, BOTH, BOTH, BOTH,
BOTH, BOTH, BOTH, BOTH, BOTH, BOTH,
BOTH, BOTH, BOTH
State Saved: Saved in instrument state.
Range: Rel | Both | Abs
Example: :SENSe:ORFSpectrum:LIST:MODulation:APPLY
RELative, RELative, RELative

Array Length: Any number from 1 to 15 is acceptable as long as the following arrays have the same number of elements:

- Custom Switching Offset Frequency
- Custom Switching Resolution Band Width
- Custom Switching Relative Limit Level Offsets
- Custom Switching Absolute Limit Level Offsets
- Custom Switching Apply Limit Level Offsets

GMSK Output RF Spectrum—Number of Bursts Averaged

`[:SENSE] :ORFSpectrum:AVERAge:COUNT <integer>`

`[:SENSE] :ORFSpectrum:AVERAge:COUNT?`

Set the number of bursts that are averaged. For the output RF spectrum due to switching transients, it is more accurate to consider this the number of frames that are measured. After the specified number of bursts (average counts), the averaging mode (termination control) setting determines the averaging action.

Factory Preset: 15

Range: 1 to 10,000

Remarks: You must be in the GSM, EDGE mode to use this command. Use `INSTRument:SElect` to set the mode.

GMSK Output RF Spectrum—Fast Averaging

`[:SENSE] :ORFSpectrum:AVERAge:FAST [:STATe] OFF | ON | 0 | 1`

`[:SENSE] :ORFSpectrum:AVERAge:FAST [:STATe] ?`

Make the measurement faster by using an averaging technique different from that defined by the standard. A valid average can be obtained by measuring the power in half the normal number of bursts by using 50% - 90% of the burst, 10% - 50% of the burst and excluding the midamble.

This faster averaging is only done when averaging is on and only the modulation results are being measured. If both modulation and switching transients results are being measured, then the measurement uses the default averaging.

Factory Preset: ON

Remarks: You must be in the GSM, EDGE mode to use this command. Use `INSTRument:SElect` to set the mode.

GMSK Output RF Spectrum—Averaging Type for Modulation Spectrum

```
[ :SENSe ] :ORFSpectrum:AVERAge:MODulation:TYPE LOG | RMS
```

```
[ :SENSe ] :ORFSpectrum:AVERAge:MODulation:TYPE?
```

Select the type of averaging for measuring the modulation spectrum. This is an advanced control that normally does not need to be changed. Setting this to a value other than the factory default, may cause invalid measurement results.

LOG - The log of the power is averaged. (This is also known as video averaging.)

RMS - The power is averaged, providing the rms of the voltage.

Factory Preset: LOG

Remarks: You must be in the GSM, EDGE mode to use this command. Use INSTRument:SElect to set the mode.

GMSK Output RF Spectrum—Averaging Control

```
[ :SENSe ] :ORFSpectrum:AVERAge [ :STATe ] OFF | ON | 0 | 1
```

```
[ :SENSe ] :ORFSpectrum:AVERAge [ :STATe ] ?
```

Turn averaging on or off.

Factory Preset: ON

Remarks: You must be in the GSM, EDGE mode to use this command. Use INSTRument:SElect to set the mode.

GMSK Output RF Spectrum—Averaging Type for Switching Transient Spectrum Query

```
[ :SENSe ] :ORFSpectrum:AVERAge:SWITching:TYPE?
```

Queries the type of averaging for measuring the switching transient spectrum.

Factory Preset: MAXP (maximum peak power)

Remarks: You must be in the GSM, EDGE mode to use this command. Use INSTRument:SElect to set the mode.

History: E4406A:
Query only format adopted for version A.05.00.

GMSK Output RF Spectrum—Resolution BW for the Modulation Spectrum at the Carrier

```
[ :SENSE ] :ORFSpectrum: BANDwidth | BWIDth [ :RESolution ]
:MODulation: CARRIER <freq>
```

```
[ :SENSE ] :ORFSpectrum: BANDwidth | BWIDth [ :RESolution ]
:MODulation: CARRIER?
```

Selects the resolution bandwidth for measuring the carrier when measuring spectrum due to modulation and wideband noise.

This parameter is only used with the Standard or Short lists, and not with the Custom list.

Factory Preset: 30 kHz

Range: 1 kHz to 5 MHz

Default Unit: Hz

Remarks: You must be in the GSM, EDGE mode to use this command. Use INSTRUMENT:SElect to set the mode.

GMSK Output RF Spectrum—Resolution BW For Modulation At Close Offsets

```
[ :SENSE ] :ORFSpectrum: BANDwidth | BWIDth [ :RESolution ]
:MODulation: OFFSet: CLOSe <freq>
```

```
[ :SENSE ] :ORFSpectrum: BANDwidth | BWIDth [ :RESolution ]
:MODulation: OFFSet: CLOSe?
```

Set the resolution bandwidth used for the spectrum due to modulation part of the ORFS measurement for offset frequencies less than 1800 kHz.

This parameter is only used with the Standard or Short lists, and not with the Custom list.

Factory Preset: 30 kHz

Range: 1 kHz to 5 MHz

Default Unit: Hz

Remarks: You must be in the GSM, EDGE mode to use this command. Use INSTRUMENT:SElect to set the mode.

GMSK Output RF Spectrum—Resolution BW for Modulation at Far Offsets

```
[ :SENSE ] :ORFSpectrum: BANDwidth | BWIDth [ :RESolution ]
:MODulation: OFFSet: FAR <freq>
```

```
[ :SENSe ] :ORFSpectrum: BANDwidth | BWIDth [ :RESolution ]  
:MODulation: OFFSet: FAR?
```

Set the resolution bandwidth used for the spectrum due to modulation part of the ORFS measurement for offset frequencies greater than or equal to 1800 kHz.

For E4406A this parameter is only used with the Standard or Short lists, and not with the Custom list.

Factory Preset: 100 kHz

Range: 1 kHz to 5 MHz

Default Unit: Hz

Remarks: You must be in the GSM, EDGE mode to use this command. Use INSTRument:SElect to set the mode.

GMSK Output RF Spectrum—Resolution BW for the Switching Transient Spectrum at the Carrier

```
[ :SENSe ] :ORFSpectrum: BANDwidth | BWIDth [ :RESolution ]  
:SWITching: CARRier <freq>
```

```
[ :SENSe ] :ORFSpectrum: BANDwidth | BWIDth [ :RESolution ]  
:SWITching: CARRier?
```

Selects the resolution bandwidth for the carrier when measuring spectrum due to switching transients.

This parameter is only used with the Standard or Short lists, and not with the Custom list.

Factory Preset: 300 kHz

Range: 1 kHz to 5 MHz

Default Unit: Hz

Remarks: You must be in the GSM, EDGE mode to use this command. Use INSTRument:SElect to set the mode.

GMSK Output RF Spectrum—Resolution BW For Switching Transients At Close Offsets

```
[ :SENSe ] :ORFSpectrum: BANDwidth | BWIDth [ :RESolution ]  
:SWITching: OFFSet: CLOSe <freq>
```

```
[ :SENSe ] :ORFSpectrum: BANDwidth | BWIDth [ :RESolution ]  
:SWITching: OFFSet: CLOSe?
```

Set the resolution bandwidth used for the spectrum due to switching transients part of the ORFS measurement for offset frequencies less

than 1800 kHz.

This parameter is only used with the Standard or Short lists, and not with the Custom list.

Factory Preset: 30 kHz

Range: 1 kHz to 5 MHz

Default Unit: Hz

Remarks: You must be in the GSM, EDGE mode to use this command. Use INSTRUMENT:SElect to set the mode.

GMSK Output RF Spectrum—Resolution BW For Switching Transients At Far Offsets

```
[ :SENSE ] :ORFSpectrum: BANDwidth | BWIDth [ :RESolution ]
:SWITChing: OFFSet: FAR <freq>
```

```
[ :SENSE ] :ORFSpectrum: BANDwidth | BWIDth [ :RESolution ]
:SWITChing: OFFSet: FAR?
```

Set the resolution bandwidth used for the spectrum due to switching transients part of the ORFS measurement for offset frequencies greater than or equal to 1800 kHz.

This parameter is only used with the standard or short lists, and not with the custom list.

Factory Preset: 30 kHz

Range: 1 kHz to 5 MHz

Default Unit: Hz

Remarks: You must be in the GSM, EDGE mode to use this command. Use INSTRUMENT:SElect to set the mode.

GMSK Output RF Spectrum—Break Frequency

```
[ :SENSE ] :ORFSpectrum: BRFrequency <freq>
```

```
[ :SENSE ] :ORFSpectrum: BRFrequency?
```

Set the direct time break frequency. An FFT measurement method is used for offsets below this break frequency. The direct time measurement method is used for offsets above the break frequency. See the chapter on making measurements for more information about these two methods.

Factory Preset: 600 kHz

Range: 0 kHz to 775 kHz

Default Unit: Hz
History: E4406A:
Added revision A.04.00 and later
Remarks: You must be in the GSM, EDGE mode to use this command. Use INSTRument:SELEct to set the mode.
Front Panel
Access: Meas Setup, Advanced, Direct Time Break Freq

GMSK Output RF Spectrum—Peak Detection mode

```
[[:SENSe]:ORFSpectrum:DETEctor:SWITching:FAST[:STATe]  
OFF|ON|0|1
```

```
[[:SENSe]:ORFSpectrum:DETEctor:SWITching?
```

Sets the detection mode to “fast peak”. This setting is available when the “measurement type” selected is Switching or Switching & Modulation.

Factory Preset: On

Remarks: You must be in the GSM, EDGE mode to use this command. Use INSTRument:SELEct to set the mode.

Front Panel
Access: Meas Setup, More, Advanced
State Saved: Saved in Instrument State

GMSK Output RF Spectrum—Define Custom Modulation Resolution Bandwidth List

```
[[:SENSe]:ORFSpectrum:LIST:MODulation:BANDwidth|BWIDth  
<res bw>{,<res bw>}
```

```
[[:SENSe]:ORFSpectrum:LIST:MODulation:BANDwidth|BWIDth?
```

Define the custom set of resolution bandwidths for the modulation spectrum part of the ORFS measurement. The first bandwidth specified is for the carrier. Each resolution bandwidth in this list corresponds to an offset frequency in the modulation offset frequency list. The number of items in each of these lists needs to be the same.

Factory Preset: Same as standard list

Range: 1 kHz to 5 MHz

Default Unit: Hz

Remarks: This command is only valid if SENS:ORFS:MEAS is set to multiple and the custom list type is selected with

SENS:ORFS:LIST:SEL CUST.

You must be in the GSM, EDGE mode to use this command. Use INSTRument:SElect to set the mode.

GMSK Output RF Spectrum—Define Custom Modulation Level Offsets

```
[[:SENSE]:ORFSpectrum:LIST:MODulation:LOFFset[:RCARrier]
<level>{,<level>}
```

```
[[:SENSE]:ORFSpectrum:LIST:MODulation:LOFFset[:RCARrier]?
```

Define the custom set of level offsets for the modulation spectrum part of the ORFS measurement. This allows you to modify the standard limits by adding a delta amplitude value to them. The first level offset specified must be 0 dB for the carrier. Each level offset in this list corresponds to an offset frequency in the modulation offset frequency list. The number of items in each of these lists needs to be the same.

Example: ORFS:LIST:MOD:FREQ 0,300e3,1.3e6,2.0e6

Sets custom offset freqs: 300 kHz, 1.3 MHz, 2 MHz

```
ORFS:LIST:MOD:BAND 30e3,30e3,30e3,100e3
```

Sets corresponding RBWs: 30 kHz, 30 kHz, 100 kHz

```
ORFS:LIST:MOD:LOFFset 0,-5,3,5
```

Assume the power level of the signal is -43 dBm, then the standard limits for these three offsets are: -42 dBc, -72 dBc, -75 dBc respectively. The loffset command adjusts these limits to: -47 (-42-5) dBc, -70 (-73+3) dBc, -70 (-75+5) dBc.

Factory Preset: 0 dB level offsets (limits remain the same as the standards)

Range: 0 to 50 dB

Default Unit: dB

Remarks: This command is only valid if SENS:ORFS:MEAS is set to multiple and the custom list type is selected with SENS:ORFS:LIST:SEL CUST.

You must be in the GSM, EDGE mode to use this command. Use INSTRument:SElect to set the mode.

History: E4406A:
Version A.03.00 or later

GMSK ORFS - Custom Modulation Absolute Limit Level Offsets

```
[ :SENSe ] :ORFSpectrum:LIST:MODulation:LOFFset:ABSolute  
<level>{ , <level> }
```

```
[ :SENSe ] :ORFSpectrum:LIST:MODulation:LOFFset:ABSolute?
```

| | |
|---------------|--|
| Mode: | GSM |
| Key Path: | Meas Setup |
| Unit: | DB |
| Default: | 0.0 |
| State Saved: | Saved in instrument state. |
| Resolution: | 0.1 dB |
| Example: | :SENSe:ORFSpectrum:LIST:MODulation:LOFFset:ABSolute 0.0, -2.0, -5.0 |
| Array Length: | Any number from 1 to 15 is acceptable as long as the following arrays have the same number of elements: Custom Switching Offset Frequency Custom Switching Resolution Band Width Custom Switching Relative Limit Level Offsets Custom Switching Absolute Limit Level Offsets Custom Switching Apply Limit Level Offsets |

GMSK ORFS - Custom Modulation State

```
[ :SENSe ] :ORFSpectrum:LIST:MODulation[:FREQuency] <offset  
freq>{ , <offset freq> }
```

```
[ :SENSe ] :ORFSpectrum:LIST:MODulation[:FREQuency] ?
```

```
[ :SENSe ] :ORFSpectrum:LIST:MODulation:STATe  
OFF | ON | 0 | 1 { , OFF | ON | 0 | 1 }
```

```
[ :SENSe ] :ORFSpectrum:LIST:MODulation:STATe?
```

| | |
|-----------------------|-------------------|
| Mode: | GSM |
| Key Path: | Meas Setup |
| Active Function Text: | Offset Freq |

| | |
|---------------------|--|
| Default Terminator: | Hz kHz MHz GHz |
| Factory Presets: | |
| Frequency: | 0.0, 1.0e5, 2.0e5, 2.5e5, 4.0e5, 6.0e5, 8.0e5, 1.0e6, 1.2e6, 1.4e6, 1.6e6, 1.8e6, 3.0e6, 6.0e6 |
| State: | 1, 1, 1, 1, 1, 1, 1, 1, 1, 1, 1, 1, 1, 1 |
| State Saved: | Saved in instrument state. |
| SCPI Resolution: | 1.0 Hz |
| Example: | :SENSe:ORFSpectrum:LIST:MODulation:FREQ uency 0.0, 1.0e5, 2.0e5 :SENSe:ORFSpectrum:LIST:MODulation:STATe ON, ON, ON |
| Array Length: | Any number from 1 to 15 is acceptable as long as the following arrays have the same number of elements: Custom Switching Offset Frequency Custom Switching Resolution Band Width Custom Switching Relative Limit Level Offsets Custom Switching Absolute Limit Level Offsets Custom Switching Apply Limit Level Offsets |

GMSK Output RF Spectrum—Offset Frequency List

```
[ :SENSe ] :ORFSpectrum:LIST:SElect CUSTom | SHORt | STANdard
```

```
[ :SENSe ] :ORFSpectrum:LIST:SElect?
```

Select the list of settings that are used to make the ORFS measurement. This specifies standard or customized lists and short lists. The lists contain the offset frequencies (and bandwidths) that are used for the modulation spectrum and transient spectrum parts of the ORFS measurement.

CUSTom - Uses the four user-defined lists that specify:

- Offset frequencies for modulation spectrum measurement
- Corresponding resolution bandwidths for each of the modulation offset frequencies
- Offset frequencies for switching transient spectrum measurement
- Corresponding resolution bandwidths for each of the switching transient offset frequencies

SHORt - A shortened list of the offset frequencies specified in the GSM Standards. It uses two internal offset frequency lists, one for modulation spectrum and the other for switching transient spectrum. These offset frequencies cannot be changed, but the

resolution bandwidths can be changed by other commands in the SENSE:ORFSpectrum subsystem.

STANdard - The complete list of the offset frequencies specified in the GSM Standards, except for those offsets greater than 6 MHz. It uses two internal offset frequency lists, one for modulation spectrum and the other for switching transient spectrum. These offset frequencies cannot be changed, but the resolution bandwidths can be changed by other commands in the SENSE:ORFSpectrum subsystem.

Factory Preset: SHORT

Remarks: This command is only valid if SENS:ORFS:MEAS is set to multiple.

If you change the number of custom offsets then the number of offset bandwidths, frequencies and level offsets must also be changed.

You must be in the GSM, EDGE mode to use this command. Use INSTRument:SElect to set the mode.

GMSK ORFS - Custom Switching Apply Limit Level Offsets

```
[[:SENSe]:ORFSpectrum:LIST:SWITching:APPLY  
<RELative|BOTH|ABSolute>{,<RELative|BOTH|ABSolute>}]
```

```
[[:SENSe]:ORFSpectrum:LIST:SWITching:APPLY?
```

| | |
|--------------|--|
| Mode: | GSM |
| Key Path: | Meas Setup |
| Default: | BOTH, BOTH, BOTH, BOTH, BOTH, BOTH, BOTH, BOTH, BOTH, BOTH, BOTH, BOTH, BOTH, BOTH, BOTH |
| State Saved: | Saved in instrument state. |
| Range: | Rel Both Abs |
| Example: | :SENSe:ORFSpectrum:LIST:SWITching:APPLY RELative, RELative, RELative |

Array Length: Any number from 1 to 15 is acceptable as long as the following arrays have the same number of elements:

- Custom Switching Offset Frequency
- Custom Switching Resolution Band Width
- Custom Switching Relative Limit Level Offsets
- Custom Switching Absolute Limit Level Offsets
- Custom Switching Apply Limit Level Offsets

GMSK Output RF Spectrum—Define Custom Switching Transient Resolution Bandwidth List

```
[ :SENSe ] :ORFSpectrum:LIST:SWITching: BANDwidth | BWIDth
<res_bw> { , <res_bw> }
```

```
[ :SENSe ] :ORFSpectrum:LIST:SWITching: BANDwidth | BWIDth?
```

Define the custom set of resolution bandwidths for the switching transient spectrum part of the ORFS measurement. The first bandwidth specified is for the carrier. Each resolution bandwidth in this list corresponds to an offset frequency in the switching transient offset frequency list. The number of items in each of these lists needs to be the same.

Factory Preset: Same as standard list

Range: 1 kHz to 5 MHz

Default Unit: Hz

Remarks: This command is only valid if SENS:ORFS:MEAS is set to multiple and the custom list type is selected with SENS:ORFS:LIST:SEL CUST.

You must be in GSM, EDGE mode to use this command. Use INSTRument:SElect to set the mode.

GMSK Output RF Spectrum—Define Custom Switching Transient Relative Limit Level Offsets

```
[ :SENSe ] :ORFSpectrum:LIST:SWITching: LOffset [ :RCARrier ]
<level> { , <level> }
```

```
[ :SENSe ] :ORFSpectrum:LIST:SWITching: LOffset [ :RCARrier ] ?
```

Define the custom set of level offsets for the switching transient spectrum part of the ORFS measurement. This allows you to modify the standard limits by adding a delta amplitude value to them. The first

level offset specified must be 0 dB for the carrier. Each level offset in this list corresponds to an offset frequency in the modulation offset frequency list. The number of items in each of these lists needs to be the same.

Example: See the ORFS:LIST:MOD:LOFF example above.

Factory Preset: 0 dB level offsets (limits remain the same as the standards)

Range: 0 to 50 dB

Default Unit: dB

Remarks: This command is only valid if SENS:ORFS:MEAS is set to multiple and the custom list type is selected with SENS:ORFS:LIST:SEL CUST.

You must be in GSM, EDGE mode to use this command. Use INSTRUMENT:SELEct to set the mode.

History: E4406A:
Version A.03.00 or later

GMSK ORFS - Custom Switching Absolute Limit Level Offsets

```
[ :SENSe ] :ORFSpectrum:LIST:SWITching:LOFFset:ABSolute  
<level>{ , <level> }
```

```
[ :SENSe ] :ORFSpectrum:LIST:SWITching:LOFFset:ABSolute?
```

Mode: GSM

Key Path: **Meas Setup**

Unit: DB

Default: 0.0

State Saved: Saved in instrument state.

Resolution: 0.1 dB

Example: :SENSe:ORFSpectrum:LIST:SWITching:LOFFset
:ABSolute 0.0, -2.0, -5.0

Array Length: Any number from 1 to 15 is acceptable as long as the following arrays have the same number of elements:

- Custom Switching Offset Frequency
- Custom Switching Resolution Band Width
- Custom Switching Relative Limit Level Offsets
- Custom Switching Absolute Limit Level Offsets
- Custom Switching Apply Limit Level Offsets

GMSK ORFS - Custom Switching State

```
[ :SENSE ] :ORFSpectrum:LIST:SWITching[:FREQUENCY] <offset freq>{ ,<offset freq> }
```

```
[ :SENSe ] :ORFSpectrum:LIST:SWITching[:FREQUENCY] ?
```

```
[ :SENSe ] :ORFSpectrum:LIST:SWITching:STATe  
OFF | ON | 0 | 1 { , OFF | ON | 0 | 1 }
```

```
[ :SENSe ] :ORFSpectrum:LIST:SWITching:STATe?
```

| | |
|-----------------------|---|
| Mode: | GSM |
| Key Path: | Meas Setup |
| Active Function Text: | Offset Freq |
| Default Terminator: | Hz kHz MHz GHz |
| Factory Presets: | |
| Frequency: | 0.0, 4.0e5, 6.0e5, 1.2e6, 1.8e6 |
| State: | 1, 1, 1, 1, 1 |
| State Saved: | Saved in instrument state. |
| SCPI Resolution: | 1.0 Hz |
| Example: | :SENSe:ORFSpectrum:LIST:SWITching:FREQuency 0.0, 1.0e5, 2.0e5 :SENSe:ORFSpectrum:LIST:SWITching:STATe ON, ON, ON |

Array Length: Any number from 1 to 15 is acceptable as long as the following arrays have the same number of elements:

- Custom Switching Offset Frequency
- Custom Switching Resolution Band Width
- Custom Switching Relative Limit Level Offsets
- Custom Switching Absolute Limit Level Offsets
- Custom Switching Apply Limit Level Offsets

GMSK Output RF Spectrum—Measure Offsets Measurement Method

`[:SENSe] :ORFSpectrum:MEASure?`

Select the measurement method to be used.

MULTiple - The measurement is done at all offsets in the offset frequency list.

SINGLE - The measurement is done at only one offset as determined by the offset frequency setting. This allows detailed examination of the time-domain waveform at the specified offset frequency.

Factory Preset: **MULTiple**

GMSK ORFS - Meas Method

`[:SENSe] :ORFSpectrum:MEASure MULTiple | SINGLE | SWEPT`

`[:SENSe] :ORFSpectrum:MEASure?`

Select the measurement method to be used.

MULTiple - The measurement is done at all offsets in the offset frequency list.

SINGLE - The measurement is done at only one offset as determined by the offset frequency setting. This allows detailed examination of the time-domain waveform at the specified offset frequency.

SWEPT - The measurement is done in the frequency domain. For output RF spectrum due to modulation it is done using time-gated spectrum analysis to sweep the analyzer with the gate turned on for the desired portion of the burst only.

Mode: GSM

| | |
|-----------------------------|---|
| Key Path: | Meas Setup |
| Factory Preset: | MULTiple |
| State Saved: | Saved in instrument state. |
| Range: | Multi-Offset Single Offset (Examine) Swept |
| Dependencies and Couplings: | Swept choice is available only if Meas Type is Modulation. Otherwise, the Swept choice is grayed out. If Swept is selected and Meas Type is not Modulation, the measurement algorithm internally assumes that Meas Method is Multi-Offset. |
| Example: | :SENSe:ORFSpectrum:MEASure MULTiple |

GMSK Output RF Spectrum—Offset Frequency

[:SENSe] :ORFSpectrum:OFrequency <freq>

[:SENSe] :ORFSpectrum:OFrequency?

Set the offset frequency that is used to measure a single offset. This command is only valid if SENS:ORFS:MEAS is set to single.

Factory Preset: 250 kHz

Range: -12.0 MHz to +12.0 MHz

Step Size: Steps through the values in the selected offset frequency list.

Default Unit: Hz

Remarks: You must be in the GSM, EDGE mode to use this command. Use INSTRument:SElect to set the mode.

GMSK Output RF Spectrum—Trigger Source

[:SENSe] :ORFSpectrum:TRIGger:SOURce EXTernal [1] | EXTernal2 | FRAMe | IMMEDIATE | RFBURSt

[:SENSe] :ORFSpectrum:TRIGger:SOURce?

Select the trigger source used to control the data acquisitions.

EXTernal 1 - Front panel external trigger input

EXTernal 2 - Rear panel external trigger input

FRAMe - Uses the internal frame timer, which has been synchronized to the selected burst sync

IMMEDIATE - The next data acquisition is immediately taken, capturing the signal asynchronously (also called free run)

RFBURST - Wideband RF burst envelope trigger that has automatic level control for periodic burst signals

Factory Preset: RFBURST if the RF Communications Hardware (option B7E) has been installed

EXTERNAL if option B7E has not been installed

Remarks: You must be in the GSM, EDGE mode to use this command. Use INSTRUMENT:SELECT to set the mode.

GMSK Output RF Spectrum—Measurement Type

```
[[:SENSe]:ORFSpectrum:TYPE  
MODulation|MSWitching|SWITching|FFModulation
```

```
[[:SENSe]:ORFSpectrum:TYPE?
```

Select the measurement type.

MODulation - Only the modulation spectrum is measured.

MSWitching (Modulation & Switching) - Both modulation and switching transient spectrums are measured.

SWITching - Only the switching transient spectrum is measured.

FFModulation- Full frame modulation improves measurement speed by acquiring a full frame of data prior to performing the FFT calculation. FFT modulation can only be used if all slots in the transmitted frame are active.

Factory Preset: MODulation

Remarks: You must be in the GSM, EDGE mode to use this command. Use INSTRUMENT:SELECT to set the mode.

History: Added in version A.05.00

GMSK Phase & Frequency Error Measurement

Commands for querying the phase and frequency error measurement results and for setting to the default values are found in the “[MEASure Group of Commands](#)” on page 347. The equivalent front panel keys for the parameters described in the following commands, are found under the **Meas Setup** key, after the **GMSK Phase & Freq** measurement has been selected from the **MEASURE** key menu.

Phase & Frequency Error—Number Of Bursts Averaged

`[:SENSE] :PFError:AVERage:COUNT <integer>`

`[:SENSE] :PFError:AVERage:COUNT?`

Set the number of bursts that are averaged. After the specified number of bursts (average counts), the averaging mode (termination control) setting determines the averaging action.

Factory Preset: 15

Range: 1 to 1,000

Remarks: You must be in the GSM, EDGE mode to use this command. Use `INSTRument:SElect` to set the mode.

Phase & Frequency Error—Averaging State

`[:SENSE] :PFError:AVERage [:STATE] OFF | ON | 0 | 1`

`[:SENSE] :PFError:AVERage [:STATE] ?`

Turn averaging on or off.

Factory Preset: OFF

Remarks: You must be in the GSM, EDGE mode to use this command. Use `INSTRument:SElect` to set the mode.

Phase & Frequency Error—Averaging Termination Control

`[:SENSE] :PFError:AVERage:TCONtrol EXPonential | REPEAT`

`[:SENSE] :PFError:AVERage:TCONtrol?`

Select the type of termination control used for the averaging function. This determines the averaging action after the specified number of bursts (average count) is reached.

EXPonential - After the average count has been reached, each successive data acquisition is exponentially weighted and combined with the existing average.

REPEAT - After reaching the average count, the averaging is reset and a new average is started.

Factory Preset: REPEAT

Remarks: You must be in the GSM, EDGE mode to use this command. Use `INSTRument:SElect` to set the mode.

Phase & Frequency Error—Averaging Type

```
[ :SENSe ] :PFError:AVERage:TYPE MEAN|MAXimum
```

```
[ :SENSe ] :PFError:AVERage:TYPE?
```

Select the type of averaging:

MEAN - The scalar results are averaged.

MAXimum - The maximum scalar results are retained.

Factory Preset: MAXimum.

Remarks: For E4406A you must be in GSM, EDGE mode to use this command. Use INSTRument:SElect to set the mode.

Remarks: For PSA you must be in the GSM, or EDGE mode to use this command. Use INSTRument:SElect to set the mode.

Phase & Frequency Error—I/Q Origin Offset Measurement

```
[ :SENSe ] :PFError:IQOffset [:STATe] OFF|ON|0|1
```

```
[ :SENSe ] :PFError:IQOffset [:STATe] ?
```

Turn On or Off I/Q origin offset measurement. If it is set to On, I/Q origin offset is performed. When it is set to Off, the measurement is not performed, but the measurement speed is improved.

Factory Preset: On

On - I/Q origin offset measurement is performed.

Off - I/Q origin offset measurement is not performed.

Remarks: You must be in the GSM, EDGE mode to use this command. Use INSTRument:SElect to set the mode.

Phase & Frequency Error—Burst Synchronization

```
[ :SENSe ] :PFError:BSYNc:SOURce
```

```
EXTernal [1] | EXTernal2 | NONE | RFBurst | TSEQUence
```

```
[ :SENSe ] :PFError:BSYNc:SOURce?
```

Select the method of synchronizing the measurement to the GSM bursts.

EXTernal 1 - Burst sync at front panel external trigger input

EXTernal 2 - Burst sync at rear panel external trigger input

TSEQUence (Training Sequence) - The training sequence burst sync

performs a demodulation of the burst and determines the start and stop of the useful part of the burst based on the midamble training sequence.

RFBurst - The RF amplitude burst sync approximates the start and stop of the useful part of the burst without demodulation of the burst.

None - No burst synchronization is used

Factory Preset: TSEQUence

Remarks: You must be in the GSM, EDGE mode to use this command. Use INSTRUMENT:SElect to set the mode.

Phase & Frequency Error—Trace Data

`[:SENSE] :PFError:TRACe [:STATe] OFF | ON | 0 | 1`

`[:SENSe] :PFError:TRACe [:STATe] ?`

Turn On or Off trace data for phase and frequency error measurement. If it is set to On, the trace data is available. When it is set to Off, the trace data is not available, but the measurement speed is improved.

Factory Preset: On

On - Trace data is available.

Off - Trace data is not available.

Remarks: You must be in the GSM, EDGE mode to use this command. Use INSTRUMENT:SElect to set the mode.

Phase & Frequency Error—Trigger Source

`[:SENSe] :PFError:TRIGger:SOURce EXTernal [1] | EXTernal2 | FRAMe | IF | IMMEDIATE | RFBURst`

`[:SENSe] :PFError:TRIGger:SOURce?`

Select the trigger source used to control the data acquisitions.

EXTernal 1 - Front panel external trigger input.

EXTernal 2 - Rear panel external trigger input.

FRAMe - Uses the internal frame timer, which has been synchronized to the selected burst sync.

IF - Internal IF envelope (video) trigger.

IMMEDIATE - The next data acquisition is immediately taken, capturing the signal asynchronously (also called free run).

RFBurst - Wideband RF burst envelope trigger that has automatic level control for periodic burst signals.

Factory Preset: RFBurst

Remarks: You must be in the GSM, EDGE mode to use this command. Use INSTRument:SELEct to set the mode.

Select I/Q Power Range (E4406A only)

```
[ :SENSe ] :POWer :IQ :RANGe [ :UPPer ] <Float 64> {DBM} | DBMV | W
```

```
[ :SENSe ] :POWer :IQ :RANGe [ :UPPer ] ?
```

Selects maximum total power expected from unit under test at test port when I or Q port is selected.

Range: For 50 Ohms:

13.0, 7.0, 1.0, -5.1 [DBM]
60.0, 54.0, 48.0, 41.9 [DBMV]
0.02, 0.005, 0.0013, 0.00031 [W]

For 600 Ohms:

2.2, -3.8, -9.8, -15.8 [DBM]
60.0, 54.0, 48.0, 41.9 [DBMV]
0.0017, 0.00042, 0.0001, 0.000026 [W]

Values for 1 M Ohm vary according to selected reference impedance.

Remarks: Implemented for BASIC and W-CDMA modes.

History: Version A.05.00 or later

Select I/Q Voltage Range (E4406A only)

```
[ :SENSe ] :VOLTage :IQ :RANGe [ :UPPer ] <Float 64> [V]
```

```
[ :SENSe ] :VOLTage :IQ :RANGe [ :UPPer ] ?
```

Selects upper voltage range when I or Q port is selected. This setting helps set the gain which is generated in the variable gain block of the BbIQ board to improve dynamic range.

Range: 1.0, 0.5, 0.025, 0.125[V]

Remarks: Implemented for BASIC and W-CDMA modes.

History: Version A.05.00 or later

RF Power Commands

RF Port Input Attenuation

```
[ :SENSE ] :POWER [ :RF ] :ATTenuation <rel_power>
```

```
[ :SENSE ] :POWER [ :RF ] :ATTenuation?
```

Sets the RF input attenuator. This value is set at its auto value if RF input attenuation is set to auto.

Factory Preset: 0 dB

12 dB for iDEN (E4406A)

Range: 0 to 40 dB

Default Unit: dB

Front Panel

Access: **Input, Input Atten**

Internal Preamp State

```
[ :SENSE ] :POWER [ :RF ] :GAIN [ :STATE ] ON | OFF
```

```
[ :SENSE ] :POWER [ :RF ] :GAIN [ :STATE ] ?
```

Mode: GSM

Factory Preset: OFF

State Saved: Saved in instrument state.

Range: ON | OFF

Remote Command Notes: This SCPI command setting is available in EDGE EVM measurement or GSM PFER measurement.

Example: :SENSE:POW:RF:GAIN on

Mode: GSM

Factory Preset: 0

State Saved: Saved in instrument state.

Range: 0 to 20

SCPI Resolution: 10

Remote Command This SCPI command setting is only available in
Notes: EDGE EVM measurement or GSM PFER
 measurement.

Example: :SENSe:POW:RF:GAIN on

RF Port Power Range Auto

[:SENSe] :POWer [:RF] :RANGe:AUTO OFF | ON | 0 | 1

[:SENSe] :POWer [:RF] :RANGe:AUTO?

Selects the RF port power range to be set either automatically or manually.

ON - Power range is automatically set as determined by the actual measured power level at the start of a measurement.

OFF - Power range is manually set

Factory Preset: ON

Remarks: You must be in the cdmaOne, GSM, EDGE, NADC,
 PDC, cdma2000, W-CDMA, iDEN, or WiDEN mode to
 use this command. Use INSTRument:SElect to set the
 mode.

Front Panel

Access: **Input, Max Total Pwr (at UUT)**

RF Port Power Range Maximum Total Power

[:SENSe] :POWer [:RF] :RANGe [:UPPer] <power>

[:SENSe] :POWer [:RF] :RANGe [:UPPer] ?

Sets the maximum expected total power level at the radio unit under test. This value is ignored if RF port power range is set to auto. External attenuation required above 30 dBm.

Factory Preset: -15.0 dBm

Range: -100.0 to 80.0 dBm for EDGE, GSM
 -100.0 to 27.7 dBm for cdmaOne, iDEN (E4406A)
 -200.0 to 50.0 dBm for NADC, PDC
 -200.0 to 100.0 dBm for cdma2000, W-CDMA

Default Unit: dBm

Remarks: Global to the current mode. This is coupled to the RF
 input attenuation

For E4406A you must be in the Service, cdmaOne, EDGE(w/GSM), GSM, iDEN, NADC, PDC, cdma2000, or W-CDMA mode to use this command. Use INSTRument:SElect to set the mode.

For PSA you must be in the cdmaOne, GSM, EDGE, NADC, PDC, cdma2000, or W-CDMA mode to use this command. Use INSTRument:SElect to set the mode.

Front Panel
Access:

Input, Max Total Pwr (at UUT)

GMSK Power vs. Time Measurement

Commands for querying the power versus time measurement results and for setting to the default values are found in the “[MEASure Group of Commands](#)” on page 347. The equivalent front panel keys for the parameters described in the following commands, are found under the **Meas Setup** key, after the **GMSK Pwr vs Time** measurement has been selected from the **MEASURE** key menu.

Power vs. Time—Number of Bursts Averaged

```
[ :SENSe ] :PVTime:AVERAge:COUNT <integer>
```

```
[ :SENSe ] :PVTime:AVERAge:COUNT?
```

Sets the number of bursts that are averaged. After the specified number of bursts (average counts), the averaging mode (termination control) setting determines the averaging action.

Factory Preset: 15

16 for iDEN, WiDEN

100 for 1xEV-DO

Range: 1 to 10,000

Remarks: For E4406A you must be in the EDGE(w/GSM), GSM, 1xEV-DO, W-CDMA, iDEN, WiDEN, or Service mode to use this command. Use INSTRument:SElect to set the mode.

For PSA you must be in the GSM, EDGE, 1xEV-DO or W-CDMA mode to use this command. Use INSTRument:SElect to set the mode.

Power vs. Time—Averaging State

```
[ :SENSe ] :PVTime:AVERAge [ :STATe ] OFF | ON | 0 | 1
```

```
[ :SENSe ] :PVTime:AVERAge [ :STATe ] ?
```

Turns averaging on or off.

Factory Preset: OFF

ON for 1xEV-DO, W-CDMA

Remarks: For E4406A you must be in the EDGE(w/GSM), GSM, 1xEV-DO, W-CDMA, or Service mode to use this command. Use INSTRument:SElect to set the mode.

For PSA you must be in the GSM, EDGE, 1xEV-DO or W-CDMA mode to use this command. Use

INSTRument:SElect to set the mode.

Power vs. Time—Averaging Termination Control

`[:SENSE] :PVTime:AVERAge:TCONtrol EXPonential | REPEAT`

`[:SENSE] :PVTime:AVERAge:TCONtrol?`

Selects the type of termination control used for the averaging function. This specifies the averaging action after the specified number of bursts (average count) is reached.

EXPonential - After the average count has been reached, each successive data acquisition is exponentially weighted and combined with the existing average.

REPEAT - After reaching the average count, the averaging is reset and a new average is started.

Factory Preset: EXPonential

REPEAT for 1xEV-DO, W-CDMA

Remarks: For E4406A you must be in the EDGE(w/GSM), GSM, 1xEV-DO, W-CDMA, or Service mode to use this command. Use INSTRument:SElect to set the mode.

For PSA you must be in the GSM, EDGE, 1xEV-DO or W-CDMA mode to use this command. Use INSTRument:SElect to set the mode.

Power vs. Time—Averaging Type

EDGE (w / GSM), GSM, Service GSM, EDGE mode

`[:SENSE] :PVTime:AVERAge:TYPE
LOG | MAXimum | MINimum | MXMinimum | RMS`

iDEN, WiDEN mode

`[:SENSE] :PVTime:AVERAge:TYPE
LOG | MAXimum | MINimum | MXMinimum | RMS | POWer`

1xEV-DO mode

`[:SENSE] :PVTime:AVERAge:TYPE LOG | MAXimum | MINimum | RMS | SCALar`

W-CDMA mode

`[:SENSE] :PVTime:AVERAge:TYPE RMS | MAXimum | MINimum`

`[:SENSE] :PVTime:AVERAge:TYPE?`

Selects the type of averaging to be performed.

LOG - The log of the power is averaged. (This is also known as video averaging.)

MAXimum - The maximum values are retained.

MINimum - The minimum values are retained.

MXMinimum - Both the maximum and the minimum values are retained. (E4406A - EDGE(W/GSM), GSM, and Service modes, and PSA - GSM, EDGE, and 1xEV-DO modes only)

RMS - The power is averaged to provide a voltage rms value.

SCALar - The amplitude level of power is averaged to provide a voltage value. (1xEV-DO mode only)

POWER - averages the linear power of successive measurements.

Factory Preset: RMS

Remarks: For E4406A you must be in the EDGE(w/GSM), GSM, 1xEV-DO, W-CDMA, iDEN, WiDEN or Service mode to use this command. Use INSTRUMENT:SElect to set the mode.

For PSA you must be in the GSM, EDGE, 1xEV-DO, or W-CDMA mode to use this command. Use INSTRUMENT:SElect to set the mode.

Power vs. Time—Resolution BW

```
[[:SENSe]:PVTTime:BANDwidth|BWIDth[:RESolution] <freq>
```

```
[[:SENSe]:PVTTime:BANDwidth|BWIDth[:RESolution]?
```

Enables you to set the resolution bandwidth. This is an advanced control that normally does not need to be changed. Setting this to a value other than the factory default, may cause invalid measurement results.

Factory Preset: 500 kHz 1.5 MHz

5.0 MHz for W-CDMA

30 kHz for iDEN

120 kHz for WiDEN

Range: 1 kHz to 5 MHz

1.0 kHz to 10.0 MHz when PVT:BAND:RES:TYPE is set to FLATtop

1.0 kHz to 8.0 MHz when PVT:BAND:RES:TYPE is set to GAUSSian

Default Unit: Hz

Remarks: For E4406A you must be in the EDGE(w/GSM), GSM, Service, 1xEV-DO, iDEN, WiDEN, or W-CDMA mode to use this command. Use INSTRUMENT:SElect to set the mode.

For PSA you must be in the GSM, EDGE, 1xEV-DO, or W-CDMA mode to use this command. Use INSTRUMENT:SElect to set the mode.

Front Panel

Access: **Meas Setup, Advanced, Res BW**

Power vs. Time—RBW Filter Type

```
[ :SENSE ] :PVTime: BANDwidth | BWIDth [ :RESolution ] :TYPE  
FLATtop | GAUSSian
```

```
[ :SENSE ] :PVTime: BANDwidth | BWIDth [ :RESolution ] :TYPE?
```

Enables you to select the type of resolution bandwidth filter. This is an advanced control that normally does not need to be changed. Setting this to a value other than the factory default, may cause invalid measurement results.

FLATtop - A filter with a flat amplitude response, which provides the best amplitude accuracy.

GAUSSian - A filter with Gaussian characteristics, which provides the best pulse response.

Factory Preset: GAUSSian

FLATtop for 1xEV-DO, W-CDMA, WiDEN

Remarks: For E4406A you must be in the EDGE(w/GSM), GSM, Service, 1xEV-DO, iDEN, WiDEN, or W-CDMA mode to use this command. Use INSTRUMENT:SElect to set the mode.

For PSA you must be in the GSM, EDGE, 1xEV-DO, or W-CDMA mode to use this command. Use INSTRUMENT:SElect to set the mode.

Front Panel Access: **Meas Setup, Advanced (WiDEN).**

GMSK P_vT Timeslot Length

```
[ :SENSE ] :PVTime: BSYNc: SLENgth EVEN | INTEger
```

```
[ :SENSE ] :PVTime: BSYNc: SLENgth?
```

| | |
|-----------------------------|--|
| Mode: | GSM |
| Key Path: | Meas Setup, More, Advanced |
| Factory Preset: | INTeger |
| State Saved: | Saved in instrument state. |
| Range: | All 156.25 symb 157/156 symb |
| Dependencies and Couplings: | This parameter is available only if the Burst Sync type is None. |
| Example: | :SENSe:PVTime:BSYNc:SLENgth INTeger |

GMSK PvT Burst Synchronization Source

```
[ :SENSe ] :PVTime:BSYNc:SOURce TSEquence | RFBurst | NONE
[ :SENSe ] :PVTime:BSYNc:SOURce?
```

This parameter specifies how the measurement algorithm synchronizes the reference time with the given signal.

| | |
|---------------------------------------|---|
| KEY Training Seq SCPI TSEquence | The measurement algorithm first searches bursts and then searches training sequence (midamble) of each burst to determine the reference time for the limit mask. The reference time is adjusted slot-by-slot. |
| KEY RF Amptd SCPI RFBurst | The measurement algorithm calculates the burst width and determines the reference time for the limit mask so that the t0 comes to the center of each burst. The reference time is adjusted slot-by-slot. |
| KEY None (Trigger Delay) SCPI NONE | The measurement algorithm does not search bursts at all. The timing to capture data is determined by user-defined Trigger Delay. |

| | |
|-----------------|----------------------------|
| Mode: | GSM |
| Key Path: | Meas Setup |
| Factory Preset: | TSEquence |
| State Saved: | Saved in instrument state. |

| | |
|----------|--|
| Range: | Training Seq RF Amptd None (Trigger Delay) |
| Notes: | None choice is always available. However, the choice is meaningful only if the Trig Source is Ext Front or Ext Rear. |
| Example: | :SENSE:PVTime:BSYNc:SOURce TSEquence |

Power vs. Time—Limit Mask Display

```
[ :SENSE ] :PVTime:LIMit:MASK OFF | ON | 0 | 1
```

```
[ :SENSE ] :PVTime:LIMit:MASK?
```

Shows or hides the limit mask. Does not affect the pass/fail calculation for limit tests.

Factory Preset: ON

Remarks: You must be in GSM, EDGE, 1xEV-DO, or W-CDMA mode to use this command. Use INSTRument:SElect to set the mode.

Power vs. Time—Lower Mask Absolute Amplitude Levels

```
[ :SENSE ] :PVTime:MASK:LIST:LOWer:ABSolute  
<power>, <power>, <power>, <power>, <power>, . . .
```

```
[ :SENSE ] :PVTime:MASK:LIST:LOWer:ABSolute?
```

Allows you to enter a power level for any mask line segment that requires an absolute minimum power limit in addition to its relative limit. Each time a measurement is made the Ref Level is determined. (This is the power level of the useful part of the burst, or midway between the upper/lower masks). As the power of the Ref Level changes, all of the relative mask power levels change by the same amount.

Each relative limit is then compared to the Ref Level and an equivalent absolute power level is calculated. This power level is compared to the specified absolute limit for each line segment. If this calculated relative limit is lower than the absolute limit you've specified, then the value of the absolute limit is used for this segment. Therefore, if the absolute limit is set to a very low value (–200 dBm), the calculated value of the reference limit will never be lower, and the specified relative limit is always used for that segment. See [Figure 2 on page 471](#).

Every time point you defined with PVT:MASK:LOW:TIME must have a power value defined in the same order. You can put a comma in the SCPI command as a place holder for any points where an absolute

power is not specified, and that segment then uses the default value.

Factory Preset: Selected GSM standard

Range: -200 dBm to +100 dBm

Default Unit: dBm

Remarks: You must be in GSM, EDGE, iDEN, or WiDEN mode to use this command. Use INSTRUMENT:SElect to set the mode.

History: E4406A: Added in revised A.03.00 and later

Power vs. Time—Lower Mask Points

`[:SENSe] :PVTime:MASK:LIST:LOWer:POINTs?`

Queries the number of elements in the lower mask. This value is determined by the number of time points entered using

`[:SENSe] :PVTime:MASK:LIST:LOWer:TIME.`

Range: Integer, 1 to 25

Remarks: You must be in GSM, EDGE, iDEN, or WiDEN mode to use this command. Use INSTRUMENT:SElect to set the mode.

History: E4406A: Added in revision A.03.00

Power vs. Time—Lower Mask Relative Amplitude Levels

`[:SENSe] :PVTime:MASK:LIST:LOWer:RELative
<rel_power>,<rel_power>,<rel_power>,<rel_power>,<rel_power>
,...`

`[:SENSe] :PVTime:MASK:LIST:LOWer:RELative?`

Allows you to enter the relative power level for each horizontal line segment in the lower limit mask. There should be a power level for each time point entered using `[:SENSe] :PVTime:MASK:LIST:LOWer:TIME`, and they must be entered in the same order. These power levels are all relative to the defined Reference Power Level (the average power in the useful part of the data). When an upper and lower limit masks have been defined, the Reference Power Level is the mid-point between these two limits at time t_0 .

Any portion of the signal that has no limit line segment defined for it, defaults to a very low limit (-100 dB relative to the reference power). This prevents the measurement from indicating a failure for that portion of the data.

Factory Preset: Selected standard

–100.0, –100.0, –2.5, –100.0, and –100.0 dB for
1xEV-DO

–100.0, –100.0, –1.0, –100.0, and –100.0 dB for
W-CDMA

Range: –100 to 200 dB relative to the reference power

Default Unit: dB

Remarks: You must be in GSM, EDGE, 1xEV-DO, iDEN, WiDEN,
or W-CDMA mode to use this command. Use
INSTRUMENT:SElect to set the mode.

History: E4406A: Added in revision A.03.00

Power vs. Time—Lower Mask Time Points

```
[ :SENSE ] :PVTIME:MASK:LIST:LOWER:TIME <seconds>{ , <seconds> }
```

```
[ :SENSE ] :PVTIME:MASK:LIST:LOWER:TIME?
```

Allows you to enter the time points that define the horizontal line segments of the lower limit. A reference point designated “ t_0 ” is at the center of the useful data (usually the center of the burst). Each line segment to the right of the t_0 reference point is designated as a positive time value and each segment to the left of t_0 is a negative time value.

First enter positive values in sequence starting from t_0 , then negative values in sequence starting from t_0 . See [Figure 2 on page 471](#) and the PVT:MASK:LIST:UPPER:TIME example below it. (This is an upper mask example, but they work the same.)

We recommend that you select a large time value for your first and last mask points (e.g. –1 and +1 second). This guarantees that you have defined a limit for all the measured data. (See Mask Segments 4 and 9 in the [Table on page 472](#) for an example.

Factory Preset: Selected standard

Range: –1s to +1s, referenced to t_0 at the center of the useful
data (burst center)

1 to 25 time points in a mask

Default Unit: seconds

Remarks: You must be in GSM, EDGE, iDEN, WiDEN mode to
use this command. Use INSTRUMENT:SElect to set the
mode.

History: E4406A: Added in revision A.03.00

Power vs. Time—Upper Mask Absolute Amplitude Levels

```
[ :SENSe ] :PVTTime:MASK:LIST:UPPer:ABSolute  
<power>, <power>, <power>, <power>, <power>, . . .
```

```
[ :SENSe ] :PVTTime:MASK:LIST:UPPer:ABSolute?
```

Allows you to enter a power level for any mask line segment that requires an absolute minimum power limit in addition to its relative limit. Each time a measurement is made the Ref Level is determined. (This is the power level of the useful part of the burst, or midway between the upper/lower masks). As the power of the Ref Level changes, all of the relative mask power levels change by the same amount.

Each relative limit is then compared to the Ref Level and an equivalent absolute power level is calculated. This power level is compared to the specified absolute limit for each line segment. If this calculated relative limit is lower than the absolute limit you've specified, then the value of the absolute limit is used for this segment. Therefore, if the absolute limit is set to a very low value (–200 dBm), the calculated value of the reference limit will never be lower, and the specified relative limit is always used for that segment. See [Figure 2 on page 471](#).

Every time point you defined with PVT:MASK:LOW:TIME must have a power value defined in the same order. You can put a comma in the SCPI command as a place holder for any points where an absolute power is not specified, and that segment then uses the default value.

Example: PVT:MASK:LIST:UPP:ABS
 -200, -200, -58, -200, -200, -200, -200, -58, -200

Factory Preset: Selected standard

Range: –200 dBm to +100 dBm

Default Unit: dBm

Remarks: You must be in GSM, EDGE, iDEN, WiDEN mode to use this command. Use INSTRUMENT:SElect to set the mode.

History: E4406A: Added in revision A.03.00

Power vs. Time—Upper Mask Points

```
[ :SENSe ] :PVTTime:MASK:LIST:UPPer:POINTs?
```

Queries the number of elements in the upper mask. This value is determined by the number of time points entered using

```
[ :SENSe ] :PVTTime:MASK:LIST:UPPer:TIME.
```

Range: integer, 1 to 25

Remarks: You must be in GSM, EDGE, iDEN, WiDEN mode to use this command. Use INSTRUMENT:SELEct to set the mode.

History: E4406A: Added in revision A.03.00

Power vs. Time—Upper Mask Relative Amplitude Levels

```
[ :SENSE ] :PVTime:MASK:LIST:UPPER:RELATIVE <rel_power>,
<rel_power>, <rel_power>, <rel_power>, ...
```

```
[ :SENSE ] :PVTime:MASK:LIST:UPPER:RELATIVE?
```

Allows you to enter the relative power level for each horizontal line segment in the upper limit mask. There should be a power level for each time point entered using [:SENSE] :PVTime:MASK:LIST:UPPER:TIME, and they must be entered in the same order. These power levels are all relative to the defined Reference Power Level (the average power in the useful part of the data). When an upper and lower limit masks have been defined, the Reference Power Level is the mid-point between these two limits at time t_0 . See [Figure 2 on page 471](#).

Figure 2 Custom Upper Limit Mask Example

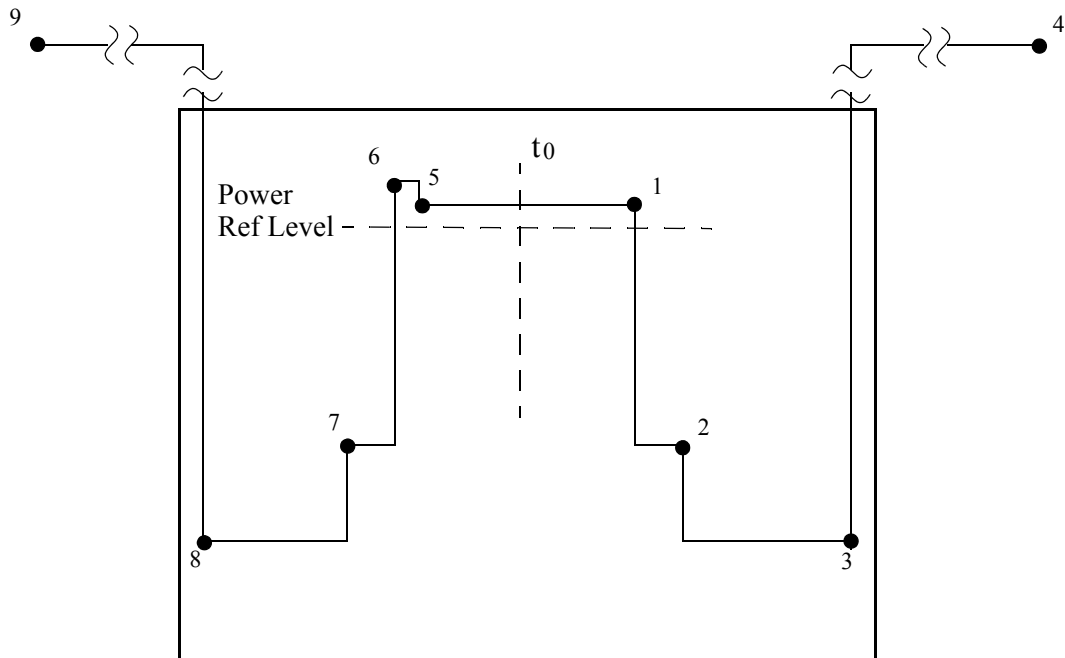

| Entered Value for each Time Segment | Absolute Time Value | Relative Power (example with Ref Level = -12 dBm) | | Entered Absolute Power (dBm) | Segment Number |
|-------------------------------------|---------------------|---|---------------------------|------------------------------|----------------|
| | | Entered Relative Power | Equivalent Absolute Power | | |
| 280.0e-6 | 280 μ s | +4 dBc | -8 dBm | -200 dBm | 1 |
| 15.0e-6 | 295 μ s | -32 dBc | -44 dBm | -200 dBm | 2 |
| 450.0e-6 | 745 μ s | -48 dBc | -60 dBm ^a | -58 dBm ^a | 3 |
| 1 | >1 sec | +100 dBc | +88 dBm | -200 dBm | 4 |
| -270.0e-6 | -270 μ s | +4 dBc | -8 dBm | -200 dBm | 5 |
| -10.0e-6 | -280 μ s | +7 dBc | -5 dBm | -200 dBm | 6 |
| -20.0e-6 | -300 μ s | -25 dBc | -37 dBm | -200 dBm | 7 |
| -450e-6 | -750 μ s | -43 dBc | -55 dBm | -58 dBm | 8 |
| -1 | <-1 sec | +100 dBc | +88 dBm | -200 dBm | 9 |

a. Notice that this segment, with this value of Ref Level, has a calculated relative level of -60 dBm. This is lower than the specified absolute level of -58 dBm, so the -58 dBm value is used as the test limit for the segment.

Example: PVT:MASK:LIST:UPP:REL
4,-32,-48,100,4,7,-25,-43,100

Factory Preset: Selected standard

-7.0, 2.5, 2.5, 2.5, and 7.5 dB for 1xEV-DO

-40.0 dB, 2.0 dB, 1.0 dB, 2.0 dB, -40.0 dB for W-CDMA

Range: -100 to +200 dB relative to the reference power

Default Unit: dB

Remarks: You must be in GSM, EDGE, 1xEV-DO, iDEN, WiDEN or W-CDMA mode to use this command. Use INSTRUMENT:SELEct to set the mode.

History: E4406A: Added in revision A.03.00

Power vs. Time—Upper Mask Time Points

[[:SENSe]:PVTime:MASK:LIST:UPPer:TIME
<seconds>,<seconds>,<seconds>,<seconds>,<seconds>,...

[[:SENSe]:PVTime:MASK:LIST:UPPer:TIME?

Allows you to enter the time points that define the horizontal line segments of the upper limit. A reference point designated “ t_0 ” is at the center of the useful data (usually the center of the burst). Each line segment to the right of the t_0 reference point is designated as a positive time value and each segment to the left of t_0 is a negative time value.

First enter positive values in sequence starting from t_0 , then the negative values in sequence starting from t_0 . See [Figure 2 on page 471](#) and the `PVTime:MASK:LIST:UPPER:TIME` example below it.

We recommend that you select a large time value for your first and last mask points (e.g. -1 and +1 second). This guarantees that you have defined a limit for all the measured data. (See Mask Segments 4 and 9 in the table [Table on page 472](#) for an example.

Example: `PVTime:MASK:LIST:UPPER:TIME`
`280e-6,15e-6,450e-6,1,-270e-6,-10e-6,-20e-6,-450e-6,-1`

Factory Preset: Selected standard

Range: -1s to +1s, referenced to t_0 at the center of the useful data (burst center)
 1 to 25 time points in a mask

Default Unit: seconds

Remarks: You must be in GSM, EDGE, iDEN, WiDEN mode to use this command. Use `INSTRUMENT:SELECT` to set the mode.

History: E4406A: Added in revision A.03.00

Power vs. Time—Custom Limit Masks

`[:SENSE] :PVTime:MASK:SElect STANDARD|CUSTOM`

`[:SENSe] :PVTime:MASK:SElect?`

Selects standard or user-defined custom masks to compare measured data against. See [“GMSK PvT Custom Limit Mask Example of Two Consecutive Bursts” on page 473](#).

Factory Preset: STANdard

Remarks: You must be in GSM, EDGE, iDEN, WiDEN mode to use this command. Use `INSTRUMENT:SELECT` to set the mode.

GMSK PvT Custom Limit Mask Example of Two Consecutive Bursts

Figure 4-5 GMSK PvT Custom Limit Mask Example of Two Consecutive

Bursts

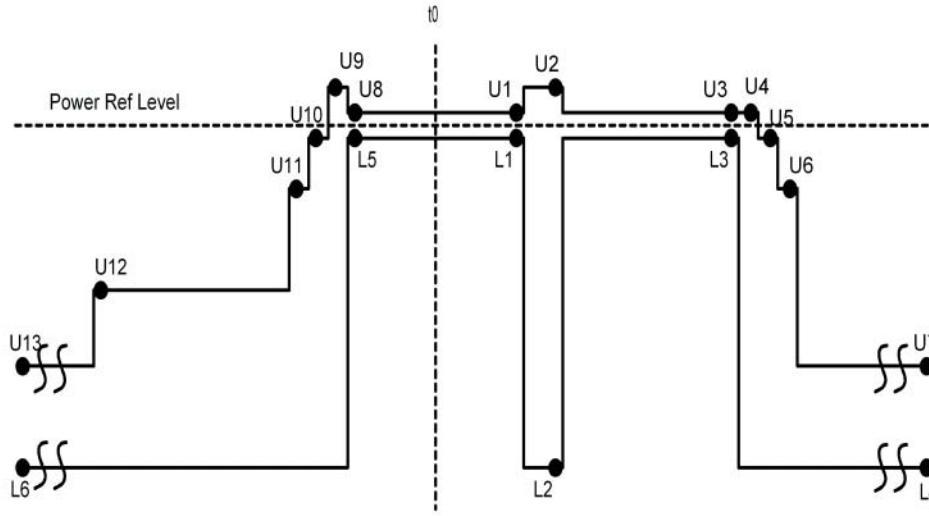

Upper Mask

| Segment Number | Timing | Relative Limit Level | Absolute Limit Level |
|----------------|---------------------|----------------------|----------------------|
| U1 | 271.384615e-6 | 1.0 | -200.0 |
| U2 | 33.23e-6 | 4.0 | -200.0 |
| U3 | 542.76923e-6 | 1.0 | -200.0 |
| U4 | 10.0e-6 | 1.0 | -200.0 |
| U5 | 8.0e-6 | -6.0 | -200.0 |
| U6 | 10.0e-6 | -30.0 | -17.0 |
| U7 | 1.0 (large enough) | -59.0 | -54.0 |
| U8 | -271.384615e-6 | 1.0 | -200.0 |
| U9 | -10.0e-6 | 4.0 | -200.0 |
| U10 | -8.0e-6 | -6.0 | -200.0 |
| U11 | -10.0e-6 | -30.0 | -17.0 |
| U12 | -576.0e-6 | -59.0 | -36.0 |
| U13 | -1.0 (large enough) | -59.0 | -54.0 |

Lower Mask

| Segment Number | Timing | Relative Limit Level | Absolute Limit Level |
|----------------|---------------------|----------------------|----------------------|
| L1 | 271.384615e-6 | -1.0 | -200.0 |
| L2 | 33.23e-6 | -200.0 | -200.0 |
| L3 | 542.76923e-6 | -1.0 | -200.0 |
| L4 | 1.0 (large enough) | -200.0 | -200.0 |
| L5 | -271.384615e-6 | -1.0 | -200.0 |
| L6 | -1.0 (large enough) | -200.0 | -200.0 |

Sample SCPI Sequence to Define The Above Mask

```

:SENSe:PVTime:MASK:SElect CUST
:SENSe:PVTime:SWEp:TIME 3
:SENSe:PVTime:MASK:LIST:UPPer:TIME
271.384615e-6, 33.23e-6, 542.76923e-6, 10.0e-6, 8.0e-6, 10.0e-6, 1.0,
-271.384615e-6, -10.0e-6, -8.0e-6, -10.0e-6, -576.0e-6, -1.0
:SENSe:PVTime:MASK:LIST:UPPer:RELative
1.0, 4.0, 1.0, 1.0, -6.0, -30.0, -59.0,
1.0, 4.0, -6.0, -30.0, -59.0, -59.0
:SENSe:PVTime:MASK:LIST:UPPer:ABSolute
-200.0, -200.0, -200.0, -200.0, -200.0, -17.0, -54.0,
-200.0, -200.0, -200.0, -17.0, -36.0, -54.0
:SENSe:PVTime:MASK:LIST:LOWer:TIME
271.384615e-6, 33.23e-6, 542.76923e-6, 1.0, -271.384615e-6, -1.0
:SENSe:PVTime:MASK:LIST:LOWer:RELative
-1.0, -200.0, -1.0, -200.0, -1.0, -200.0
:SENSe:PVTime:MASK:LIST:LOWer:ABSolute
-200.0, -200.0, -200.0, -200.0, -200.0, -200.0

```

Power vs Time—Select Power Control Level

Allows you to indicate the output power of the transmitter; in MS testing transmitter output power level affects the mask. The appropriate power level for measuring the device under test corresponds to the transmitter power control level setting.

```
[ :SENSe ] :PVTime:PCLevel <integer>
```

```
[ :SENSe ] :PVTime:PCLevel?
```

Range: 0 to 40

Remarks: You must be in the power vs. time measurement in GSM, EDGE mode to use this command. Use INSTRument:SElect to set the mode

Front Panel Access: **Meas Setup, More (1 of 2), Pwr Cntrl Lvl.**

History: E4406A: Added in version A.05.00

Power vs. Time—Sweep Time

```
[ :SENSe ] :PVTime :SWEep :TIME <integer>
```

```
[ :SENSe ] :PVTime :SWEep :TIME?
```

Sets the number of slots that are used in each data acquisition. Each slot is approximately equal to 570 μ s. The measurement is made for a small additional amount of time (about 130 μ s) in order to view the burst edges.

Factory Preset: 1

Range: 1 to 8 (for resolution BW = 500 kHz)

Remarks: For E4406A you must be in the EDGE(w/GSM), GSM or Service mode to use this command. Use INSTRument:SElect to set the mode.

For PSA you must be in the GSM, EDGE mode to use this command. Use INSTRument:SElect to set the mode.

Power vs. Time—Trigger Source

```
[ :SENSe ] :PVTime :TRIGger :SOURce EXTernal [1] | EXTernal2  
| FRAME | IF | IMMEDIATE | RFBURST
```

```
[ :SENSe ] :PVTime :TRIGger :SOURce?
```

Selects the trigger source used to control the data acquisitions.

EXTernal 1 - Front panel external trigger input

EXTernal 2 - Rear panel external trigger input

FRAME - Uses the internal frame timer, which has been synchronized to the selected burst sync.

IF - Internal IF envelope (video) trigger

LINE - Internal power line frequency trigger

IMMEDIATE - The next data acquisition is immediately taken, capturing the signal asynchronously (also called Free Run).

RFBURST - Wideband RF burst envelope trigger that has automatic

level control for periodic burst signals.

Factory Preset: RFBurst if the RF Communications Hardware (option B7E) has been installed

EXTernal, if option B7E has not been installed

FRAMe for 1xEV-DO

IF envelope (video) (iDEN, WiDEN)

Remarks: You must be in GSM, EDGE, Service, 1xEV-DO, iDen, WiDEN, or W-CDMA mode to use this command. Use INSTRUMENT:SElect to set the mode.

Radio Standards Commands

Radio Carrier Hopping

```
[[:SENSe]:RADio:CARRier:HOP OFF|ON|0|1
```

```
[[:SENSe]:RADio:CARRier:HOP?
```

Turns the carrier hopping mode on and off.

Factory Preset: OFF

Remarks: Global to the current mode.

You must be in the GSM, EDGE mode to use this command. Use INSTRument:SElect to set the mode.

History: E4406A: Version A.03.00 or later

Front Panel

Access: **Mode Setup, Radio, Carrier**

Radio Carrier Multiple

```
[[:SENSe]:RADio:CARRier:NUMber SINGLE|MULTiple
```

```
[[:SENSe]:RADio:CARRier:NUMber?
```

Selects whether single or multiple carriers are present on the output of the base station under test. This enables or disables a software filter for the rho and code domain power measurements.

SINGLE – Disable software filter.

MULTiple – Enable software filter to mitigate the adjacent carrier effects.

Factory Preset: SINGLE

Remarks: You must be in the GSM or EDGE, cdmaOne, cdma2000, 1xEV-DO, or iDEN (E4406A) mode to use this command. Use INSTRument:SElect to set the mode.

For GSM/EDGE, this SCPI command setting is available for use with the EDGE EVM measurement or GSM PFER measurement only. Other measurements in the GSM/EDGE personality don't support this feature.

Front Panel

Access: **Mode Setup, Demod, RF Carrier**

Radio Carrier Burst

```
[ :SENSE ] :RADio:CARRier [ :TYPE ] BURSt | CONTinuous
[ :SENSE ] :RADio:CARRier [ :TYPE ] ?
```

Selects the type of RF carrier on the device to be tested.

Factory Preset: BURSt

Remarks: You must be in the GSM, EDGE mode to use this command. Use INSTRument:SElect to set the mode.
Global to the current mode.

History: E4406A: Version A.03.00 or later

Front Panel

Access: **Mode Setup, Radio, Carrier**

Radio Device Under Test

```
[ :SENSE ] :RADio:DEVIce BTS | MS
[ :SENSE ] :RADio:DEVIce?
```

Selects the type of radio device to be tested.

BTS - Base station transmitter test

MS - Mobile station transmitter test

Factory Preset: BTS

Remarks: Global to the current mode.
You must be in cdma2000, GSM, EDGE, W-CDMA or 1xEV-DO mode to use this command. Use INSTRument:SElect to set the mode.

History: E4406A:
Version A.03.00 or later

Front Panel

Access: **Mode Setup, Radio, Device**

BTS Type

```
[ :SENSE ] :RADio:DEVIce:BASE [ :TYPE ]
NORMal | MICRo | MICR1 | MICR2 | MICR3 | PICO
[ :SENSE ] :RADio:DEVIce:BASE [ :TYPE ] ?
```

This parameter is common to all measurements in GSM/EDGE personality.

| | |
|--------------------|---|
| KEY Normal | Normal BTS |
| SCPI NORMal | |
| KEY Micro1 | Micro 1 BTS |
| SCPI MICR1 MICRo | Note: SCPI enumeration 'MICRo' is kept for backward compatibility. It is equivalent to 'MICR1'. |
| KEY Micro2 | Micro 2 BTS |
| SCPI MICR2 | |
| KEY Micro3 | Micro 3 BTS |
| SCPI MICR3 | |
| KEY Pico | Pico BTS |
| SCPI PICO | |
| Mode: | GSM |
| Key Path: | Mode Setup |
| Default: | NORMal |
| State Saved: | Saved in instrument state. |
| Range: | Normal Micro1 Micro2 Micro3 Pico |
| Example: | :SENSe:RADio:DEVice:BASE:TYPE NORMal |

Radio Standard Band

[:SENSe] :RADio:STANdard:BANd
PGSM | EGSM | RGSM | DCS1800 | PCS1900 | GSM450 | GSM480 | GSM700 | GSM850

[:SENSe] :RADio:STANdard:BANd?

Selects the standard variant that applies to the radio to be tested.

PGSM - Primary GSM in the 900 MHz band

EGSM - Extended GSM in the 900 MHz band

RGSM - Railway GSM in the 900 MHz band

DCS1800 - DSC1800 band; also known as GSM-1800

PCS1900 - PCS1900 band; also known as GSM-1900

GSM450 - GSM450 band

GSM480 - GSM480 band

GSM700 - GSM700band

GSM850 - GSM850 band, for IS-136HS

Factory Preset: PGSM for GSM

EGSM-900 for EDGE

Remarks: Global to the current mode.

You must be in GSM, EDGE mode to use this command.
Use INSTRument:SElect to set the mode.

History: E4406A: More standards added A.02.00, A.03.00

Front Panel

Access: **Mode Setup, Radio, Band**

Reference Oscillator Commands

Reference Oscillator External Frequency

```
[[:SENSe]:ROSCillator:EXTErnal:FREQuency <frequency>
```

```
[[:SENSe]:ROSCillator:EXTErnal:FREQuency?
```

Specifies the frequency of the external reference being supplied to the instrument. Switch to the external reference with ROSC:SOUR.

Preset

and *RST: Value remains at last user selected value (persistent)

Factory default, 10 MHz

Range: 1 MHz to 30 MHz, with 1 Hz steps

Default Unit: Hz

Remarks: Global to system.

Front Panel

Access: **System, Reference, Ref Oscillator**

Reference Oscillator Rear Panel Output

```
[[:SENSe]:ROSCillator:OUTPut[:STATe] OFF|ON|0|1
```

```
[[:SENSe]:ROSCillator:OUTPut?
```

Turns on or off the 10 MHz frequency reference signal going to the rear panel.

Preset

and *RST: Persistent State with factory default of On

Remarks: Global to system. Was SENS:ROSC:REAR

Front Panel

Access: **System, Reference, 10 MHz Out**

Reference Oscillator Source

```
[[:SENSe]:ROSCillator:SOURce INTernal|EXTernal
```

```
[[:SENSe]:ROSCillator:SOURce?
```

Selects the reference oscillator (time base) source. Use ROSC:EXT:FREQ to tell the instrument the frequency of the external reference.

INTernal - Uses internally generated 10 MHz reference signal

EXTernal - Uses the signal at the rear panel external reference input port.

Preset
and *RST: Persistent State with factory default of Internal

Remarks: Global to system.

Front Panel
Access: **System, Reference, Ref Oscillator**

Spectrum (Frequency-Domain) Measurement

Commands for querying the spectrum measurement results and for setting to the default values are found in the “MEASure Group of Commands” on page 347. The equivalent front panel keys for the parameters described in the following commands, are found under the **Meas Setup** key, after the **Spectrum (Freq Domain)** measurement has been selected from the **MEASURE** key menu.

Spectrum—Data Acquisition Packing

```
[ :SENSe ] :SPECTrum:ACQuisition:PACKing
```

```
AUTO | LONG | MEdium | SHORt
```

```
[ :SENSe ] :SPECTrum:ACQuisition:PACKing?
```

Selects the amount of data acquisition packing. This is an advanced control that normally does not need to be changed.

Factory Preset: AUTO

Remarks: To use this command for E4406A, the appropriate mode should be selected with **INSTRument:SElect**.

For PSA you must be in the Basic, Analog Modulation, cdmaOne, cdma2000, 1xEV-DO, W-CDMA, GSM, EDGE, NADC, or PDC mode to use this command. Use **INSTRument:SElect** to set the mode.

Spectrum—ADC Dither Control

```
[ :SENSe ] :SPECTrum:ADC:DITHer [ :STATe ] AUTO | ON | OFF | 2 | 1 | 0
```

```
[ :SENSe ] :SPECTrum:ADC:DITHer [ :STATe ] ?
```

Turns the ADC dither on or off. This is an advanced control that normally does not need to be changed. “ADC dither” refers to the introduction of noise to the digitized steps of the analog-to-digital converter; the result is an improvement in amplitude accuracy.

The Option 122 wideband ADC dither uses **SENSe:SPECTrum:WBIF:ADC:DITHer**.

Factory Preset: AUTO

Remarks: To use this command for E4406A, the appropriate mode should be selected with **INSTRument:SElect**.

For PSA you must be in the Basic, Analog Modulation, cdmaOne, cdma2000, 1xEV-DO, W-CDMA, GSM, EDGE, NADC, or PDC mode to use this command. Use **INSTRument:SElect** to set the mode.

Spectrum—ADC Range

12-bit ADC E4406A

`[:SENSE] :SPECTrum:ADC:RANGe`

`AUTO | APEak | APLOCK | M6 | P0 | P6 | P12 | P18 | P24`

PSA and 14-bit ADC E4406A

`[:SENSE] :SPECTrum:ADC:RANGe`

`AUTO | APEak | APLOCK | NONE | P0 | P6 | P12 | P18`

`[:SENSE] :SPECTrum:ADC:RANGe?`

Selects the range for the gain-ranging that is done in front of the ADC. This is an advanced control that normally does not need to be changed. Auto peak ranging is the default for this measurement. If you are measuring a CW signal please see the description below.

AUTO - Automatic range

For FFT spectrums - auto ranging should not be used. An exception to this would be if you know that your signal is “bursty”. Then you might use auto to maximize the time domain dynamic range as long as you are not very interested in the FFT data.

Auto Peak (APEak) - Automatically peak the range

For CW signals, the default of auto-peak ranging can be used, but a better FFT measurement of the signal can be made by selecting one of the manual ranges that are available: M6, P0 - P24.

Auto peaking can cause the ADC range gain to move monotonically down during the data capture. This movement should have negligible effect on the FFT spectrum, but selecting a manual range removes this possibility. Note that if the CW signal being measured is close to the auto-ranging threshold, the noise floor may shift as much as 6 dB from sweep to sweep.

Auto Peak Lock (APLOCK) - Automatically peak lock the range

For CW signals, auto-peak lock ranging may be used. It finds the best ADC measurement range for this particular signal and does not move the range as auto-peak can. Note that if the CW signal being measured is close to the auto-ranging threshold, the noise floor may shift as much as 6 dB from sweep to sweep.

For “bursty” signals, auto-peak lock ranging should not be used. The measurement fails to operate, since the wrong (locked) ADC range is frequently chosen, and overloads occur in the ADC.

NONE (PSA and 14-bit ADC E4406A) - Turns off any auto-ranging without making any changes to the current setting.

M6 (12-bit ADC E4406A) - Manually selects an ADC range that subtracts 6 dB of fixed gain across the range. Manual ranging is best for CW signals.

P0 to P18 (PSA and 14-bit ADC E4406A) - Manually selects ADC ranges that add 0 to 18 dB of fixed gain across the range. Manual ranging is best for CW signals.

P0 to 24 (12-bit ADC E4406A) - Manually selects ADC ranges that add 0 to 24 dB of fixed gain across the range. Manual ranging is best for CW signals.

Factory Preset: APEak

Remarks: To use this command for E4406A, the appropriate mode should be selected with INSTRUMENT:SElect.

For PSA you must be in the Basic, Analog Modulation, cdmaOne, cdma2000, 1xEV-DO, W-CDMA, GSM, EDGE, NADC, or PDC mode to use this command. Use INSTRUMENT:SElect to set the mode.

Spectrum—Average Clear

[[:SENSe] :SPECTrum:AVERage:CLEar

The average data is cleared and the average counter is reset.

Remarks: To use this command for E4406A, the appropriate mode should be selected with INSTRUMENT:SElect.

For PSA you must be in the Basic, Analog Modulation, cdmaOne, cdma2000, 1xEV-DO, W-CDMA, GSM, EDGE, NADC, or PDC mode to use this command. Use INSTRUMENT:SElect to set the mode.

Spectrum—Number of Averages

[[:SENSe] :SPECTrum:AVERage:COUNT <integer>

[[:SENSe] :SPECTrum:AVERage:COUNT?

Sets the number of ‘sweeps’ that are averaged. After the specified number of ‘sweeps’ (average counts), the averaging mode (terminal control) setting determines the averaging action.

Factory Preset: 25

Range: 1 to 10,000

Remarks: To use this command for E4406A, the appropriate mode should be selected with INSTRUMENT:SElect.

For PSA you must be in the Basic, Analog Modulation, cdmaOne, cdma2000, 1xEV-DO, W-CDMA, GSM, EDGE, NADC, or PDC mode to use this command. Use INSTRUMENT:SElect to set the mode.

Spectrum—Averaging State

```
[ :SENSE ] :SPECTrum:AVERAge [ :STATE ] OFF | ON | 0 | 1
```

```
[ :SENSE ] :SPECTrum:AVERAge [ :STATE ] ?
```

Turns averaging on or off.

Factory Preset: On

Remarks: To use this command for E4406A, the appropriate mode should be selected with INSTRUMENT:SELECT.

For PSA you must be in the Basic, Analog Modulation, cdmaOne, cdma2000, 1xEV-DO, W-CDMA, GSM, EDGE, NADC, or PDC mode to use this command. Use INSTRUMENT:SELECT to set the mode.

Spectrum—Averaging Termination Control

```
[ :SENSE ] :SPECTrum:AVERAge:TCONTRol EXPonential | REPeat
```

```
[ :SENSE ] :SPECTrum:AVERAge:TCONTRol ?
```

Selects the type of termination control used for the averaging function. This determines the averaging action after the specified number of ‘sweeps’ (average count) is reached.

EXPonential - Each successive data acquisition after the average count is reached, is exponentially weighted and combined with the existing average.

REPeat - After reaching the average count, the averaging is reset and a new average is started.

Factory Preset: EXPonential

Remarks: To use this command for E4406A, the appropriate mode should be selected with INSTRUMENT:SELECT.

For PSA you must be in the Basic, Analog Modulation, cdmaOne, cdma2000, 1xEV-DO, W-CDMA, GSM, EDGE, NADC, or PDC mode to use this command. Use INSTRUMENT:SELECT to set the mode.

Spectrum—Averaging Type

```
[ :SENSE ] :SPECTrum:AVERAge:TYPE
```

```
LOG | MAXimum | MINimum | RMS | SCALar
```

```
[ :SENSE ] :SPECTrum:AVERAge:TYPE?
```

Selects the type of averaging.

LOG – The log of the power is averaged. (This is also known as video averaging.)

MAXimum – The maximum values are retained.

MINimum – The minimum values are retained.

RMS – The power is averaged, providing the rms of the voltage.

SCALar – The voltage is averaged.

Factory Preset: LOG

Remarks: To use this command for E4406A, the appropriate mode should be selected with INSTRUMENT:SElect.

For PSA you must be in the Basic, Analog Modulation, cdmaOne, cdma2000, 1xEV-DO, W-CDMA, GSM, EDGE, NADC, or PDC mode to use this command. Use INSTRUMENT:SElect to set the mode.

Spectrum—Select Pre-FFT Bandwidth

```
[[:SENSe]:SPECTrum:BANDwidth|BWIDth:IF:AUTO OFF|ON|0|1
```

```
[[:SENSe]:SPECTrum:BANDwidth|BWIDth:IF:AUTO?
```

Selects auto or manual control of the pre-FFT BW.

Factory Preset: Auto, 1.55 MHz

Auto, 10 MHz for wideband IF path
(SENSe:SPECTrum:IFPath WIDE)

Couplings/

Dependencies: PSA: If you have the wideband Option 122 and the wideband IF path is selected, then the sample rate = $1.25 \times$ IF bandwidth.

Remarks: To use this command for E4406A, the appropriate mode should be selected with INSTRUMENT:SElect.

For PSA you must be in the Basic, Analog Modulation, cdmaOne, cdma2000, 1xEV-DO, W-CDMA, GSM, EDGE, NADC, or PDC mode to use this command. Use INSTRUMENT:SElect to set the mode.

Front Panel

Access: **Measure, Spectrum, Meas Setup, More, Advanced, Pre-FFT BW.**

History: Modified in PSA revision A.06.00.

Spectrum—IF Flatness Corrections

```
[ :SENSE ] :SPECTrum: BANDwidth | BWIDth: IF: FLATness OFF | ON | 0 | 1
[ :SENSE ] :SPECTrum: BANDwidth | BWIDth: IF: FLATness ?
```

Turns IF flatness corrections on and off for the pre-FFT narrowband IF. The Option 122 wideband IF flatness control uses SENSE:SPECTrum:WBIF:FLATness.

Factory Preset: ON

Remarks: To use this command for E4406A, the appropriate mode should be selected with INSTRUMENT:SELEct.

For PSA you must be in the Basic, Analog Modulation, cdmaOne, cdma2000, 1xEV-DO, W-CDMA, GSM, EDGE, NADC, or PDC mode to use this command. Use INSTRUMENT:SELEct to set the mode.

Front Panel

Access: **Measure, Spectrum, Meas Setup, More, Advanced, Pre-FFT BW**

Spectrum—Pre-ADC Bandpass Filter

```
[ :SENSE ] :SPECTrum: BANDwidth | BWIDth: PADC OFF | ON | 0 | 1
[ :SENSE ] :SPECTrum: BANDwidth | BWIDth: PADC ?
```

Turns the pre-ADC bandpass filter on or off. This is an advanced control that normally does not need to be changed.

Remarks: To use this command for E4406A, the appropriate mode should be selected with INSTRUMENT:SELEct.

For PSA you must be in the Basic, Analog Modulation, cdmaOne, cdma2000, 1xEV-DO, W-CDMA, GSM, EDGE, NADC, or PDC mode to use this command. Use INSTRUMENT:SELEct to set the mode.

Spectrum—Pre-FFT BW

```
[ :SENSE ] :SPECTrum: BANDwidth | BWIDth: PFFT [ :SIZE ] <freq>
[ :SENSE ] :SPECTrum: BANDwidth | BWIDth: PFFT [ :SIZE ] ?
```

Sets the pre-FFT bandwidth. This is an advanced control that normally does not need to be changed.

Frequency span, resolution bandwidth, and the pre-FFT bandwidth settings are normally coupled. If the function is not auto-coupled, certain combinations of these settings are not valid.

Factory Preset: 1.55 MHz

1.25 MHz for cdmaOne

155.0 kHz, for iDEN mode (E4406A)

Range: 1 Hz to 10.0 MHz

Remarks: To use this command for E4406A, the appropriate mode should be selected with INSTRUMENT:SElect.

For PSA you must be in the Basic, Analog Modulation, cdmaOne, cdma2000, 1xEV-DO, W-CDMA, GSM, EDGE, NADC, or PDC mode to use this command. Use INSTRUMENT:SElect to set the mode.

Spectrum—Pre-FFT BW Filter Type

```
[ :SENSe ] :SPEctrum:BA NDwidth | BWIDth:PF FT:TYPE FLAT | GAUSSian
```

```
[ :SENSe ] :SPEctrum:BA NDwidth | BWIDth:PF FT:TYPE?
```

Selects the type of pre-FFT filter that is used. This is an advanced control that normally does not need to be changed.

Flat top (FLAT)- A filter with a flat amplitude response, which provides the best amplitude accuracy.

GAUSSian - A filter with Gaussian characteristics, which provides the best pulse response.

Factory Preset: FLAT

Couplings/

Dependencies: From the front panel this functionality is not available (key is grayed out), but this command changes the setting.

Remarks: To use this command for E4406A, the appropriate mode should be selected with INSTRUMENT:SElect.

For PSA you must be in the Basic, Analog Modulation, cdmaOne, cdma2000, 1xEV-DO, W-CDMA, GSM, EDGE, NADC, or PDC mode to use this command. Use INSTRUMENT:SElect to set the mode.

History: PSA: modified with revision A.06.00

Spectrum—Resolution BW

```
[ :SENSe ] :SPEctrum:BA NDwidth | BWIDth [ :RESolution ] <freq>
```

```
[ :SENSe ] :SPEctrum:BA NDwidth | BWIDth [ :RESolution ] ?
```

Sets the resolution bandwidth for the FFT. This is the bandwidth used for resolving the FFT measurement. It is not the pre-FFT bandwidth. This value is ignored if the function is auto-coupled.

Frequency span, resolution bandwidth, and the pre-FFT bandwidth settings are normally coupled. If the function is not auto-coupled, certain combinations of these settings are not valid.

Factory Preset: 20.0 kHz

250.0 Hz, for iDEN mode (E4406A)

Range: 0.10 Hz to 3.0 MHz

Remarks: To use this command for E4406A, the appropriate mode should be selected with INSTRUMENT:SELECT.

For PSA you must be in the Basic, Analog Modulation, cdmaOne, cdma2000, 1xEV-DO, W-CDMA, GSM, EDGE, NADC, or PDC mode to use this command. Use INSTRUMENT:SELEct to set the mode.

Spectrum—Resolution BW Auto

```
[ :SENSE ] :SPECTrum: BANDwidth | BWIDth [ :RESolution ] :AUTO  
OFF | ON | 0 | 1
```

```
[ :SENSE ] :SPECTrum: BANDwidth | BWIDth [ :RESolution ] :AUTO?
```

Selects auto or manual control of the resolution BW. The automatic mode couples the resolution bandwidth setting to the frequency span.

Factory Preset: ON

OFF, for iDEN mode (E4406A)

Remarks: To use this command for E4406A, the appropriate mode should be selected with INSTRUMENT:SELECT.

For PSA you must be in the Basic, Analog Modulation, cdmaOne, cdma2000, W-CDMA, GSM, EDGE, NADC, or PDC mode to use this command. Use INSTRUMENT:SELEct to set the mode.

Spectrum—Decimation of Spectrum Display

```
[ :SENSE ] :SPECTrum: DECimate [ :FACTor ] <integer>
```

```
[ :SENSE ] :SPECTrum: DECimate [ :FACTor ] ?
```

Sets the amount of data decimation done by the hardware and/or the software. Decimation by n keeps every nth sample, throwing away each of the remaining samples in each group of n. For example, decimation

by 3 keeps every third sample, throwing away the two in between. Similarly, decimation by 5 keeps every fifth sample, throwing away the four in between.

Using zero (0) decimation selects the automatic mode. The measurement then automatically chooses decimation by “1” or “2” as is appropriate for the bandwidth being used.

This is an advanced control that normally does not need to be changed.

Factory Preset: 0

Range: 0 to 1,000, where 0 sets the function to automatic

Remarks: To use this command for E4406A, the appropriate mode should be selected with INSTRUMENT:SElect.

For PSA you must be in the Basic, Analog Modulation, cdmaOne, cdma2000, 1xEV-DO, W-CDMA, GSM, EDGE, NADC, or PDC mode to use this command. Use INSTRUMENT:SElect to set the mode.

History: E4406A:
Version A.02.00 or later

Spectrum—FFT Length

[:SENSe] :SPECTrum:FFT:LENGth <integer>

[:SENSe] :SPECTrum:FFT:LENGth?

Sets the FFT length. This value is only used if length control is set to manual. The value must be greater than or equal to the window length value. Any amount greater than the window length is implemented by zero-padding. This is an advanced control that normally does not need to be changed.

Factory Preset: 706

Range: Min - Depends on the current setting of the spectrum window length

Max - 1,048,576

Remarks: To use this command for E4406A, the appropriate mode should be selected with INSTRUMENT:SElect.

For PSA you must be in the Basic, Analog Modulation, cdmaOne, cdma2000, 1xEV-DO, W-CDMA, GSM, EDGE, NADC, or PDC mode to use this command. Use INSTRUMENT:SElect to set the mode.

History: E4406A:
Short form changed from LENGth to LENGth, A.03.00

Spectrum—FFT Length Auto

`[:SENSE] :SPECTrum:FFT:LENGth:AUTO OFF | ON | 0 | 1`

`[:SENSE] :SPECTrum:FFT:LENGth:AUTO?`

Selects auto or manual control of the FFT and window lengths.

This is an advanced control that normally does not need to be changed.

On - The window lengths are coupled to resolution bandwidth, window type (FFT), pre-FFT bandwidth (sample rate) and `SENSE:SPECTrum:FFT:RBWPoints`.

Off - Lets you set `SENSE:SPECTrum:FFT:LENGth` and `SENSE:SPECTrum:FFT:WINDow:LENGth`.

Factory Preset: ON

Remarks: To use this command for E4406A, the appropriate mode should be selected with `INSTrument:SElect`.

For PSA you must be in the Basic, Analog Modulation, cdmaOne, cdma2000, 1xEV-DO, W-CDMA, GSM, EDGE, NADC, or PDC mode to use this command. Use `INSTrument:SElect` to set the mode.

History: E4406A:
Short form changed from `LENGth` to `LENGth`, A.03.00

Spectrum—FFT Minimum Points in Resolution BW

`[:SENSE] :SPECTrum:FFT:RBWPoints <real>`

`[:SENSE] :SPECTrum:FFT:RBWPoints?`

Sets the minimum number of data points that are used inside the resolution bandwidth. The value is ignored if length control is set to manual. This is an advanced control that normally does not need to be changed.

Factory Preset: 1.30

Range: 0.1 to 100

Remarks: To use this command for E4406A, the appropriate mode should be selected with `INSTrument:SElect`.

For PSA you must be in the Basic, Analog Modulation, cdmaOne, cdma2000, 1xEV-DO, W-CDMA, GSM, EDGE, NADC, or PDC mode to use this command. Use `INSTrument:SElect` to set the mode.

Spectrum—Window Delay

```
[ :SENSe ] :SPEctrum:FFT:WINDow:DELay <real>
```

```
[ :SENSe ] :SPEctrum:FFT:WINDow:DELay?
```

Sets the FFT window delay to move the FFT window from its nominal position of being centered within the time capture. This function is not available from the front panel. It is an advanced control that normally does not need to be changed.

Factory Preset: 0

Range: -10.0 to +10.0s

Default Unit: seconds

Remarks: To use this command for E4406A, the appropriate mode should be selected with INSTRUMENT:SElect.

For PSA you must be in the Basic, Analog Modulation, cdmaOne, cdma2000, 1xEV-DO, W-CDMA, GSM, EDGE, NADC, or PDC mode to use this command. Use INSTRUMENT:SElect to set the mode.

Spectrum—Window Length

```
[ :SENSe ] :SPEctrum:FFT:WINDow:LENGth <integer>
```

```
[ :SENSe ] :SPEctrum:FFT:WINDow:LENGth?
```

Sets the FFT window length. This value is only used if length control is set to manual. This is an advanced control that normally does not need to be changed.

Factory Preset: 706

Range: 8 to 1,048,576

Remarks: To use this command for E4406A, the appropriate mode should be selected with INSTRUMENT:SElect.

For PSA you must be in the Basic, Analog Modulation, cdmaOne, cdma2000, 1xEV-DO, W-CDMA, GSM, EDGE, NADC, or PDC mode to use this command. Use INSTRUMENT:SElect to set the mode.

History: E4406A:
Short form changed from LENGth to LENGth, A.03.00

Spectrum—FFT Window

```
[ :SENSe ] :SPEctrum:FFT:WINDow [ :TYPE ]
```

```
BH4Tap | BLACkman | FLATtop | GAUSSian | HAMMING | HANNing | KB70 | KB90 |
```

KB110 | UNIFORM

[:SENSE] :SPECTrum:FFT:WINDow [:TYPE] ?

Selects the FFT window type.

BH4Tap - Blackman Harris with 4 taps

BLACkman - Blackman

FLATtop - Flat top, the default (for high amplitude accuracy)

GAUSSian - Gaussian with alpha of 3.5

HAMMING - Hamming

HANNing - Hanning

KB70, 90, and 110 - Kaiser Bessel with sidelobes at -70, -90, or -110 dBc

UNIFORM - No window is used. (This is the unity response.)

Factory Preset: FLATtop

Remarks: This selection affects the acquisition point quantity and the FFT size, based on the resolution bandwidth selected.

To use this command for E4406A, the appropriate mode should be selected with INSTRUMENT:SElect.

For PSA you must be in the Basic, Analog Modulation, cdmaOne, cdma2000, 1xEV-DO, W-CDMA, GSM, EDGE, NADC, or PDC mode to use this command. Use INSTRUMENT:SElect to set the mode.

Spectrum—Frequency Span

[:SENSe] :SPECTrum:FREQUency:SPAN <freq>

[:SENSe] :SPECTrum:FREQUency:SPAN?

Sets the frequency span to be measured.

Factory Preset: 1.0 MHz

100.0 kHz for iDEN mode (E4406A)

Range: 10 Hz to 10.0 MHz (15 MHz when Service mode is selected)

Default Unit: Hz

Remarks: The actual measured span is generally slightly wider due to the finite resolution of the FFT.

To use this command for E4406A, the appropriate mode

should be selected with INSTRument:SElect.

For PSA you must be in the Basic, Analog Modulation, cdmaOne, cdma2000, 1xEV-DO, W-CDMA, GSM, EDGE, NADC, or PDC mode to use this command. Use INSTRument:SElect to set the mode.

Spectrum—Sweep (Acquisition) Time

```
[ :SENSe ] :SPECTrum:SWEep:TIME [ :VALue ] <time>
```

```
[ :SENSe ] :SPECTrum:SWEep:TIME?
```

Sets the sweep (measurement acquisition) time. It is used to specify the length of the time capture record. If the value you specify is less than the capture time required for the specified span and resolution bandwidth, the value is ignored. The value is set at its auto value when auto is selected. This is an advanced control that normally does not need to be changed.

Factory Preset: 18.83 μ s

15.059 ms, for iDEN mode (E4406A)

Range: 100 ns to 10 s

Default Unit: seconds

Remarks: To use this command for E4406A, the appropriate mode should be selected with INSTRument:SElect.

For PSA you must be in the Basic, Analog Modulation, cdmaOne, cdma2000, 1xEV-DO, W-CDMA, GSM, EDGE, NADC, or PDC mode to use this command. Use INSTRument:SElect to set the mode.

Spectrum—Sweep (Acquisition) Time Auto

```
[ :SENSe ] :SPECTrum:SWEep:TIME:AUTO OFF | ON | 0 | 1
```

```
[ :SENSe ] :SPECTrum:SWEep:TIME:AUTO
```

Selects auto or manual control of the sweep (acquisition) time. This is an advanced control that normally does not need to be changed.

AUTO - Couples the Sweep Time to the Frequency Span and Resolution BW

Manual - The Sweep Time is uncoupled from the Frequency Span and Resolution BW.

Factory Preset: AUTO

Remarks: To use this command for E4406A, the appropriate mode

should be selected with INSTRUMENT:SElect.

For PSA you must be in the Basic, Analog Modulation, cdmaOne, cdma2000, 1xEV-DO, W-CDMA, GSM, EDGE, NADC, or PDC mode to use this command. Use INSTRUMENT:SElect to set the mode.

Spectrum—Trigger Source

```
[ :SENSE ] :SPECTrum:TRIGger:SOURce
EXTernal [1] | EXTernal2 | FRAME | IF | LINE | IMMEDIATE
| RFBurst
```

```
[ :SENSE ] :SPECTrum:TRIGger:SOURce?
```

Selects the trigger source used to control the data acquisitions.

EXTernal1 - Front panel external trigger input

EXTernal2 - Rear panel external trigger input

FRAME - Internal frame timer from front panel input

IF - Internal IF envelope (video) trigger

LINE - Internal line trigger

IMMEDIATE - The next data acquisition is immediately taken (also called free run)

RFBurst - Wideband RF burst envelope trigger that has automatic level control for periodic burst signals

Factory Preset: IMMEDIATE (free run)

RFBurst, for GSM, iDEN mode

Remarks: To use this command for E4406A, the appropriate mode should be selected with INSTRUMENT:SElect.

For PSA you must be in the Basic, Analog Modulation, cdmaOne, cdma2000, 1xEV-DO, W-CDMA, GSM, EDGE, NADC, or PDC mode to use this command. Use INSTRUMENT:SElect to set the mode.

Synchronization Commands

Sync Alignment

```
[ :SENSe ] :SYNC:ALIGnment GSM|HBIT
```

```
[ :SENSe ] :SYNC:ALIGnment?
```

Selects the sync alignment to be either to the GSM standard or the standard offset by 1/2 bit.

GSM - Burst alignment as defined in the GSM standard

HBIT - Burst alignment is advanced by 1/2 bit, which corresponds to an earlier interpretation of the GSM standard

Factory Preset: HBIT

Remarks: Global to the current mode.

You must be in the GSM, EDGE mode to use this command. Use INSTRument:SElect to set the mode.

Front Panel

Access: **Mode Setup, Demod, Burst Align**

Sync Burst RF Amplitude Delay

```
[ :SENSe ] :SYNC:BURSt:RFAMplitude:DELay <time>
```

```
[ :SENSe ] :SYNC:BURSt:RFAMplitude:DELay?
```

Sets the delay for the RF amplitude sync.

Factory Preset: 0 s

Range: -100 ms to 100 ms

Default Unit: seconds

Remarks: Global to the current mode.

You must be in the GSM, EDGE mode to use this command. Use INSTRument:SElect to set the mode.

Front Panel

Access: **Mode Setup, Trigger, RF Sync Delay**

Burst Search Threshold

```
[ :SENSe ] :SYNC:BURSt:STHreshold <rel_power>
```

```
[ :SENSe ] :SYNC:BURSt:STHreshold?
```

Sets the relative power threshold, which is used to determine the

timeslots that are included in the search for GSM bursts. For measurements that have burst sync set to training sequence, these bursts are the only ones that will be searched for valid TSCs (training sequence codes). The threshold power is relative to the peak power of the highest power timeslot. This is useful when you are measuring a BTS with different power levels in different timeslots, and you want to exclude bursts with lower power levels.

Factory Preset: -10 dB

Range: -200 to -0.01 dB

Default Unit: dB

Remarks: You must be in the GSM, EDGE mode to use this command. Use INSTRUMENT:SElect to set the mode.

Front Panel

Access: **Mode Setup, Trigger, Slot Threshold**

GMSK Transmit Band Spurs Measurement

Commands for querying the transmit band spurs measurement results and for setting to the default values are found in the [“MEASure Group of Commands” on page 347](#). The equivalent front panel keys for the parameters described in the following commands, are found under the **Meas Setup** key, after the **GMSK TxBand Spur** measurement has been selected from the **MEASURE** key menu.

Transmit Band Spurs—Average Count

```
[ :SENSe ] : TSPur : AVERAge : COUNT <integer>
```

```
[ :SENSe ] : TSPur : AVERAge : COUNT ?
```

Sets the number of data acquisitions that are averaged. After the specified number of average counts, the averaging termination setting determines the averaging action.

Factory Preset: 15

Range: 1 to 10,000

Remarks: You must be in the GSM, EDGE mode to use this command. Use INSTRUMENT:SElect to set the mode.

History: E4406A:
Version A.03.00 or later

Transmit Band Spurs—Averaging State

```
[ :SENSe ] : TSPur : AVERAge [ :STATE ] OFF | ON | 0 | 1
```

`[:SENSe] :TSPur :AVERAge [:STATe] ?`

Turns averaging on or off.

Factory Preset: ON

Remarks: You must be in the GSM, EDGE mode to use this command. Use INSTRument:SElect to set the mode.

History: E4406A:
Version A.03.00 or later

Transmit Band Spurs—Averaging Termination Control

`[:SENSe] :TSPur :AVERAge :TCONtrol EXPonential | REPeat`

`[:SENSe] :TSPur :AVERAge :TCONtrol ?`

Selects the type of termination control used for the averaging function. This determines the averaging action after the specified number of data acquisitions (average count) is reached.

EXPonential - After the average count has been reached, each successive data acquisition is exponentially weighted and combined with the existing average.

REPeat - After reaching the average count, the averaging is reset and a new average is started.

Factory Preset: REPeat

Remarks: You must be in the GSM, EDGE mode to use this command. Use INSTRument:SElect to set the mode.

History: E4406A:
Version A.03.00 or later

Transmit Band Spurs—Averaging Type

`[:SENSe] :TSPur :AVERAge :TYPE LOG | MAXimum | RMS`

`[:SENSe] :TSPur :AVERAge :TYPE ?`

Selects the type of averaging.

LOG - The log of the power is averaged. (This is also known as video averaging.)

MAXimum - The maximum values are retained.

RMS - The power is averaged, providing the rms of the voltage.

Factory Preset: MAXimum

Remarks: You must be in the GSM, EDGE mode to use this

command. Use INSTRument:SElect to set the mode.

History: E4406A:
Version A.03.00 or later

Transmit Band Spurs—Type

[:SENSE] :TSPur:TYPE EXAMine | FULL

[:SENSE] :TSPur:TYPE?

Selects the measurement type.

EXAMine - Measures spurs in all the valid segments and then displays the segment that has the worst spur

FULL - Continuously measures the spurs in all the valid segments

Factory Preset: FULL

Remarks: You must be in the GSM, EDGE mode to use this command. Use INSTRument:SElect to set the mode.

History: E4406A:
Version A.03.00 or later

Transmit Power Measurement

Commands for querying the transmit power measurement results and for setting to the default values are found in the “MEASure Group of Commands” on page 347. The equivalent front panel keys for the parameters described in the following commands, are found under the **Meas Setup** key, after the **Transmit Power** measurement has been selected from the **MEASURE** key menu.

Transmit Power—Number of Bursts Averaged

```
[ :SENSe ] :TXPower:AVERAge:COUNT <integer>
```

```
[ :SENSe ] :TXPower:AVERAge:COUNT?
```

Sets the number of bursts that are averaged. After the specified number of bursts (average counts), the averaging mode (termination control) setting determines the averaging action.

Factory Preset: 50

Range: 1 to 10,000

Remarks: You must be in the GSM, EDGE mode to use this command. Use INSTRument:SElect to set the mode.

Transmit Power—Averaging State

```
[ :SENSe ] :TXPower:AVERAge [ :STATe ] OFF | ON | 0 | 1
```

```
[ :SENSe ] :TXPower:AVERAge [ :STATe ] ?
```

Turns averaging on or off.

Factory Preset: ON

Remarks: You must be in the GSM, EDGE mode to use this command. Use INSTRument:SElect to set the mode.

Transmit Power—Averaging Termination Control

```
[ :SENSe ] :TXPower:AVERAge:TCONTRol EXPonential | REPeat
```

```
[ :SENSe ] :TXPower:AVERAge:TCONTRol?
```

Selects the type of termination control used for the averaging function. This determines the averaging action after the specified number of frames (average count) is reached.

EXPonential - After the average count has been reached, each successive data acquisition is exponentially weighted and combined with the existing average.

REPeat - After reaching the average count, the averaging is reset

and a new average is started.

Factory Preset: EXPOnential

Remarks: You must be in the GSM, EDGE mode to use this command. Use INSTRument:SElect to set the mode.

Transmit Power—Averaging Type

```
[ :SENSe ] :TXPower :AVERAge :TYPE | LOG | MAX | MIN | RMS
```

```
[ :SENSe ] :TXPower :AVERAge :TYPE?
```

Selects the type of averaging to be performed.

- LOG - The log of the power is averaged. (This is also known as video averaging.)
- MAXimum - The maximum values are retained.
- MINimum - The minimum values are retained.
- RMS - The power is averaged, providing the rms of the voltage.

Factory Preset: RMS

Remarks: You must be in the GSM, EDGE mode to use this command. Use INSTRument:SElect to set the mode.

Transmit Power—Resolution BW

```
[ :SENSe ] :TXPower :BANDwidth | BWIDth [ :RESolution ] <freq>
```

```
[ :SENSe ] :TXPower :BANDwidth | BWIDth [ :RESolution ] ?
```

Sets the resolution BW. This is an advanced control that normally does not need to be changed. Setting it to a value other than the factory default may cause invalid measurement results.

Factory Preset: 500 kHz

Range: 1 kHz to 5 MHz

Default Unit: Hz

Remarks: You must be in the GSM, EDGE mode to use this command. Use INSTRument:SElect to set the mode.

Transmit Power—Resolution BW Filter Type

```
[ :SENSe ] :TXPower :BANDwidth | BWIDth [ :RESolution ] :TYPE  
FLAT | GAUSSian
```

```
[ :SENSe ] :TXPower :BANDwidth | BWIDth [ :RESolution ] :TYPE?
```

Selects the type of resolution BW filter. This is an advanced control that normally does not need to be changed. Setting this to a value other than the factory default may cause invalid measurement results.

Flat top (FLAT) - A filter with a flat amplitude response, which provides the best amplitude accuracy.

GAUSSian - A filter with Gaussian characteristics, which provides the best pulse response.

Factory Preset: GAUSSian

Remarks: You must be in the GSM, EDGE mode to use this command. Use INSTRument:SElect to set the mode.

Transmit Power—Sweep Time

```
[ :SENSe ] :TXPower :SWEep :TIME <integer>
```

```
[ :SENSe ] :TXPower :SWEep :TIME?
```

Sets the number of slots which are used in each data acquisition. Each slot is approximately equal to 600 ms.

Factory Preset: 1

Range: 1 to 50 time slots (for resolution BW = 500 kHz)

Remarks: You must be in the GSM, EDGE or Service mode to use this command. Use INSTRument:SElect to set the mode.

Transmit Power—Threshold Level

```
[ :SENSe ] :TXPower :THReshold <power>
```

```
[ :SENSe ] :TXPower :THReshold?
```

Sets the amplitude threshold level. Only the data above the threshold level is kept and used to compute the average transmit carrier power.

Factory Preset: -6.0 dB

Range: -100 dB to 0 dB, for relative mode
-100 dBm to +30 dB, for absolute mode

Default Unit: dB for relative mode
dBm for absolute mode

Remarks: The command (SENSe:TXPower:THReshold:TYPE ABSolute | RELative) determines whether this command is setting an absolute or a relative power level.

You must be in the GSM, EDGE mode to use this command. Use INSTRUMENT:SELEct to set the mode.

Transmit Power—Threshold Type

`[:SENSE] :TXPower:THReshold:TYPE ABSolute | RELative`

`[:SENSe] :TXPower:THReshold:TYPE?`

Selects auto or manual control of the threshold level.

ABSolute - Threshold value is set to an absolute power level

RELative - Threshold value is set relative to the reference

Factory Preset: RELative

Remarks: You must be in the GSM, EDGE mode to use this command. Use INSTRUMENT:SELEct to set the mode.

Transmit Power—Trigger Source

`[:SENSe] :TXPower:TRIGger:SOURce`

`EXTErnal [1] | EXTErnal2 | IF | IMMEDIATE | RFBurst`

`[:SENSe] :TXPower:TRIGger:SOURce?`

Selects the trigger source used to control the data acquisitions.

EXTErnal 1 - Front panel external trigger input

EXTErnal 2 - Rear panel external trigger input

IF - Internal IF envelope (video) trigger

IMMEDIATE - The next data acquisition is immediately taken (also called free run)

RFBurst - Wideband RF burst envelope trigger that has automatic level control for periodic burst signals.

Factory Preset: RFBurst

Remarks: You must be in the GSM, EDGE mode to use this command. Use INSTRUMENT:SELEct to set the mode.

Waveform (Time-Domain) Measurement

Commands for querying the waveform measurement results and for setting to the default values are found in the “MEASure Group of Commands” on page 347. The equivalent front panel keys for the parameters described in the following commands, are found under the **Meas Setup** key, after the **Waveform (Time Domain)** measurement has been selected from the **MEASURE** key menu.

Waveform—Data Acquisition Packing

```
[ :SENSe ] :WAVeform:ACQuisition:PACKing  
AUTO | LONG | MEDium | SHORt
```

```
[ :SENSe ] :WAVeform:ACQuisition:PACKing?
```

This is an advanced control that normally does not need to be changed.

Factory Preset: AUTO

Remarks: To use this command for E4406A, the appropriate mode should be selected with INSTRument:SElect.

For PSA you must be in the Basic, Analog Modulation, cdmaOne, cdma2000, 1xEV-DO, W-CDMA, GSM, EDGE, NADC, or PDC mode to use this command. Use INSTRument:SElect to set the mode.

Waveform—ADC Dither Control

```
[ :SENSe ] :WAVeform:ADC:DITHer [ :STATe ] AUTO | ON | OFF | 2 | 1 | 0
```

```
[ :SENSe ] :WAVeform:ADC:DITHer [ :STATe ] ?
```

Turns the ADC dither on or off. This is an advanced control that normally does not need to be changed. “ADC dither” refers to the introduction of noise to the digitized steps of the analog-to-digital converter; the result is an improvement in amplitude accuracy.

The Option 122 wideband ADC dither uses
SENSe:WAVeform:WBIF:ADC:DITHer.

Factory Preset: AUTO

Remarks: To use this command for E4406A, the appropriate mode should be selected with INSTRument:SElect.

For PSA you must be in the Basic, Analog Modulation, cdmaOne, cdma2000, 1xEV-DO, W-CDMA, GSM, EDGE, NADC, or PDC mode to use this command. Use INSTRument:SElect to set the mode.

Waveform—Pre-ADC Bandpass Filter

`[:SENSE] :WAVEform:ADC:FILTer [:STATe] OFF | ON | 0 | 1`

`[:SENSe] :WAVEform:ADC:FILTer [:STATe] ?`

Turns the pre-ADC bandpass filter on or off. This is an Advanced control that normally does not need to be changed.

Preset: OFF

Remarks: To use this command for E4406A, the appropriate mode should be selected with `INSTRument:SELEct`.

For PSA you must be in the Basic, Analog Modulation, cdmaOne, cdma2000, 1xEV-DO, W-CDMA, GSM, EDGE, NADC, or PDC mode to use this command. Use `INSTRument:SELEct` to set the mode.

Waveform—ADC Range

12-bit ADC E4406A

`[:SENSE] :WAVEform:ADC:RANGe`

`AUTO | APEak | APLOCK | GROund | M6 | P0 | P6 | P12 | P18 | P24`

PSA and 14-bit ADC E4406A

`[:SENSE] :WAVEform:ADC:RANGe`

`AUTO | APEak | APLOCK | GROund | NONE | P0 | P6 | P12 | P18`

`[:SENSe] :WAVEform:ADC:RANGe?`

Selects the range for the gain-ranging that is done in front of the ADC. This is an Advanced control that normally does not need to be changed.

AUTO - Automatic range

Auto Peak (APEak) - Automatically peak the range

Auto Peak Lock (APLOCK)- Automatically peak lock the range

GROund - Ground

NONE (PSA and 14-bit ADC E4406A) - Turn off auto-ranging without making any changes to the current setting.

M6 (12-bit ADC E4406A) - Subtracts 6 dB of fixed gain across the range

P0 to P18 (PSA and 14-bit ADC E4406A) - Adds 0 to 18 dB of fixed gain across the range

P0 to P24 (12-bit ADC E4406A) - Adds 0 to 24 dB of fixed gain across the range

Factory Preset: AUTO

Remarks: To use this command for E4406A, the appropriate mode should be selected with INSTRUMENT:SElect.

For PSA you must be in the Basic, Analog Modulation, cdmaOne, cdma2000, 1xEV-DO, W-CDMA, GSM, EDGE, NADC, or PDC mode to use this command. Use INSTRUMENT:SElect to set the mode.

Waveform—Sample Period (Aperture) Setting

[:SENSe] :WAVeform:APERture?

Returns the time between samples (sample period or aperture). This value is based on current resolution bandwidth, filter type, and decimation factor. Sample rate is the reciprocal of the period.

Remarks: To use this command for E4406A, the appropriate mode should be selected with INSTRUMENT:SElect.

For PSA you must be in the Basic, Analog Modulation, cdmaOne, cdma2000, 1xEV-DO, W-CDMA, GSM, EDGE, NADC, or PDC mode to use this command. Use INSTRUMENT:SElect to set the mode.

History: PSA added revision A.04.00.

Waveform—Number of Averages

[:SENSe] :WAVeform:AVERAge:COUNT <integer>

[:SENSe] :WAVeform:AVERAge:COUNT?

Sets the number of sweeps that are averaged. After the specified number of sweeps (average counts), the averaging mode (terminal control) setting determines the averaging action.

Factory Preset: 10

Range: 1 to 10,000

Remarks: To use this command for E4406A, the appropriate mode should be selected with INSTRUMENT:SElect.

For PSA you must be in the Basic, Analog Modulation, cdmaOne, cdma2000, 1xEV-DO, W-CDMA, GSM, EDGE, NADC, or PDC mode to use this command. Use INSTRUMENT:SElect to set the mode.

Waveform—Averaging State

[:SENSe] :WAVeform:AVERAge [:STATe] OFF | ON | 0 | 1

[:SENSE] :WAVEform:AVERage [:STATe] ?

Turns averaging on or off.

Factory Preset: OFF

Remarks: To use this command for E4406A, the appropriate mode should be selected with INSTRUMENT:SELECT.

For PSA you must be in the Basic, Analog Modulation, cdmaOne, cdma2000, 1xEV-DO, W-CDMA, GSM, EDGE, NADC, or PDC mode to use this command. Use INSTRUMENT:SELECT to set the mode.

Waveform—Averaging Termination Control

[:SENSE] :WAVEform:AVERage:TCONtrol EXPonential | REPeat

[:SENSE] :WAVEform:AVERage:TCONtrol?

Selects the type of termination control used for the averaging function. This determines the averaging action after the specified number of ‘sweeps’ (average count) is reached.

EXPonential - After the average count has been reached, each successive data acquisition is exponentially weighted and combined with the existing average.

REPeat - After reaching the average count, the averaging is reset and a new average is started.

Factory Preset: EXPonential

Remarks: To use this command for E4406A, the appropriate mode should be selected with INSTRUMENT:SELECT.

For PSA you must be in the Basic, Analog Modulation, cdmaOne, cdma2000, 1xEV-DO, W-CDMA, GSM, EDGE, NADC, or PDC mode to use this command. Use INSTRUMENT:SELECT to set the mode.

Waveform—Averaging Type

**[:SENSE] :WAVEform:AVERage:TYPE
LOG | MAXimum | MINimum | RMS | SCALar**

[:SENSE] :WAVEform:AVERage:TYPE?

Selects the type of averaging.

LOG - The log of the power is averaged. (This is also known as video averaging.)

MAXimum - The maximum values are retained.

MINimum - The minimum values are retained.

RMS - The power is averaged, providing the rms of the voltage.

Factory Preset: RMS

Remarks: To use this command for E4406A, the appropriate mode should be selected with INSTRUMENT:SElect.

For PSA you must be in the Basic, Analog Modulation, cdmaOne, cdma2000, 1xEV-DO, W-CDMA, GSM, EDGE, NADC, or PDC mode to use this command. Use INSTRUMENT:SElect to set the mode.

Waveform—Resolution BW

```
[ :SENSe ] :WAVeform: BANDwidth | BWIDth [ :RESolution ] <freq>
```

```
[ :SENSe ] :WAVeform: BANDwidth | BWIDth [ :RESolution ] ?
```

Sets the resolution bandwidth. This value is ignored if the function is auto-coupled.

Factory Preset: 20.0 kHz for NADC, PDC, cdma2000, W-CDMA, Basic, Service (E4406A)
500.0 kHz for GSM
2.0 MHz for cdmaOne

Range: 1.0 kHz to 8.0 MHz when
SENSe:WAV:BWID:RES:TYPE GAUSSian
100 mHz to 10.0 MHz when
SENSe:WAV:BWID:RES:TYPE FLATtop
PSA: 10.0 Hz to 10 MHz, for Basic Mode
PSA Option 122: 10 kHz to 80 MHz, for Basic Mode

Remarks: To use this command for E4406A, the appropriate mode should be selected with INSTRUMENT:SElect.

For PSA you must be in the Basic, Analog Modulation, cdmaOne, cdma2000, 1xEV-DO, W-CDMA, GSM, EDGE, NADC, or PDC mode to use this command. Use INSTRUMENT:SElect to set the mode.

Bandwidths > 6.7 MHz require a slight increase in measurement time.

History: PSA modified in revision A.06.00.

Waveform—Query Actual Resolution Bandwidth

```
[ :SENSe ] :WAVeform: BANDwidth [ :RESolution ] :ACTual?
```

Due to memory constraints the actual resolution bandwidth value may vary from the value that you entered. For most applications the resulting difference in value is inconsequential, but for some it is necessary to know the actual value; this query retrieves the actual resolution bandwidth value.

Remarks: To use this command for E4406A, the appropriate mode should be selected with INSTRUMENT:SELECT.

For PSA you must be in the Basic, Analog Modulation, cdmaOne, cdma2000, 1xEV-DO, W-CDMA, GSM, EDGE, NADC, or PDC mode to use this command. Use INSTRUMENT:SELECT to set the mode.

History: E4406A: added in version A.05.00 or later

Waveform—Resolution BW Filter Type

```
[ :SENSE ] :WAVEform:BANDwidth | BWIDth [ :RESolution ] :TYPE  
FLATtop | GAUSSian
```

```
[ :SENSE ] :WAVEform:BANDwidth | BWIDth [ :RESolution ] :TYPE?
```

Selects the type of Resolution BW filter that is used. This is an Advanced control that normally does not need to be changed.

FLATtop - A filter with a flat amplitude response, which provides the best amplitude accuracy.

GAUSSian - A filter with Gaussian characteristics, which provides the best pulse response.

Factory Preset: GAUSSian

Remarks: To use this command for E4406A, the appropriate mode should be selected with INSTRUMENT:SELECT.

For PSA you must be in the Basic, Analog Modulation, cdmaOne, cdma2000, 1xEV-DO, W-CDMA, GSM, EDGE, NADC, or PDC mode to use this command. Use INSTRUMENT:SELECT to set the mode.

Waveform—Decimation of Waveform Display

```
[ :SENSE ] :WAVEform:DECimate [ :FACTor ] <integer>
```

```
[ :SENSE ] :WAVEform:DECimate [ :FACTor ] ?
```

Sets the amount of data decimation done on the IQ data stream. For example, if 4 is selected, three out of every four data points are thrown away. So every 4th data point is kept.

Factory Preset: 1

Range: 1 to 4

Remarks: To use this command for E4406A, the appropriate mode should be selected with INSTRUMENT:SElect.

For PSA you must be in the Basic, Analog Modulation, cdmaOne, cdma2000, 1xEV-DO, W-CDMA, GSM, EDGE, NADC, or PDC mode to use this command. Use INSTRUMENT:SElect to set the mode.

Waveform—Control Decimation of Waveform Display

[:SENSe] :WAVeform:DECimate:STATe OFF | ON | 0 | 1

[:SENSe] :WAVeform:DECimate:STATe?

Sets the amount of data decimation done by the hardware in order to decrease the number of acquired points in a long capture time. This is the amount of data that the measurement ignores.

Factory Preset: OFF

Remarks: To use this command for E4406A, the appropriate mode should be selected with INSTRUMENT:SElect.

For PSA you must be in the Basic, Analog Modulation, cdmaOne, cdma2000, 1xEV-DO, W-CDMA, GSM, EDGE, NADC, or PDC mode to use this command. Use INSTRUMENT:SElect to set the mode.

Waveform—Sweep (Acquisition) Time

[:SENSe] :WAVeform:SWEep:TIME <time>

[:SENSe] :WAVeform:SWEep:TIME?

Sets the measurement acquisition time. It is used to specify the length of the time capture record.

Factory Preset: 2.0 ms

100.0 ms, for Basic Mode (PSA)

10.0 ms, for NADC, PDC

15.0 ms, for iDEN mode (E4406A)

Range: 100 ns to 100 s

Default Unit: seconds

Remarks: To use this command for E4406A, the appropriate mode should be selected with INSTRUMENT:SElect.

For PSA you must be in the Basic, Analog Modulation,

cdmaOne, cdma2000, 1xEV-DO, W-CDMA, GSM, EDGE, NADC, or PDC mode to use this command. Use INSTRUMENT:SElect to set the mode.

Waveform—Trigger Source

```
[ :SENSE ] :WAVEform:TRIGger:SOURce
EXTernal [1] | EXTernal2 | FRAME | IF | IMMEDIATE
| LINE | RFBurst
```

```
[ :SENSE ] :WAVEform:TRIGger:SOURce?
```

Selects the trigger source used to control the data acquisitions.

EXTernal 1 - Front panel external trigger input

EXTernal 2 - Rear panel external trigger input

FRAME - Internal frame timer from front panel input

IF - Internal IF envelope (video) trigger

IMMEDIATE - The next data acquisition is immediately taken (also called free run)

LINE - Internal line trigger

RFBurst - Wideband RF burst envelope trigger that has automatic level control for periodic burst signals (not available when using Option 122)

Factory Preset: IMMEDIATE (free run), for Basic, cdmaOne, NADC, PDC mode

RFBurst, for GSM, iDEN (E4406A) modes

Remarks: To use this command for E4406A, the appropriate mode should be selected with INSTRUMENT:SElect.

For PSA you must be in the Basic, Analog Modulation, cdmaOne, cdma2000, 1xEV-DO, W-CDMA, GSM, EDGE, NADC, or PDC mode to use this command. Use INSTRUMENT:SElect to set the mode.

TRIGger Subsystem

The Trigger Subsystem is used to set the controls and parameters associated with triggering the data acquisitions. Other trigger-related commands are found in the INITiate and ABORt subsystems.

The trigger parameters are global within a selected Mode. The commands in the TRIGger subsystem set up the way the triggers function, but selection of the trigger source is made from each measurement. There is a separate trigger source command in the SENSE:<meas> subsystem for each measurement. The equivalent front panel keys for the parameters described in the following commands, can be found under the **Mode Setup, Trigger** key.

Automatic Trigger Control

:TRIGger[:SEQuence]:AUTO:STATe OFF|ON|0|1

:TRIGger[:SEQuence]:AUTO:STATe?

Turns the automatic trigger function on and off. This function causes a trigger to occur if the designated time has elapsed and no trigger occurred. It can be used with unpredictable trigger sources, like external or burst, to make sure a measurement is initiated even if a trigger doesn't occur. Use TRIGger[:SEQuence]:AUTO[:TIME] to set the time limit.

Factory Preset
and *RST Off for cdma2000, W-CDMA, NADC, PDC, 1xEV-DO

Front Panel
Access **Mode Setup, Trigger, Auto Trig**

Automatic Trigger Time

:TRIGger[:SEQuence]:AUTO[:TIME] <time>

:TRIGger[:SEQuence]:AUTO[:TIME]?

After the measurement is activated the instrument takes a data acquisition immediately upon receiving a signal from the selected trigger source. If no trigger signal is received by the end of the time specified in this command, a data acquisition is taken anyway. TRIGger[:SEQuence]:AUTO:STATE must be on.

Factory Preset: 100.0 ms

Range: 1.0 ms to 1000.0 s
 0.0 to 1000.0 s for cdma2000, W-CDMA, 1xEV-DO

Default Unit: seconds
Front Panel
Access **Mode Setup, Trigger, Auto Trig**

External Trigger Delay

:TRIGger[:SEQuence]:EXTernal[1]|2:DELay <time>
:TRIGger[:SEQuence]:EXTernal[1]|2:DELay?

Sets the trigger delay when using an external trigger. Set the trigger value to zero (0) seconds to turn off the delay.

EXT or EXT1 is the front panel trigger input.

EXT2 is the rear panel trigger input.

Factory Preset: 0.0 s
Range: -100.0 ms to 500.0 ms
Default Unit: seconds
Front Panel
Access: **Mode Setup, Trigger, Ext Rear (or Ext Front), Delay**

External Trigger Level

:TRIGger[:SEQuence]:EXTernal[1]|2:LEVel <voltage>
:TRIGger[:SEQuence]:EXTernal[1]|2:LEVel?

Sets the trigger level when using an external trigger input.

EXT or EXT1 is the front panel trigger input

EXT2 is the rear panel trigger input

Factory Preset: 2.0 V
Range: -5.0 to +5.0 V
Default Unit: volts
Front Panel
Access: **Mode Setup, Trigger, Ext Rear (or Ext Front), Level**

External Trigger Slope

:TRIGger[:SEQuence]:EXTernal[1]|2:SLOPe
NEGative | POSitive

:TRIGger[:SEQuence]:EXTernal[1|2]:SLOPe?

Sets the trigger slope of an external trigger input to either NEGative or POSitive.

EXT or EXT1 is the front panel trigger input.

EXT2 is the rear panel trigger input.

Factory Preset: Positive

Front Panel

Access: **Mode Setup, Trigger, Ext Rear (or Ext Front), Slope**

Frame Trigger Adjust

:TRIGger[:SEQuence]:FRAME:ADJust <time>

Lets you advance the phase of the frame trigger by the specified amount. It does not change the period of the trigger waveform. If the command is sent multiple times, it advances the phase of the frame trigger more each time it is sent.

Factory Preset: 0.0 s

Range: 0.0 to 10.0 s

Default Unit: seconds

Front Panel

Access: None

Frame Trigger Period

:TRIGger[:SEQuence]:FRAME:PERiod <time>

:TRIGger[:SEQuence]:FRAME:PERiod?

Sets the frame period when using the external frame timer trigger. If the traffic rate is changed, the value of the frame period is initialized to the preset value.

Factory Preset: 250.0 μ s for Basic, cdmaOne

4.615383 ms, for GSM

26.666667 ms for cdma2000 and 1xEV-DO

10.0 ms (1 radio frame) for W-CDMA

90.0 ms for iDEN (E4406A)

20.0 ms with rate=full for NADC, PDC

40.0 ms with rate=half for NADC, PDC

Range: 0.0 ms to 559.0 ms for Basic, cdmaOne, GSM,

cdma2000, W-CDMA, 1xEV-DO

1.0 ms to 559.0 ms for iDEN (E4406A), NADC, PDC

Default Unit: seconds

Front Panel

Access: **Mode Setup, Trigger, Frame Timer, Period**

Frame Trigger Sync Source

:TRIGger[:SEQuence]:FRAMe:SYNC EXTFront|EXTRear|OFF

:TRIGger[:SEQuence]:FRAMe:SYNC?

Selects the input port location for the external frame trigger that you are using.

Factory Preset: Off

Remarks: You must be in the Basic, cdmaOne, EDGE (w/GSM), GSM, iDEN (E4406A), NADC, PDC, Service mode to use this command. Use INSTRument:SElect to set the mode.

Front Panel

Access: **Mode Setup, Trigger, Frame Timer, Sync Source**

History Changed firmware revision A.05.00.

Frame Trigger Synchronization Offset

:TRIGger[:SEQuence]:FRAMe:SYNC:OFFSet <time>

:TRIGger[:SEQuence]:FRAMe:SYNC:OFFSet?

Lets you adjust the frame triggering with respect to the external trigger input that you are using.

Factory Preset: 0.0 s

Range: 0.0 to 10.0 s

Default Unit: seconds

Remarks: You must be in the Basic, cdmaOne, GSM, EDGE, iDEN (E4406A), NADC, PDC, Service mode to use this command. Use INSTRument:SElect to set the mode.

History: Revision A.03.27 or later

Front Panel

Access: **Mode Setup, Trigger, Frame Timer, Offset**

Trigger Holdoff

:TRIGger[:SEQuence]:HOLDoff <time>

:TRIGger[:SEQuence]:HOLDoff?

Sets a value of the holdoff time between triggers. After a trigger, another trigger is not allowed until the holdoff time expires. This parameter affects all trigger sources.

Factory Preset: 0.0 s

20.0 ms for iDEN (E4406A)

10.0 ms for NADC or PDC

Range: 0.0 to 500.0 ms

Default Unit: seconds

Front Panel

Access: **Mode Setup, Trigger, Trigger Holdoff**

Video (IF) Trigger Delay

:TRIGger[:SEQuence]:IF:DELay <time>

:TRIGger[:SEQuence]:IF:DELay?

Sets the trigger delay of the IF (video) trigger (signal after the resolution BW filter).

Factory Preset: 0.0 s

Range: -100.0 ms to 500.0 ms

Default Unit: seconds

Front Panel

Access: **Mode Setup, Trigger, Video (IF Envlp), Delay**

Video (IF) Trigger Level

:TRIGger[:SEQuence]:IF:LEVel <ampl>

:TRIGger[:SEQuence]:IF:LEVel?

Sets the trigger level when using the IF (video) trigger.

Factory Preset: -6.0 dBm for cdmaOne, GSM, EDGE, Basic, Service (E4406A), cdma2000, W-CDMA, 1xEV-DO

–20.0 dBm for iDEN (E4406A)
 –30.0 dBm for NADC, PDC
 Range: –200.0 to 50.0 dBm
 Default Unit: dBm
 Front Panel
 Access: **Mode Setup, Trigger, Video (IF Envlp), Level**

Video (IF) Trigger Slope

:TRIGger[:SEQuence]:IF:SLOPe NEGative | POSitive

:TRIGger[:SEQuence]:IF:SLOPe?

Sets the trigger slope when using the IF (video) trigger, to either NEGative or POSitive.

Factory Preset: Positive

Front Panel

Access: **Mode Setup, Trigger, Video (IF Envlp), Slope**

RF Burst Trigger Delay

:TRIGger[:SEQuence]:RFBurst:DELay <time>

:TRIGger[:SEQuence]:RFBurst:DELay?

Sets the trigger delay when using the RF burst (wideband) trigger.

Factory Preset: 0.0 μ s

Range: –100.0 ms to 500.0 ms

Default Unit: seconds

Front Panel

Access: **Mode Setup, Trigger, RF Burst, Delay**

RF Burst Trigger Level

:TRIGger[:SEQuence]:RFBurst:LEVel <rel_power>

:TRIGger[:SEQuence]:RFBurst:LEVel?

Sets the trigger level when using the RF Burst (wideband) Trigger. The value is relative to the peak of the signal. RF Burst is also known as RF Envelope.

Factory Preset: -6.0 dB

Range: -25.0 to 0.0 dB
-200.0 to 0.0 dB for NADC, PDC

Default Unit: dB

Front Panel

Access: **Mode Setup, Trigger, RF Burst, Peak Level**

RF Burst Trigger Slope

:TRIGger[:SEquence]:RFBurst:SLOPe NEGative | POSitive

:TRIGger[:SEquence]:RFBurst:SLOPe?

Sets the trigger slope when using the RF Burst (wideband) Trigger.

Factory Preset: Positive

Remarks: You must be in the cdmaOne, cdma2000, W-CDMA mode to use this command. Use :INSTrument:SElect to set the mode.

Front Panel

Access: **Mode Setup, Trigger, RF Burst, Slope**

5 Concepts

This chapter provides details about the GSM and EDGE communications systems, and explains how the various measurements are performed by the instrument. Suggestions for optimizing and troubleshooting your setup are provided, along with a list of related Agilent documents that are referenced for further information.

What are GSM and EDGE?

The Global System for Mobile communication (GSM) digital communications standard defines a voice and data over-air interface between a mobile radio and the system infrastructure. This standard was designed as the basis for a digital cellular radio communications system. A base station control center (BSC) is linked to multiple base transceiver station (BTS) sites which provide the required coverage.

EDGE (Enhanced Data Rates for GSM Evolution) enhances the GSM standard by implementing a new modulation format and filtering designed to provide higher data rates in the same spectrum. EDGE and GSM signals can be transmitted on the same frequency, occupying different timeslots, and both use existing GSM equipment. EDGE has also been adopted as the basis for IS-136HS.

The GSM digital communications standard employs an 8:1 Time Division Multiple Access (TDMA) allowing eight channels to use one carrier frequency simultaneously. The 270.833 kbits/second raw bit rate is modulated on the RF carrier using Gaussian Minimum Shift Keying (GMSK).

The standard includes multiple traffic channels, a control channel, and a cell broadcast channel. The GSM specification defines a channel spacing of 200 kHz.

GSM 900, GSM 450, GSM 480, GSM 850, DCS 1800, and PCS 1900 are GSM-defined frequency bands. The term GSM 900 is used for any GSM or EDGE system operating in the 900 MHz band, which includes P-GSM, E-GSM, and R-GSM. Primary (or standard) GSM 900 band (P-GSM) is the original GSM band. Extended GSM 900 band (E-GSM) includes all the P-GSM band plus an additional 50 channels. Railway GSM 900 band (R-GSM) includes all the E-GSM band plus additional channels.

GSM 450, GSM 480, GSM 700, and GSM 850 are additional GSM-defined frequency bands, that provide additional bandwidth availability.

DCS 1800 is an adaptation of GSM 900, created to allow for smaller cell sizes for higher system capacity. PCS 1900 is intended to be identical to DCS 1800 except for frequency allocation and power levels. The term GSM 1800 is sometimes used for DCS 1800, and the term GSM 1900 is sometimes used for PCS 1900. For specifics on the bands, refer to Table 5-1.

Table 5-1 EDGE and GSM Band Data

| | P-GSM (GSM 900) | E-GSM (GSM 900) | R-GSM (GSM 900) | DCS 1800 (GSM 1800) | PCS 1900 (GSM 1900) | GSM 450 | GSM 480 | GSM 700 | GSM 850 |
|--|-----------------------------------|-----------------------------------|-----------------------------------|--|--|-----------------------------------|-----------------------------------|-----------------------------------|-----------------------------------|
| Uplink (MS Transmit) | 890 to 915 MHz | 880 to 915 MHz | 876 to 915 MHz | 1710 to 1785 MHz | 1850 to 1910 MHz | 450.4 to 457.6 MHz | 478.8 to 486 MHz | 777 to 792 MHz | 824 to 849 MHz |
| Downlink (BTS Transmit) | 935 to 960 MHz | 925 to 960 MHz | 921 to 960 MHz | 1805 to 1880 MHz | 1930 to 1990 MHz | 460.4 to 467.6 MHz | 488.8 to 496 MHz | 747 to 762 MHz | 869 to 894 MHz |
| Range (ARFCN) | 1 to 124 | 0 to 124 and 975 to 1023 | 1 to 124 and 955 to 1023 | 512 to 885 | 512 to 810 | 259 to 293 | 306 to 340 | 438 to 511 | 128 to 251 |
| TX/RX Spacing (Freq.) | 45 MHz | 45 MHz | 45 MHz | 95 MHz | 80 MHz | 45 MHz | 45 MHz | 30 MHz | 45 MHz |
| TX/RX Spacing (Time) | 3 timeslots | 3 timeslots | 3 timeslots | 3 timeslots | 3 timeslots | 3 timeslots | 3 timeslots | 3 timeslots | 3 timeslots |
| Modulation Data Rate GMSK (kbits/s) 8PSK (kbits/s): | 270.833 812.499 | 270.833 812.499 | 270.833 812.499 | 270.833 812.499 | 270.833 812.499 | 270.833 812.499 | 270.833 812.499 | 270.833 812.499 | 270.833 812.499 |
| Frame Period | 4.615 ms | 4.615 ms | 4.615 ms | 4.615 ms | 4.615 ms | 4.615 ms | 4.615 ms | 4.615 ms | 4.615 ms |
| Timeslot Period | 576.9 μ s | 576.9 μ s | 576.9 μ s | 576.9 μ s | 576.9 μ s | 576.9 μ s | 576.9 μ s | 576.9 μ s | 576.9 μ s |
| GSM Bit and Symbol Period | 3.692 μ s | 3.692 μ s | 3.692 μ s | 3.692 μ s | 3.692 μ s | 3.692 μ s | 3.692 μ s | 3.692 μ s | 3.692 μ s |
| EDGE Symbol Period | 3.692 μ s | 3.692 μ s | 3.692 μ s | 3.692 μ s | 3.692 μ s | 3.692 μ s | 3.692 μ s | 3.692 μ s | 3.692 μ s |
| Modulation GSM EDGE | 0.3 GMSK 3 π /8 8PSK | 0.3 GMSK 3 π /8 8PSK | 0.3 GMSK 3 π /8 8PSK | 0.3 GMSK 3 π /8 8PSK | 0.3 GMSK 3 π /8 8PSK | 0.3 GMSK 3 π /8 8PSK | 0.3 GMSK 3 π /8 8PSK | 0.3 GMSK 3 π /8 8PSK | 0.3 GMSK 3 π /8 8PSK |
| Channel Spacing | 200 kHz | 200 kHz | 200 kHz | 200 kHz | 200 kHz | 200 kHz | 200 kHz | 200 kHz | 200 kHz |
| TDMA Mux | 8 | 8 | 8 | 8 | 8 | 8 | 8 | 8 | 8 |
| Voice Coder Bit Rate | 13 kbits/s | 13 kbits/s, 5.6 kbits/s | 13 kbits/s | 13 kbits/s | 13 kbits/s | 13 kbits/s | 13 kbits/s | 13 kbits/s | 13 kbits/s |

What are GSM and EDGE?

The framing structure for GSM and EDGE measurements is based on a hierarchical system consisting of timeslots, TDMA frames, multiframes, superframes, and hyperframes. One timeslot consists of 156.25 (157) symbol periods including tail, training sequence, encryption, guard time, and data bits. Eight of these timeslots make up one TDMA frame. Either 26 or 51 TDMA frames make up one multiframe. Frames 13 and 26 in the 26 frame multiframe are dedicated to control channel signaling. For more detail about timeslots see [“Timeslots” on page 525](#).

Frequently Used Terms

Mobile Stations and Base Transceiver Stations

The cellular system includes the following:

- Base transceiver stations, referred to as BTS
(frequency ranges dependent on the standard; refer to Table 5-1 on page 523)
- Mobile stations, referred to as MS
(frequency ranges dependent on the standard; refer to Table 5-1 on page 523)

Uplink and Downlink

Uplink is defined as the path from the mobile station to the base transceiver station. Downlink is the path from the base transceiver station to the mobile station.

ARFCN

An ARFCN is the Absolute Radio Frequency Channel Number used in EDGE and GSM systems. Each RF channel is shared by up to eight mobile stations using Time Division Multiple Access (TDMA). The ARFCN is an integer (in a range dependent on the chosen standard, refer to Table 5-1 on page 523) which designates the carrier frequency.

Timeslots

EDGE and GSM use Time Division Multiple Access (TDMA) which divides each RF channel into eight individual timeslots, thus allowing eight users to share a single carrier frequency. Users are synchronized to transmit in series, each in their assigned timeslot. A user may only transmit every 4.62 ms during their timeslot which is 577 μ s long. The eight timeslots are numbered 0 to 7. The 4.62 ms required to cycle through all eight timeslots is called a frame.

In a GSM signal each 577 μ s timeslot has a length of 156.25 bit periods, which consists of 148 data bits and 8.25 guard bits.

For an EDGE signal each 577 μ s timeslot has a length of 156.25 symbol periods, which consist of 142 data symbols of 3 bits each, 8.25 guard symbols of 3 bits each, and 6 “tail bit” symbols of 3 bits each, for a total of 426 data bits, 18 “tail bits” and 24.75 guard bits. The same frame length of 4.62 ms is required to cycle through the frame.

In a TDMA system, the shape and timing of each transmitted burst must be controlled carefully to avoid overlapping timeslots.

Transmit Power Measurement Concepts

Purpose

Transmit Power is the measure of in-channel power for GSM and EDGE systems. Mobile stations and base transceiver stations must transmit enough power, with sufficient modulation accuracy, to maintain a call of acceptable quality without leaking into frequency channels or timeslots allocated for others. GSM and EDGE systems use dynamic power control to ensure that each link is maintained with minimum power. This gives two fundamental benefits: overall system interference is kept to a minimum and, in the case of mobile stations, battery life is maximized.

The Transmit Power measurement determines the average power for an RF signal burst at or above a specified threshold value. The threshold value may be absolute, or relative to the peak value of the signal.

At the base transceiver station, the purpose of the Transmit Power measurement is to determine the power delivered to the antenna system on the radio-frequency channel under test. The Transmit Power measurement verifies the accuracy of the mean transmitted RF carrier power. This can be done across the frequency range and at each power step.

Measurement Method

The instrument acquires a GSM or EDGE signal in the time domain. The average power level above the threshold is then computed and displayed. This measurement uses the “power-above-threshold” method instead of the “useful part of the burst” method defined in the GSM standards. The measured Transmit Carrier Power is very nearly the same for these two methods. The power-above-threshold method has the advantages of being faster and allows power measurements to be made at somewhat lower power levels. It also has the advantage of not requiring the carrier to have a valid TSC (Training Sequence Code).

Note that this measurement does not provide a way to specify which timeslot is to be measured. Therefore if multiple timeslots are on, they should all be set at the same power level, or the levels of those timeslots to be excluded need to be kept below the threshold level. If you want to measure Transmit Carrier Power using the GSM specified useful part of the burst method, use the Power vs. Time or EDGE Power vs. Time measurements, which also measure the power ramping of the burst.

GSMK Power vs. Time Measurement Concepts

Purpose

NOTE

This measurement is designed for GSM. For EDGE measurements see [“EDGE Power vs. Time Measurement Concepts” on page 542](#)

Power vs. Time (PvT) measures the mean transmit power during the “useful part” of GSM bursts and verifies that the power ramp fits within the defined mask. Power vs. Time also lets you view the rise, fall, and “useful part” of the GSM burst. Using the “Multi-Slot” function, up to eight slots in a frame can be viewed at one time.

GSM is a Time Division Multiple Access (TDMA) scheme with eight time slots, or bursts, per RF channel. If the burst does not occur at exactly the right time, or if the burst is irregular, then other adjacent timeslots can experience interference. Because of this, the industry standards specify a tight mask for the fit of the TDMA burst.

The Power vs. Time measurement provides masks for both BTS (Base Transceiver Station) and MS (mobile station). The timing masks are referenced to the transition from bit 13 to bit 14 of the midamble training sequence. For GSMK measurements, the 0 dB reference is determined by measuring the mean transmitted power during the “useful part” of the burst. You can also define a user configurable limit mask to apply to the measured burst using SCPI commands (refer to the [“GSMK Power vs. Time Measurement Keys” on page 204](#)).

The GSM specifications defines the “useful part” of the normal GSM burst as being the 147 bits centered on the transition from bit 13 to bit 14 (the “T0” time point) of the 26 bit training sequence.

The PvT measurement may also be used to measure GPRS (General Packet Radio Service) signals. See [“Making GPRS PvT measurements” on page 529](#) for details.

Measurement Method

The instrument acquires a GSM signal in the time domain. The “T0” point and the useful part are computed. If Burst Sync is set to **Training Seq**, a GSM demodulation is performed to find “T0”. If Burst Sync is set to **RF Amptd**, an approximation of “T0” is used without performing a demodulation. The average power in the useful part is then computed and displayed, and the GSM limit mask is applied. A **PASS** annunciator appears in the instrument display when the burst fits within the bounds of the mask.

Measurement Adjustments

There are five keys that are frequently used to change power vs. time measurement settings. These are the **Timeslot**, **Burst Type**, and **TSC (Std)** keys located in the **Frequency** menu, and the **Trig Source** and **Burst Sync** keys located in the **Meas Setup** menu.

First, press **Trig Source**. The trigger source determines how the analyzer acquires a frame of data. If **Ext Front** or **Ext Rear** is selected an external, known reference in time will be provided for the data acquisition. If **RF Burst** is selected the rising edge of a burst is used to initiate data acquisition.

Once data is acquired, the time record is interpreted as a sequence of eight slots. When an **Ext Front** or **Ext Rear** trigger source is selected, the trigger is assumed to be positioned near the beginning of the base station's timeslot. However, if the external trigger is more than 25% away from the burst, the analyzer does not identify the burst and fails to place a mask on it. If the external trigger is too far away from the burst, you can compensate for this by entering a value for the external trigger delay to bring the burst back into the alignment range of the mask. When the external trigger is not coincident in time with the beginning of the base station's timeslot, press **Mode Setup**, then use the **Trigger** key to select the trigger; once the trigger is selected the **Delay** key allows you to enter a value for trigger delay.

When **Trig Source** is set to **RF Burst**, data acquisition is delayed until the rising edge of an active timeslot burst. The issue of timeslot tolerance then applies to any subsequent active time bursts within the frame. Thus, the analyzer uses the rising edge of the RF burst to define the beginning of the first timeslot of the data record.

The analyzer does not perform the protocol analysis that is necessary to identify which absolute slot number a frame is triggering on. If it is necessary to position the measurement on an absolute slot within the GSM frame, an external trigger must be used. As an alternative, a burst of interest can be identified by placing a unique training sequence in it, and setting **TSC (Std)** to manual; this requires that you are able to configure the burst to contain a specified training sequence.

When **Burst Sync** is set to **Training Seq** the analyzer demodulates the burst to identify the training sequence and bit timing, so it can accurately position the limit mask according to the standard. In this case, the **Burst Type** setting (the choices are **Normal**, **Sync**, and **Access**) tells the analyzer demodulation algorithm which burst bit structure should be used.

If **Burst Sync** is set to **RF Amptd**, demodulation is not used and the analyzer then positions the mask in relation to the rising edge of the RF burst.

The timeslot feature is an offset feature that is used to select the “burst of interest”. The “burst of interest” represents the portion of the acquired data record that receives analysis for interpretation as a valid burst; this is the burst to which a limit mask is applied and for which power calculations are generated. When the multi-slot view is selected, all slots in the view are tested for application of the limit mask, but the burst of interest is the one that is indicated in blue text in the multi-slot table.

For example, if **Timeslot** is set to **On** and 3 is selected, the burst of interest is offset by 3 slots from the beginning of the acquired time record, and the limit mask is applied to this burst. If the selected timeslot attempts to locate a burst of interest where no burst is active, the mask application fails. Timeslot functions as a time pointer offset in the acquired data record, regardless of the **Trig Source** setting.

Once determined, the burst of interest is demodulated if **Burst Sync** is set to **Training Seq**. **TSC (Std)** applies only when **Burst Sync** is set to **Training Seq**.

When **TSC (Std)** is set to manual, demodulation searches for that specific training sequence number. If it is not found, a limit mask is not applied, and an error is reported. When **TSC (Std)** is set to **Auto**, demodulation searches the burst of interest for any of the eight standard training sequences, and uses it for to find the true center of the burst so the mask can be applied accurately.

Making GPRS PvT measurements

You can make PvT measurements of GPRS signals if you have at least one inactive slot. The inactive slot is necessary to allow synchronization of multi-slot bursts. Refer to the next section, “Making Multi-Slot Measurements, to configure the measurement timeslots. See [Figure 2-42, “GPRS Power vs. Time Result - Multi-Slot View \(2 slots shown\)”](#) on page 99 for an example of a GPRS PvT result.

Making Multi-Slot Measurements

First set **Meas Time** to the number of slots you want to view, then activate the **Multi-Slot** view, which is found in the **View/Trace** menu.

You can use the following method to ensure that timeslots 0 - 7 in the transmitted frame correlate with timeslots 0 - 7 as viewed in the transmitter tester:

- Use an external trigger. The Agilent ESG signal generator series, for example, has an “event 1” rear panel output which triggers at the beginning of the frame. Connect the trigger from the signal generator to an external trigger input connector on the transmitter tester, then select the appropriate connector using the **Trigger Source** key in the **Meas Setup** menu.

Selecting the Burst of Interest

The burst of interest is indicated in blue text in the table shown below the multi slot view. Press the **Burst** view key to view the burst of interest.

- If a timeslot contains a burst with a standard training sequence that is unique to the frame, the specified training sequence can be used to select the timeslot in which the burst of interest occurs. Set **Trigger** to **RF Burst**, set **Burst Sync** to **Training Seq**, and in the **Freq/Chan** menu set **Timeslot** to **OFF**. Then set **TSC (Std)** to **Man** (manual) and enter the training sequence number.
- If only one timeslot in a given frame contains a burst with a standard training sequence, then the specified training sequence can be used to select the timeslot in which the burst of interest occurs. Set **Trigger** to **RF Burst**, **Burst Sync** to **Training Seq**, and in the **Freq/Chan** menu set **Timeslot** **OFF**. Then set **TSC (Std)** to **Auto**, and the trigger automatically searches through the available standards for a matching training sequence number.

Changing the View

The **View/Trace** key accesses a menu that allows you to select the desired view of the measurement from the following selections:

- **Burst** - views the entire burst of interest as determined by the current trigger source, burst sync, training sequence, and timeslot settings. To view a different burst of interest you must set these parameters for the selected timeslot. To view multiple slots use the **Multi-Slot** key described below. See [Figure 2-39, “GMSK Power vs. Time Result - Burst View”](#) on page 97.
- **Rise & Fall** - zooms in on the rising and falling portions of the burst being tested. See [Figure 2-40, “GMSK Power vs. Time Result - Rise & Fall View”](#) on page 98.

NOTE

The limit test is still performed on the entire burst (viewed using the **Burst** menu) when **Rise & Fall** is selected.

- **Multi-Slot** - views the entire sweep as specified by the current **Meas**

Time setting. Power levels for each active slot are listed in a table below the timeslot display. Also shown in the table under **1st Error Pt.** is the point in time at which the signal level first exceeds the limit, which helps to identify the slot where a failure first occurs.

Use the **Meas Time** key located in the **Meas Setup** menu to select up to eight slots. Use the **Timeslot** and **TSC** keys in the **Frequency/Channel** menu to select the slot you wish to activate. Setting **Timeslot** to **ON** and selecting a specific slot results in activating a measurement of that slot only (**Timeslot On** can be used to isolate a failure to a specific slot). When **Timeslot** is set to **OFF**, all active slots are tested against the mask.

Using a signal generator you can synchronize the multi-slot view so the frame (or portion of the frame) you are viewing starts with the slot you have selected. See [“Making Multi-Slot Measurements” on page 529.](#)

You can switch from the multi-slot view directly to the burst or rise and fall views of the slot that is currently active. The **Scale/Div** key under the **Span/Y Scale** menu can be used to enlarge your view of this signal.

Changing the Display

The **Display** key allows you to turn the limit mask on and off. This also disables the mask limit test, but still calculates the power in the useful part.

Measurement Results

The views available under the **View/Trace** menu are **Burst**, **Rise & Fall**, and **Multi-Slot**. See [“Changing the View” on page 543.](#)

Information shown in the left margin of the displays include:

- **MaxP** - This is total input power allowed for the measurement. This value is coupled to the internal RF **Input Atten** setting.
- **ExtAt** - This value reflects the **External RF Atten** setting.
- **Sync** - The **Burst Sync** setting used in the current measurement
- **Trig** - The **Trigger Source** setting used in the current measurement

The **Mean Transmit Power** is displayed at the bottom left of the Burst and Rise & Fall views:

- **Mean Transmit Power** - This is the RMS average power across the “useful” part of the burst, or the 147 bits centered on the transition from bit 13 to bit 14 (the “T0” time point) of the 26 bit training sequence. An RMS calculation is performed and displayed regardless of the averaging mode selected for the trace data.

If Averaging = ON, the result displayed is the RMS average power of all bursts measured. If Averaging = OFF, the result is the RMS average power of the single burst measured. This is a different measurement result from Mean Transmit Pwr, below.

The **Current Data** displayed at the bottom of the Burst and Rise & Fall views include:

- **Mean Transmit Pwr** - This result appears only if Averaging = ON. It is the RMS average of power across the “useful” part of the burst, for the current burst only. If a single measurement of “n” averages has been completed, the result indicates the Mean Transmit Pwr of the last burst. The RMS calculation is performed and displayed regardless of the averaging mode selected for the trace data. This is a different measurement result from Mean Transmit Power, above.
- **Max Pt.** - Maximum signal power point in dBm
- **Min Pt.** - Minimum signal power point in dBm
- **Burst Width** - Time duration of burst at -3 dB power point (half-power)
- **Mask Ref Pwr Midamble** - The Mask Reference Power is the average power in dBm of the middle 16 symbols in the midamble. The times displayed are the corresponding start and stop times of the middle 16 symbols.
- **1st Error Pt** - (Error Point) The time (displayed in ms or μ s) indicates the point on the X Scale where the first failure of a signal was detected. Use a marker to locate this point in order to examine the nature of the failure.

The table in the lower portion of the multi-slot view shows the output power in dBm for each timeslot, as determined by the integer (1 to 8) entered in the **Meas Setup, Meas Time** setting. Output power levels are presented for the active slots; a dashed line appears for any slot that is inactive. The timeslot that contains the burst of interest is highlighted in blue.

GMSK Phase and Frequency Error Measurement Concepts

NOTE This measurement is designed for GSM only.

Purpose

Phase and frequency error are the measures of modulation quality for GSM systems. Since GSM systems use relative phase to transmit information, the phase and frequency accuracy of the transmitter are critical to the systems' performance and ultimately affect range.

GSM receivers rely on the phase and frequency quality of the 0.3 GMSK signal in order to achieve the expected carrier to noise performance. A transmitter with high phase and frequency error is often still able to support phone calls during a functional test. However, it tends to create difficulty for mobiles trying to maintain service at the edges of the cell, with low signal levels, or under difficult fading and Doppler conditions.

Measurement Method

The phase error of the test signal is measured by computing the difference between the phase of the transmitted signal and the phase of a theoretically perfect signal.

The instrument samples the transmitter output in order to capture the actual phase trajectory. This is then demodulated and the ideal phase trajectory is mathematically derived. Subtracting one from the other results in an error signal.

This measurement allows you to display these errors numerically and graphically on the analyzer display. It also allows you to view a binary representation of the demodulated data bits.

Measurement Adjustments

NOTE The factory default settings provide a GSM compliant measurement. For special requirements, you may need to change some of the settings. Press **Meas Setup, More (1 of 2), Restore Meas Defaults** at any time to return all parameters for the current measurement to their default settings.

Select the desired ARFCN, center frequency, timeslot, burst type, and TSC (Training Sequence Code) as described in the section titled ["FREQUENCY Channel Key Menu"](#) on page 143.

Select the type of carrier to measure. Press **Mode Setup, Radio, Carrier**

and select **Burst** to measure a burst carrier, or **Cont** to measure a continuous carrier from a non-bursting base station.

When **Training Sequence** is selected as the burst sync for this measurement, the **Timeslot** selection to determine which timeslot to measure. For example, if **Timeslot** is set to 2, the measurement is made on the timeslot number 2. Be careful when adding delay in the Trigger setup, as this measurement does not take into account trigger delay when checking for a valid burst. If there is sufficient delay added (usually more than 25% of a timeslot), the burst might not be detected.

You can make measurements of continuous GMSK signals by synchronizing the measurement to the training sequence. When using the training sequence as the burst sync, the entire data record is demodulated, and the measurement searches for a training sequence. To select a specific training sequence press **Frequency, TSC (Std)** to toggle from **AUTO** to any of 8 standard sequences numbered from 0 to 7.

You can also make continuous carrier measurements without synchronization. Set **Burst Sync** to **RF Amplitd** in the **Meas Setup** menu. The measurement begins demodulation without searching for a sync word.

Press **Measure, Phase & Freq** to immediately make Phase and Frequency Error the active measurement.

To change any of the measurement parameters from the factory default values, refer to the [“GMSK Phase and Frequency Error Measurement Keys” on page 197](#) for this measurement.

Changing the View

The **View/Trace** key allows you to select the desired view of the measurement from the following:

- **I/Q Error (Quad-View)** - Provides a combination view including

Window 1: Phase Error

Window 2: Phase Error with Freq

Window 3: RF Envelope

Window 4: Numeric Results and demodulated bits

Any of these windows can be selected (using the **Next Window** key) and made full size (using the **Zoom** key).

- **I/Q Measured Polar Vector** - Provides a view of numeric results and a polar vector graph.

Window 1: Numeric Results

Window 2: Polar Vector Graph

- **Data Bits** - Provides a view of the numeric results and data bits with

the sync word (TSC) highlighted.

The menus under the **SPAN X Scale** and **AMPLITUDE Y Scale** keys are context dependent upon the selected window (graph type). The **SPAN X Scale** parameters are in units of time or bits, dependent on the view selected. The **AMPLITUDE Y Scale** parameters are in units of dB or degrees, dependent on the view selected. All of the softkey labels are blank when **I/Q Measured Polar Vector**, or **Data Bits** are selected.

Changing the Display

The **Display** key allows you to turn the bit dots on and off.

GMSK Output RF Spectrum Measurement Concepts

Purpose

NOTE This measurement is designed for GSM. For EDGE Output RF Spectrum measurements see [“EDGE Output RF Spectrum Measurement Concepts”](#) on page 549.

The Output RF Spectrum measurement is the GSM version of the adjacent channel power (ACP) measurement. Either a single offset is measured with corresponding traces or up to 15 offsets are measured and a table is displayed. In spectrum due to modulation measurements a sweep spectrum display of -1.8 MHz to +1.8 MHz from the carrier can be viewed.

The output RF spectrum measurements determine the spectral energy emitted into the adjacent channels. Excessive amounts of energy spilling into an adjacent frequency channel could interfere with signals being transmitted to other MS or BTS. The measurements are divided into two main groups: spectrum due to the 0.3 GMSK modulation and noise, and spectrum due to switching transients (burst ramping).

Since GSM is a TDMA format, RF power is being switched on and off depending on whether the actual burst is being transmitted. The switching of power causes spectral splatter at frequencies other than that being transmitted by the carrier. Fast transitions in the time domain causes switching transients that have high frequency content associated with them.

NOTE The default output RF spectrum measurements do not perform tests at frequency offsets greater than 1800 kHz from the carrier.

Measurement Method

In this measurement, the transmitter (source) is set to transmit a GSM frame at a given channel (frequency). The instrument acquires a time record at a particular offset from the channel being transmitted. The method of acquiring the time record is either a FFT/Inverse-FFT method, or a direct time domain (DTD) method, depending on the offset. These two methods, and when they are used, are described below. When the offset is zero, the instrument is said to be measuring the carrier. For a given offset frequency from the carrier, the transmitter must not exceed a certain power level relative to the carrier. The GSM specification defines the offsets and their maximum absolute and relative power levels.

The general steps in making the measurement are as follows:

- Acquire time record (using either FFT or DTD methods, described below)
- Synchronize for gating on the carrier - finds 50% and 90% portion of burst for Spectrum Due to Modulation portion of the test
- Measure power of the carrier
- Compare each offset power to reference to get relative power level

The method of acquiring the time record is dependent on accuracy and dynamic range. With no pre-ADC filter (infinite bandwidth), the entire IF bandwidth of the IF signal is hitting the analog to digital converter (ADC). The ADC gain is set based on the peak level at its input. The dynamic range (noise floor) of the ADC is dependent on the gain selected. For the type of signals being measured, the highest energy within the IF bandwidth is at the carrier. Therefore, the lowest dynamic range (highest noise floor) of the ADC occurs when the full energy of the carrier is input to the ADC.

All offsets measured using the FFT method are done with the instrument tuned such that the carrier is at the center of the IF bandwidth. Therefore, the dynamic range of the offsets measured using the FFT method is the same as that for the carrier. The dynamic range requirement generally increases as the offset frequency increases. If the dynamic range requirement exceeds what is available by FFT method, the direct time domain (DTD) method utilizing the pre-ADC filter is used.

The **Direct Time Break Freq** key setting is the first offset frequency which is measured using the DTD method. Its range is determined by assuring no aliasing occurs on FFT offsets and that the dynamic range requirements are met.

The FFT method acquires a wideband signal (1.55 MHz) in a flattop filter. An FFT is performed to get the spectrum of the GSM signal. The resolution bandwidth filter can now be applied mathematically to the spectrum at multiple offsets, with an inverse-FFT performed on the data which passes the filter. In this way, multiple offsets are acquired from one time record and LO setting. Since the resolution bandwidth filter is a mathematical formula, it can be any shape and size, and is perfect. The measurement uses the 5-pole synchronously tuned filter that the GSM standard specifies.

The primary disadvantage to the FFT method is that the acquisition must include the carrier. The high energy of the carrier causes the ADC to range down, thus lowering the dynamic range. At large offsets, the dynamic range requirement is very challenging so the direct time domain (DTD) method is used. The LO is tuned to the particular offset and the pre-ADC filter is used to reduce the carrier. This allows the

ADC to range up, giving higher dynamic range. The disadvantage to this method is that each offset measured has its own time record acquisition and LO tune position, and this causes the measurement to slow down compared to FFT offsets. The 5-pole synchronously tuned filter is approximated by utilizing a digital Gaussian filter and setting its equivalent noise bandwidth to that of the 5-pole synchronously tuned filter. For these DTD offset frequencies, the filter has closer-to-ideal 5-pole behavior (< 1% tolerance) than does a 10% tolerance, 5-pole analog filter.

Regardless of how the time record is obtained for a particular offset, the power must be measured and compared to the reference power. There are two measurements being made for the test: output RF spectrum due to modulation and the output RF spectrum due to switching transients. The GSM standard specifies which offsets get which tests. In these two modes, the following conditions are met:

- In the output RF spectrum due to modulation measurement, the average value during at least 40 bits between bit 87 and 132 (approximately equivalent to the 50% to 90% portion of the burst, excluding midamble) is retained. The vertical lines mark the section of the burst over which the measurement is made. If multiple bursts are examined, an average of the average values is calculated. The relative power (difference between the average power of the burst at zero offset and the average power of the burst at the indicated offset) and the absolute power are displayed.
- In the output RF spectrum due to switching transients, the peak value of the whole frame is retained. The reference power of reference due to switching is the average power of the useful part of the burst with at least 300 kHz RBW. The relative power (difference between the mean transmit power of the burst at zero offset and the peak power of the burst at the indicated offset) and the absolute power are displayed.

The GSM standard specifies the tests are run on specified offsets from the carrier. The instrument identifies this as single offset or multiple offset modes. The measurement made in these two modes is the same, except that the multiple offset mode automatically makes the measurement at all the specified offsets frequencies and lists the results in a table at the end of the measurement.

In the output RF spectrum due to modulation measurement, setting the modulation method to discrete obtains results from specified offsets from the carrier as defined in the standard; the results are displayed in a table. When set to sweep, the measurement obtains results of a span extending to 1800 kHz from both sides of the carrier, measured in 10 kHz steps; the results are displayed as a spectrum.

The GMSK ORFS Modulation result view shows a single-offset (Examine) trace for an entire GSM slot. The vertical bars show the portion used to measure power due to modulation.

The RF envelope trace is displayed. If averaging is turned on, the trace is then averaged with previous traces. For the modulation measurement, you may select the type of trace averaging, either log-power averaged (Video) or power averaged (RMS). For the switching transients measurement, the peak of the traces is used. For modulation, the displayed value is the average of points within the vertical bars. For transients, the displayed value is the max of all points for all traces (Max of Peak) over the entire frame.

Changing the View

If the Multi-Offset measurement has been chosen and the Meas Type is Mod & Switch, pressing the **View/Trace** key allows you to select the desired view of the current measurement. If the Meas Type is Modulation, the **Switching Margin and Limit** view is unavailable. If the Meas Type is Switching, the **Modulation Margin & Limit** view is unavailable.

GMSK ORFS Measurements on a Single Bursted Slot

The PSA or E4406A can be set up to make an ORFS measurement on a single bursted EDGE slot if all of the offsets measured are less than the Direct Time Break Frequency using the following procedure:

1. Press **MODE, GSM**.
2. Press **MEASURE, GMSK Output RF Spectrum**.
3. Press **Meas Setup, More (1 of 2), Advanced, Direct Time Break Freq** and set the Direct Time Break frequency to be greater than the furthest offset measured. The maximum value that can be set is 775.0 kHz.
4. Press **Meas Setup, Meas Type, Modulation**.
5. Press **Meas Setup, Multi-Offset Freq List, Custom** and set the offsets to be measured.
6. Press **Trig Source** and select the trigger type appropriate for your measurement either **External Front, External Rear, or RF Burst**. If the selection is RF Burst, adjust the RF burst trigger Peak Level so that the instrument does not trigger when there is no signal present. Press **Mode Setup, Trigger, RF Burst, Peak Level**. When set properly, the instrument displays the message "Waiting for Trigger".
7. Press the **Restart** or the **Single** front-panel key or send a remote command to initiate the measurement.

GMSK Tx Band Spur Measurement Concepts

Purpose

NOTE This measurement is designed for GSM. For EDGE Tx Band Spur measurements see “EDGE Tx Band Spur Measurement Concepts” on page 554.

The Tx Band Spur measurement checks that the transmitter does not transmit undesirable energy into the transmit band. This energy may cause interference for other users of the GSM system.

Measurement Method

This is a base station only measurement. The transmitter should be set at its maximum output power on all time slots. This measurement is performed at RF channels B (bottom), M (middle), and T (top). Refer to the following table.

| Band | Tx Band Edge (MHz) | | BOTTOM | | MIDDLE | | TOP | |
|----------|--------------------|------|-------------|--------|-------------|--------|-------------|--------|
| | Low | High | Freq (MHz) | ARFC N | Freq (MHz) | ARFC N | Freq (MHz) | ARFC N |
| P-GSM | 935 | 960 | 935.20 0 | 1 | 947.60 0 | 63 | 959.80 0 | 124 |
| E-GSM | 925 | 960 | 925.20 0 | 975 | 942.60 0 | 38 | 959.80 0 | 124 |
| R-GSM | 921 | 960 | 921.20 0 | 955 | 940.60 0 | 28 | 959.80 0 | 124 |
| DCS 1800 | 1805 | 1880 | 1805.2 0 | 512 | 1842.6 0 | 699 | 1879.8 0 | 885 |
| PCS 1900 | 1930 | 1990 | 1930.2 0 | 512 | 1960.0 0 | 661 | 1989.8 0 | 810 |

The transmit band spectrum is measured in several frequency segments using resolution bandwidths as specified by the standard (see the list below).

Table 5-2

| Frequency Offset | Resolution Bandwidth |
|--|----------------------|
| ≥ 1.8 MHz and < 6 MHz and inside Tx band | 30 kHz |
| ≥ 6 MHz and inside Tx band | 100 kHz |

The mean transmit power is measured first using the “power-above-threshold” method (see the Transmit Power measurement for detail), and then used as a reference for the measurement limit lines if limits are used. The spectrums, which are below or above the carrier frequency and within the transmit band, are measured.

For each spectrum segment, the measurement looks for the spectrum peak closest to the limit and saves the data. The peak of all segments is reported as the *Worst Spur*. The amplitude difference from the peak to the limit line (Δ from Limit), and from the peak to the mean transmit power (Δ from Carrier) are displayed. The frequency difference from the peak to the carrier frequency (Offset Freq) is also displayed. If the peak goes above the limit line, the display indicates *FAIL*. If the marker is on, the active marker is placed at the peak of the displayed segment.

Changing the View

The **View/Trace** key allows you to further examine the desired spectrum segment. Each of these choices selects a different part of the frequency spectrum for viewing:

Table 5-3

| | |
|--------------------------|--|
| Lower Segment | lower Tx band edge to -6 MHz offset from the channel frequency |
| Lower Adj Segment | -6 MHz to -1.8 MHz offset from the channel frequency |
| Upper Adj Segment | +1.8 MHz to +6 MHz offset from the channel frequency |
| Upper Segment | +6 MHz offset from the channel frequency to the upper Tx band edge |

EDGE Power vs. Time Measurement Concepts

Purpose

NOTE

This measurement is designed for EDGE. For GSM Power vs. Time measurements see [“GMSK Power vs. Time Measurement Concepts” on page 527.](#)

Power vs. Time measures the mean transmit power during the “useful part” of GSM bursts and verifies that the power ramp fits within the defined mask. Power vs. Time also lets you view the rise, fall, and “useful part” of the GSM burst. Using the “Multi-Slot” feature, up to eight slots in a frame can be viewed at one time.

GSM is a Time Division Multiple Access (TDMA) scheme with eight time slots, or bursts, per RF channel. If the burst does not occur at exactly the right time, or if the burst is irregular, then other adjacent timeslots can experience interference. Because of this, the industry standards specify a tight mask for the fit of the TDMA burst.

The Power vs. Time measurement provides masks for both BTS (Base Transceiver Station) and MS (mobile station). The timings are referenced to the transition from bit 13 to bit 14 of the midamble training sequence. For EDGE measurements, the 0 dB reference is determined by measuring the mean transmitted power during the middle 16 symbols of the midamble. You can also define a user configurable limit mask to apply to the measured burst using SCPI commands (refer to [“EDGE Power vs. Time Measurement Keys” on page 177.](#))

The GSM specifications defines the “useful part” of the normal GSM burst as being the 147 bits centered on the transition from bit 13 to bit 14 (the “T0” time point) of the 26 bit training sequence.

Measurement Method

The instrument acquires an EDGE signal in the time domain. The “T0” point and the useful part are computed. If Burst Sync is set to **Training Seq**, a $3\pi/8$ 8PSK demodulation is performed to find “T0”. If Burst Sync is set to **RF Amptd**, an approximation of “T0” is used without performing a demodulation. The average power in the useful part is then computed and displayed, and the EDGE limit mask is applied. The measurement displays **Pass** when the burst fits within the bounds of the mask.

Measurement Adjustments

Changing the View

The **View/Trace** key accesses a menu that allows you to select the desired view of the measurement from the following selections:

- **Burst** - views the entire burst of interest as determined by the current trigger source, burst sync, training sequence, and timeslot settings. To view a different burst of interest you must set these parameters for the selected timeslot. To view multiple slots use the **Multi-Slot** key described below. See [Figure 2-2, “EDGE Power vs. Time Result - Burst View”](#) on page 53.
- **Rise & Fall** - zooms in on the rising and falling portions of the burst being tested. See [Figure 2-3, “EDGE Power vs. Time Result - Rise & Fall View”](#) on page 53.

NOTE

The limit test is still performed on the entire burst (viewed using the **Burst** menu) when **Rise & Fall** is selected.

- **Multi-Slot** - views the entire sweep as specified by the current **Meas Time** setting. Power levels for each active slot are listed in a table below the timeslot display. Also shown in the table under **1st Error Pt.** is the point in time at which the signal level first exceeds the limit, which helps to identify the slot where a failure first occurs. See [Figure 2-4, “EDGE Result - Multi-Slot View”](#) on page 54.

Use the **Meas Time** key located in the **Meas Setup** menu to select up to eight slots. Use the **Timeslot** and **TSC** keys in the **Frequency/Channel** menu to select the slot you wish to activate. Setting **Timeslot** to **ON** and selecting a specific slot results in activating a measurement of that slot only (**Timeslot On** can be used to isolate a failure to a specific slot). When **Timeslot** is set to **OFF**, all active slots are tested against the mask.

Using a signal generator you can synchronize the multi-slot view so the frame (or portion of the frame) you are viewing starts with the slot you have selected. See [“Making Multi-Slot Measurements”](#) on page 529.

You can switch from the multi-slot view directly to the burst or rise and fall views of the slot that is currently active. The **Scale/Div** key under the **Span/Y Scale** menu can be used to enlarge your view of this signal.

Changing the Display

The **Display** key allows you to turn the limit mask on and off. This also disables the mask limit test, but still calculates the power in the useful part.

EDGE EVM Measurement Concepts

Purpose

EVM (Error Vector Magnitude) is the measure of modulation quality for EDGE. Since EDGE uses $3\pi/8$ PSK modulation, the transmitter's phase, frequency, and amplitude accuracy are critical to the communications system's performance. EVM also ultimately affects range.

EDGE receivers rely on the quality of the $3\pi/8$ PSK modulation signal to achieve the expected carrier to noise ratio. A transmitter with high EVM is often still able to support phone calls during a functional test. However, it tends to create difficulty for mobiles trying to maintain service at the edge of the cell, with low signal levels, or under difficult fading and Doppler conditions.

Measurement Method

EVM is measured by calculating the difference between the actual EVM of the transmitted signal and the EVM of a theoretical, ideal signal; this theoretical signal is derived mathematically from data sampled from the transmitted signal.

The EVM measurement allows you to view error results numerically and graphically in the instrument display. The graph windows display EVM Phase Error and Mag Error. The text window displays EVM in % rms, % peak at the highest symbol number, and 90% EVM; Mag Error in % rms; Phase Error in degrees; Freq Error in Hz; Droop in dB/symbol (Droop is stated in dB across the 142 symbol burst, it also allows you to view demodulated symbols), I/Q Offset in dB, and T0 Offset in seconds.

Measurement Adjustments

Changing the View

The **View/Trace** key accesses the menu which allows you to select the desired measurement view from the following selections:

- **Polar Vector** - The measured summary data is shown in the left window and the dynamic vector trajectory of the I/Q demodulated signal is shown as a vector display in the right window. The polar vector view presents a constantly changing display. See [Figure 2-7, "EDGE EVM Result - Polar Vector View"](#) on page 58 for an example.

- **Polar Constln** - The measured summary data is shown in the left window and the dynamic constellation of the I/Q demodulated signal is shown as a polar display in the right window. See [Figure 5-1](#) on [page 545](#).

Figure 5-1 EDGE EVM Result- Polar Constln

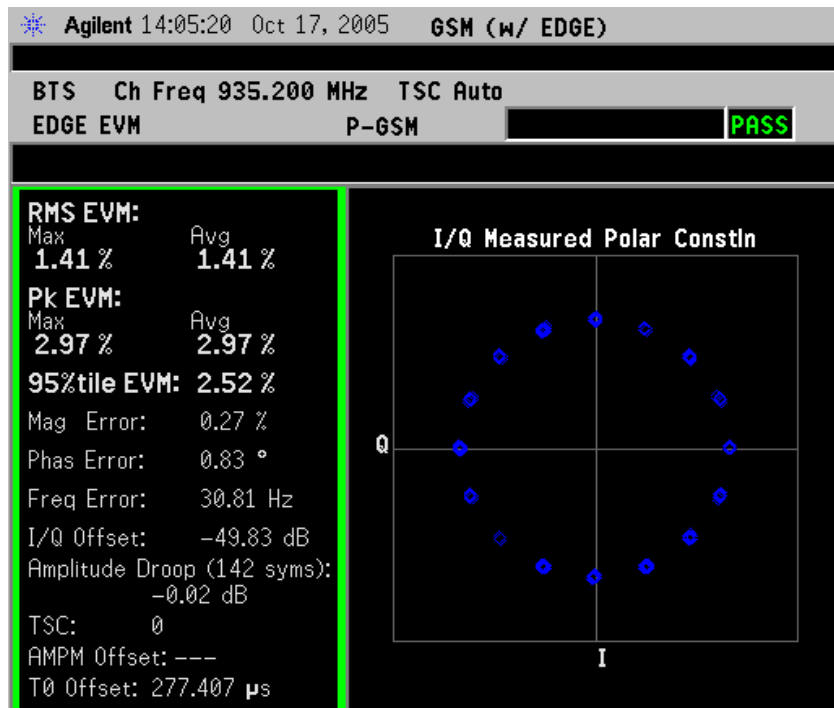

Concepts

- **I/Q Error (Quad-View)** - Four display windows show EVM, Mag Error and Phase Error graphs, and the EVM summary data text.

Figure 5-2 EDGE EVM Result - I/Q Error (Quad View)

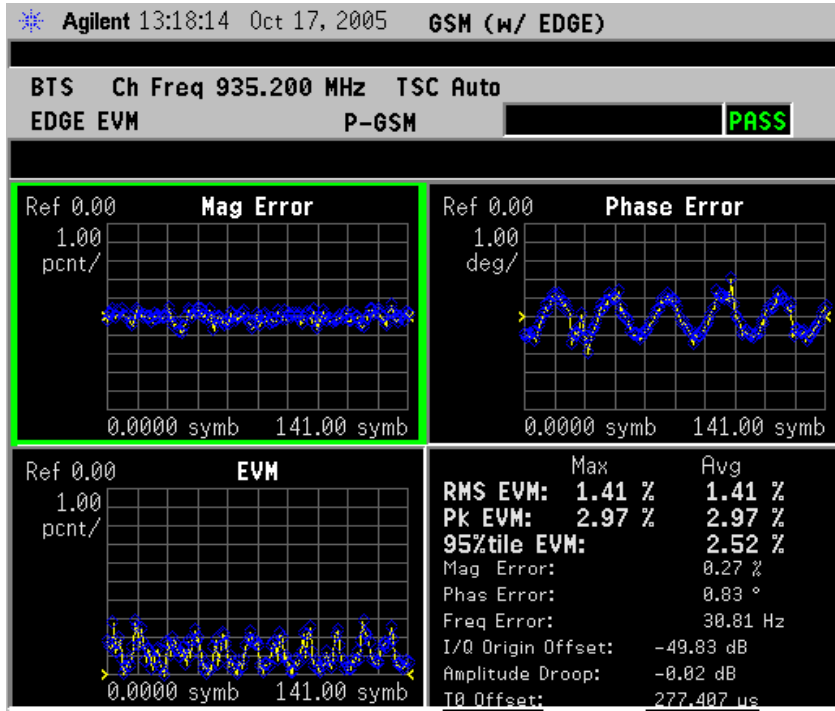

- **Data Bits** - Provides a view of the numeric results and data bits (in octal) with the sync word (TSC) highlighted. See [Figure 5-3](#).

Figure 5-3 EDGE EVM Result - Data Bits View

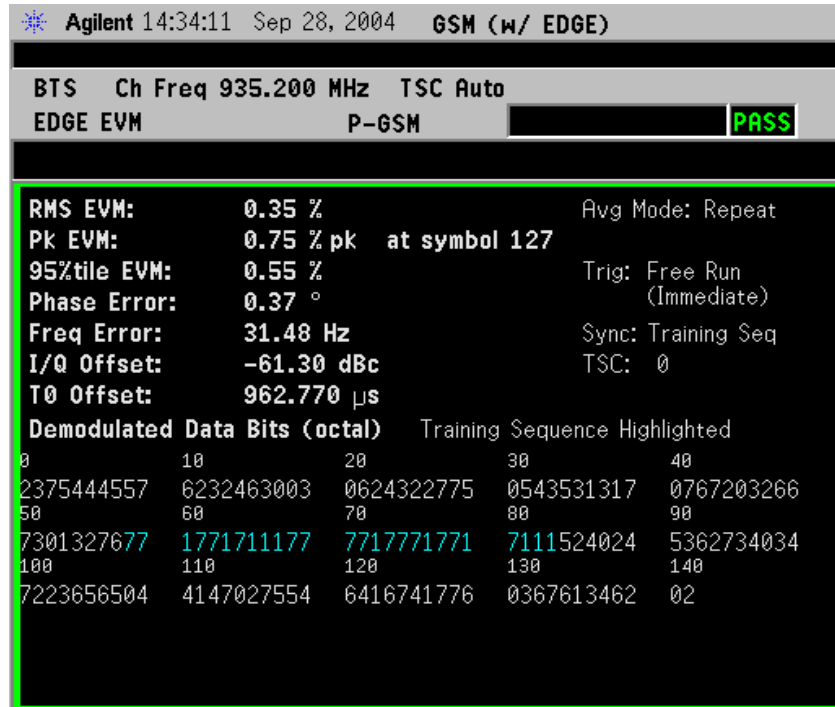

Changing the Display

The **Display** key accesses the menu to allow the following selections for changing the graph displays:

- **Symbol Dots** - Allows you to toggle the symbol dots between **On** and **Off**. The default setting is **On**.

When either EVM, Phase Error or Mag Error window is active in the I/Q Error (Quad-View) display, the **Span X Scale** key accesses the menu to allow the following selections:

- **Scale/Div** - Allows you to define the horizontal scale by changing the symbol value per division. The range is 1 to 500K symbols per division. The default setting is 14.1 symbols per division for BTS and MS device types.
- **Ref Value** - Allows you to set the symbol reference value ranging from 0 to 500K symbols. The default setting is 0.
- **Ref Position** - Allows you to set the reference position to either **Left**, **Ctr** (center) or **Right**. The default setting is **Left**.
- **Scale Coupling** - Allows you to toggle the scale coupling function between **On** and **Off**. The default setting is **On**. This function

automatically determines the scale per division and reference value by the magnitude of the measurement results.

When EVM, Phase Error, or Mag Error windows are active in the I/Q Error (Quad-View) display, the **Amplitude Y Scale** key accesses a menu which allows the following selections:

- **Scale/Div** - Allows you to define the vertical scale by changing the value per division, with units, ranges, and default values depending on which display window is active.

Mag Error Window - Units are in Percent, range is from 0.1% to 50.0%, the default is 1.00%.

Phase Error Window - Units are in degrees, range is from 0.01 degrees to 3000 degrees, the default is 1.00 degrees.

EVM Window - Units are in Percent, range is from 0.1% to 50.0%, the default is 1.00%

Since the **Scale Coupling** default is set to **On**, the value displayed in this condition is automatically determined by the measurement results.

- **Ref Value** - Allows you to set the reference value, with units, ranges, and default values depending on which display window is active.

Mag Error Window - Units are in Percent, range is from -500.0% to 500.0%, the default is 0.00%.

Phase Error Window - Units are in degrees, range is from -36000.0 degrees to 36000.0 degrees, the default is 0.00 degrees.

EVM Window - Units are in Percent, range is from -500.0% to 500.0%, the default is 0.00%.

- **Ref Position** - Allows you to set the reference position to **Top**, **Ctr** (center) or **Bot** (bottom).

Mag Error Window - The default is Ctr.

Phase Error Window - The default is Ctr.

EVM Window - The default is Top.

- **Scale Coupling** - Allows you to toggle the scale coupling function between **On** and **Off**. The default setting is **On**. This function automatically determines the scale per division and reference value by the magnitude of the measurement results.

EDGE Output RF Spectrum Measurement Concepts

NOTE This measurement is designed for EDGE. For GSM Output RF Spectrum measurement concepts see [“GMSK Output RF Spectrum Measurement Concepts”](#) on page 536.

Purpose

The Output RF Spectrum measurement is the EDGE version of the adjacent channel power (ACP) measurement. Either a single offset is measured with corresponding traces or up to 15 offsets are measured and a table is displayed. In spectrum due to modulation measurements a sweep spectrum display of -1.8 MHz to $+1.8$ MHz from the carrier can be viewed.

The output RF spectrum measurements determine the spectral energy emitted into the adjacent channels. Excessive amounts of energy spilling into an adjacent frequency channel could interfere with signals being transmitted to other MS or BTS. The measurements are divided into two main groups: spectrum due to the $3\pi/8$ 8PSK modulation and noise, and spectrum due to switching transients (burst ramping).

Since EDGE is a TDMA format, RF power is being switched on and off depending on whether the actual burst is being transmitted. The switching of power causes spectral splatter at frequencies other than that being transmitted by the carrier. Fast transitions in the time domain causes switching transients that have high frequency content associated with them.

NOTE The default output RF spectrum measurements do not perform tests at frequency offsets greater than 1800 kHz from the carrier.

Measurement Method

In this measurement, the transmitter (source) is set to transmit an EDGE frame at a given channel (frequency). The instrument acquires a time record at a particular offset from the channel being transmitted. The method of acquiring the time record is either a FFT/Inverse-FFT method, or a direct time domain (DTD) method, depending on the offset. These two methods, and when they are used, are described below. When the offset is zero, the instrument is said to be measuring the carrier. For a given offset frequency from the carrier, the transmitter must not exceed a certain power level relative to the carrier. The EDGE specification defines the offsets and their maximum absolute and relative power levels.

The general steps in making the measurement are as follows:

- Acquire time record (using either FFT or DTD methods, described below)
- Synchronize for gating on the carrier - finds 50% and 90% portion of burst for Spectrum Due to Modulation portion of the test
- Measure power of the carrier
- Compare each offset power to reference to get relative power level

The method of acquiring the time record is dependent on accuracy and dynamic range. With no pre-ADC filter, signals in the entire IF bandwidth of the instrument are digitized by the analog to digital converter (ADC). The setting of the ADC gain is based on the peak level at its input. The dynamic range (noise floor) of the ADC is dependent on the gain selected. For the type of signal being measured, the highest energy within the IF bandwidth is at the carrier. Therefore, the lowest dynamic range (highest noise floor) of the ADC occurs when the full energy of the carrier is input to the ADC.

All offsets measured using the FFT method are done with the instrument tuned such that the carrier is at the center of the IF bandwidth. Therefore, the dynamic range of the offsets measured using the FFT method is the same as that for the carrier. The dynamic range requirement generally increases as the offset frequency increases. If the dynamic range requirement exceeds what is available by FFT method, the direct time domain (DTD) method utilizing the pre-ADC filter is used.

The **Direct Time Break Freq** key setting is the first offset frequency which is measured using the DTD method. Its range is determined by assuring no aliasing occurs on FFT offsets and that the dynamic range requirements are met.

The FFT method acquires a wideband signal (1.55 MHz) in a flattop filter. An FFT is performed to get the spectrum of the GSM signal. The resolution bandwidth filter can now be applied mathematically to the spectrum at multiple offsets, with an inverse-FFT performed on the data which passes the filter. In this way, multiple offsets are acquired from one time record and LO setting. Since the resolution bandwidth filter is a mathematical formula, it can be any shape and size, and is perfect. The transmitter tester uses the 5-pole synchronously tuned filter that is specified by the GSM standard.

The primary disadvantage to the FFT method is that the acquisition must include the carrier. The high energy of the carrier causes the ADC to range down, thus lowering the dynamic range. At large offsets, the dynamic range requirement is very challenging so the direct time domain (DTD) method is used. The LO is tuned to the particular offset and the pre-ADC filter is used to reduce the carrier. This allows the ADC to range up, giving higher dynamic range. The disadvantage to

this method is that each offset measured has its own time record acquisition and LO tune position, and this causes the measurement to slow down compared to FFT offsets. The 5-pole synchronously tuned filter is approximated by utilizing a digital Gaussian filter and setting its equivalent noise bandwidth to that of the 5-pole synchronously tuned filter. For these DTD offset frequencies, the filter has closer-to-ideal 5-pole behavior (< 1% tolerance) than does a 10% tolerance, 5-pole analog filter.

Regardless of how the time record is obtained for a particular offset, the power must be measured and compared to the reference power. There are two measurements being made for the test: output RF spectrum due to modulation and the output RF spectrum due to switching transients. The GSM/EDGE standard specifies which offsets get which tests. In these two modes, the following conditions are met:

- In the output RF spectrum due to modulation measurement, the average value during at least 40 bits between bit 87 and 132 (approximately equivalent to the 50% to 90% portion of the burst, excluding midamble) is retained. The vertical lines mark the section of the burst over which the measurement is made. If multiple bursts are examined, an average of the average values is calculated. The relative power (difference between the average power of the burst at zero offset and the average power of the burst at the indicated offset) and the absolute power are displayed.
- In the output RF spectrum due to switching transients, the peak value of the whole frame is retained. The reference power of reference due to switching is the average power of the useful part of the burst with at least 300 kHz RBW. The relative power (difference between the mean transmit power of the burst at zero offset and the peak power of the burst at the indicated offset) and the absolute power are displayed.

The GSM/EDGE standard specifies the tests are run on specified offsets from the carrier. The instrument identifies this as single offset or multiple offset modes. The measurement made in these two modes is the same, except that the multiple offset mode automatically makes the measurement at all the specified offsets frequencies and lists the results in a table at the end of the measurement.

In the output RF spectrum due to modulation measurement, setting the modulation method to discrete obtains results from specified offsets from the carrier as defined in the standard; the results are displayed in a table. When set to sweep, the measurement obtains results of a span extending to 1800 kHz from both sides of the carrier, measured in 10 kHz steps; the results are displayed as a spectrum.

The EDGE ORFS Modulation view shows a single-offset (Examine) trace for an entire EDGE slot. The vertical bars show the portion used to measure power due to modulation.

Figure 5-4

EDGE ORFS Result - Modulation with Single-Offset (Examine)

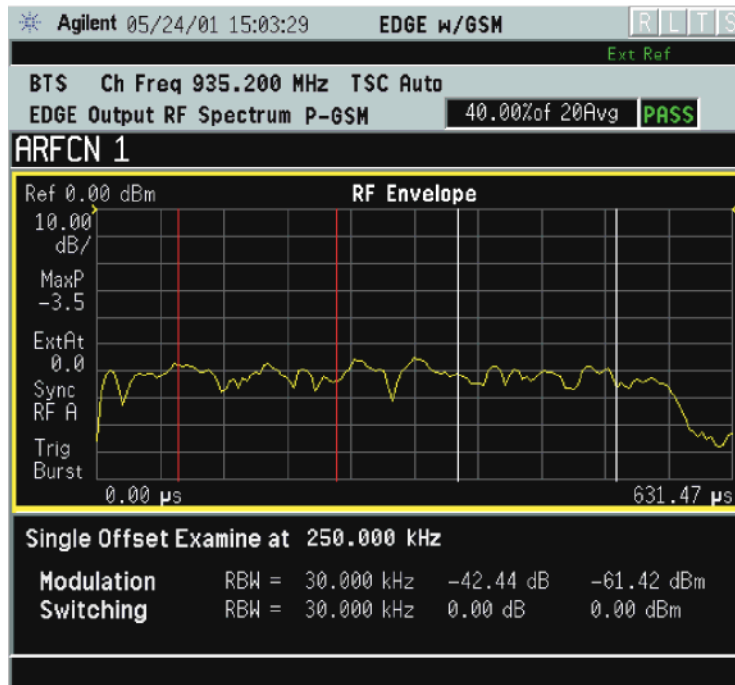
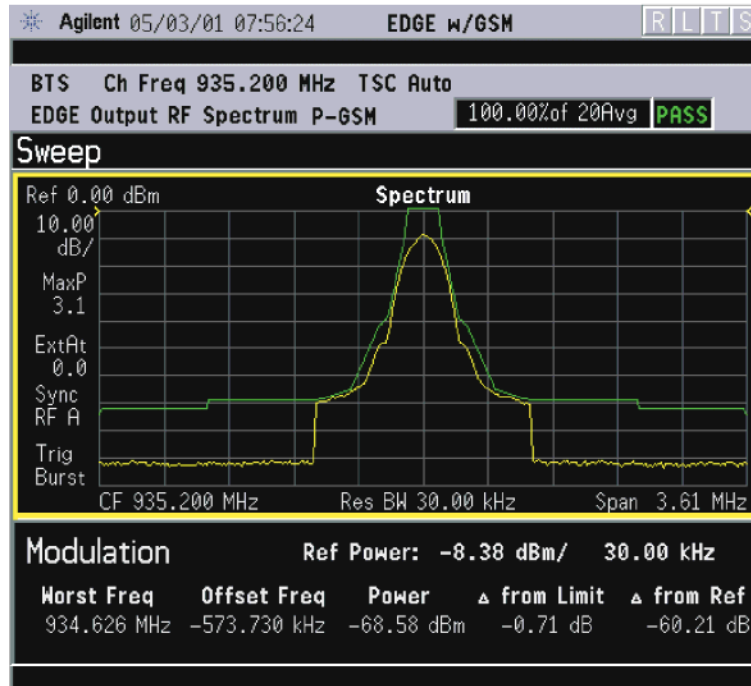

Figure 5-5

EDGE ORFS Result - Modulation Sweep Spectrum



The RF envelope trace is displayed. If averaging is turned on, the trace is then averaged with previous traces. For the modulation measurement, you may select the type of trace averaging, either log-power averaged (Video) or power averaged (RMS). For the switching

transients measurement, the peak of the traces is used. For modulation, the displayed value is the average of points within the vertical bars. For transients, the displayed value is the max of all points for all traces (Max of Peak) over the entire frame.

Measurement Adjustments

Changing the View

If the Multi-Offset measurement has been chosen and the Meas Type is Mod & Switch, pressing the **View/Trace** key allows you to select the desired view of the current measurement. If the Meas Type is Modulation, the **Switching Margin and Limit** view is unavailable. If the Meas Type is Switching, the **Modulation Margin & Limit** view is unavailable.

EDGE ORFS Measurements on a Single Bursted Slot

The PSA or E4406A can be set up to make an ORFS measurement on a single bursted EDGE slot if all of the offsets measured are less than the Direct Time Break Frequency using the following procedure:

1. Press **MODE, GSM w/EDGE**.
2. Press **MEASURE, EDGE Output RF Spectrum**.
3. Press **Meas Setup, More (1 of 2), Advanced, Direct Time Break Freq** and set the Direct Time Break frequency to be greater than the furthest offset measured. The maximum value that can be set is 775.0 kHz.
4. Press **Meas Setup, Meas Type, Modulation**.
5. Press **Meas Setup, Multi-Offset Freq List, Custom** and set the offsets to be measured.
6. Press **Trig Source** and select the trigger type appropriate for your measurement either **External Front, External Rear, or RF Burst**. If the selection is RF Burst, adjust the RF burst trigger Peak Level so that the instrument does not trigger when there is no signal present. Press **Mode Setup, Trigger, RF Burst, Peak Level**. When set properly, the instrument displays the message "Waiting for Trigger".
7. Press the **Restart** or the **Single** front-panel key or send a remote command to initiate the measurement.

EDGE Tx Band Spur Measurement Concepts

Purpose

NOTE This measurement is designed for EDGE. For GSM Tx Band Spur measurements see “GSM Tx Band Spur Measurement Concepts” on page 540.

The EDGE Tx Band Spur measurement checks that the transmitter does not transmit undesirable energy into the transmit band. This energy may cause interference for other users of the EDGE and GSM systems.

Measurement Method

This is a base station only measurement. The transmitter should be set at its maximum output power on all time slots. This measurement is performed at RF channels B (bottom), M (middle), and T (top). Refer to the following table.

| Band | Tx Band Edge (MHz) | | BOTTOM | | MIDDLE | | TOP | |
|----------|--------------------|------|-------------|--------|-------------|--------|-------------|--------|
| | Low | High | Freq (MHz) | ARFC N | Freq (MHz) | ARFC N | Freq (MHz) | ARFC N |
| P-GSM | 935 | 960 | 935.20 0 | 1 | 947.60 0 | 63 | 959.80 0 | 124 |
| E-GSM | 925 | 960 | 925.20 0 | 975 | 942.60 0 | 38 | 959.80 0 | 124 |
| R-GSM | 921 | 960 | 921.20 0 | 955 | 940.60 0 | 28 | 959.80 0 | 124 |
| DCS 1800 | 1805 | 1880 | 1805.2 0 | 512 | 1842.6 0 | 699 | 1879.8 0 | 885 |
| PCS 1900 | 1930 | 1990 | 1930.2 0 | 512 | 1960.0 0 | 661 | 1989.8 0 | 810 |

The transmit band spectrum is measured in several frequency segments using resolution bandwidths as specified by the standard (see the list below).

Table 5-4

| Frequency Offset | Resolution Bandwidth |
|--|----------------------|
| ≥ 1.8 MHz and < 6 MHz and inside Tx band | 30 kHz |
| ≥ 6 MHz and inside Tx band | 100 kHz |

The mean transmit power is measured first using the “power-above-threshold” method and the threshold is set to -20 dB (see the Transmit Power measurement for detail), and then used as a reference for the measurement limit lines if limits are used. The spectrums, which are below or above the carrier frequency and within the transmit band, are measured.

For each spectrum segment, the measurement looks for the spectrum peak closest to the limit and saves the data. The peak of all segments is reported as the *Worst Spur*. The amplitude difference from the peak to the limit line (Δ from Limit), and from the peak to the mean transmit power (Δ from Carrier) are displayed. The frequency difference from the peak to the carrier frequency (Offset Freq) is also displayed. If the peak goes above the limit line, the display indicates *FAIL*. If Marker is on, the active marker is placed at the peak of the displayed segment.

Measurement Adjustments

Changing the View

The **View/Trace** key allows you to further examine the desired spectrum segment. See “[EDGE Tx Band Spur Measurement Keys](#)” on page 184. Each of these choices selects a different part of the frequency spectrum for viewing:

| | |
|--------------------------|--|
| Lower Segment | lower Tx band edge to -6 MHz offset from the channel frequency |
| Lower Adj Segment | -6 MHz to -1.8 MHz offset from the channel frequency |
| Upper Adj Segment | +1.8 MHz to +6 MHz offset from the channel frequency |
| Upper Segment | +6 MHz offset from the channel frequency to the upper Tx band edge |

Spectrum (Frequency Domain) Measurement Concepts

NOTE

This common Spectrum concept section is used in the following PSA and VSA personalities: Basic, cdmaOne, GSM, EDGE, NADC, PDC, iDEN, cdma2000, W-CDMA, 1xEV-DO.

And the MXA SA Meas Guide.

Purpose

The spectrum measurement provides spectrum analysis capability for the instrument. The control of the measurement was designed to be familiar to those who are accustomed to using swept spectrum analyzers.

This measurement is FFT (Fast Fourier Transform) based. The FFT-specific parameters are located in the **Advanced** menu. Also available under basic mode spectrum measurements is an I/Q window, which shows the I and Q signal waveforms in parameters of voltage versus time. The advantage of having an I/Q view available while in the spectrum measurement is that it allows you to view complex components of the same signal without changing settings or measurements.

Measurement Method

The measurement uses digital signal processing to sample the input signal and convert it to the frequency domain. With the instrument tuned to a fixed center frequency, samples are digitized at a high rate, converted to I and Q components with DSP hardware, and then converted to the frequency domain with FFT software.

For E4406A Option B7C, this measurement is available for both the RF input and baseband I/Q inputs. For details on Baseband I/Q operation see the section on [“Using Option B7C Baseband I/Q Inputs”](#).

Troubleshooting Hints

Changes made by the user to advanced spectrum settings, particularly to ADC range settings, can inadvertently result in spectrum measurements that are invalid and cause error messages to appear. Care needs to be taken when using advanced features.

Waveform (Time Domain) Measurement Concepts

NOTE

This Waveform common concept section is used in the following PSA and VSA personalities: Basic, cdmaOne, GSM, GSM w/ EDGE, NADC, PDC, cdma2000, and W-CDMA, 1xEV-DO.

And the MXA SA Meas Guide.

Purpose

The waveform measurement is a generic measurement for viewing the input signal waveforms in the time domain. This measurement is how the instrument performs the zero span functionality found in traditional spectrum analyzers.

Basic mode waveform measurement data may be displayed using either a Signal Envelope window, or an I/Q window which shows the I and Q signal waveforms in parameters of voltage versus time. The advantage of having an I/Q view available while making a waveform measurement is that it allows you to view complex components of the same signal without changing settings or measurements.

The waveform measurement can be used to perform general purpose power measurements in the time domain with excellent accuracy.

Measurement Method

The instrument makes repeated power measurements at a set frequency, similar to the way a swept-tuned spectrum analyzer makes zero span measurements. The input analog signal is converted to a digital signal, which then is processed into a representation of a waveform measurement. The measurement relies on a high rate of sampling to create an accurate representation of a time domain signal.

For E4406A with Option B7C, this measurement is available for use with both the RF input and baseband I/Q inputs. For details on Baseband I/Q operation see the section on “Using Option B7C Baseband I/Q Inputs”.

Baseband I/Q Inputs (Option B7C) Measurement Concepts

The E4406A VSA Option B7C Baseband I/Q Inputs provides the ability to analyze baseband I/Q signal characteristics of mobile and base station transmitters. This option may be used only in conjunction with the following personalities:

- Basic mode (available in all VSA Series Transmitter Testers)
- Option BAF W-CDMA Measurement Personality
- Option B78 cdma2000 Measurement Personality
- Option 202 GSM with EDGE
- Option 252 GSM to GSM with EDGE upgrade

What are Baseband I/Q Inputs?

Option B7C consists of a Baseband Input module, four 50 Ω BNC connectors, and internal cabling. The four BNC connectors are grouped into pairs at the upper left corner of the front panel. The upper two connectors labeled “I” and “Q” are the “unbalanced” inputs.

In practice, an unbalanced or “single-ended” baseband measurement of an I or Q signal is made using a probe connected to the I or Q connector. A simultaneous I/Q unbalanced single-ended measurement may be made using two probes connected to the I and Q input connectors.

If “balanced” signals are available, they may be used to make a more accurate measurement. Balanced signals are signals present in two separate conductors, are symmetrical about ground, and are opposite in polarity, or out of phase by 180 degrees.

Measurements using balanced signals can have a higher signal to noise ratio resulting in improving accuracy. Noise coupled into each conductor equally in a “common mode” to both signals may be separated from the signal. The measure of this separation is “common-mode rejection”.

To make a balanced measurement, the lower two connectors labeled “ \bar{I} ” and “ \bar{Q} ” are used in conjunction with the I and Q inputs. The terms “I-bar” and “Q-bar” may be applied to the signals, as well as the inputs themselves. Probes (customer provided) must be used to input balanced baseband I/Q signals. This may be referred to as a balanced measurement.

Balanced baseband measurements are made using the I and \bar{I} connectors for I only signal measurements, while the Q and \bar{Q} connectors are used for a Q only signal measurement. Balanced

measurements of I/Q require differential probe connections to all four input connectors. For details of probe selection and use, refer to “[Selecting Input Probes for Baseband Measurements](#)” on page 559.

What are Baseband I/Q Signals?

In transmitters, the term baseband I/Q refers to signals that are the fundamental products of individual I/Q modulators, before the I and Q component signals are combined, and before upconversion to IF or RF frequencies.

In receivers, baseband I/Q analysis may be used to test the I and Q products of I/Q demodulators, after an RF signal has been downconverted and demodulated.

Why Make Measurements at Baseband?

Baseband I/Q measurements are a valuable means of making qualitative analyses of the following operating characteristics:

- I/Q signal layer access for performing format-specific demodulation measurements (e.g. CDMA, GSM, W-CDMA):
 - Modulation accuracy – that is, I/Q plane metrics
 - rho
 - error vector magnitude; rms, peak, or 95%
 - carrier feed-through
 - frequency error
 - magnitude and phase errors
- Code-domain analysis (including code-specific metrics)
- CCDF of $I^2 + Q^2$
- Single sideband (SSB) metrics for assessing output quality
- Basic analysis of I and Q signals in isolation including: DC content, rms and peak to peak levels, CCDF of each channel

Comparisons of measurements made at baseband and RF frequencies produced by the same device are especially revealing. Once signal integrity is verified at baseband, impairments can be traced to specific stages of upconversion, amplification, or filtering by RF analysis. Likewise, impairments to signal quality that are apparent at RF frequencies may be traceable to baseband using baseband analysis.

Selecting Input Probes for Baseband Measurements

The selection of baseband measurement probe(s) and measurement

method is primarily dependent on the location of the measurement point in the circuit. The probe must sample voltages without imposing an inappropriate load on the circuit.

The following measurement methods may be used with baseband I/Q inputs:

- **50 Ω Unbalanced** - This is the measurement method of choice if single-ended or unbalanced baseband I and/or Q signals are available in 50 Ω coaxial transmission lines and are terminated in a coaxial connectors. Adapters necessary to convert to a 50 Ω BNC-type male connector must be of 50 Ω impedance.

The methods are as follows:

I only measurement using one single-ended probe connected to the I input connector (available in the Basic mode)

Q only measurement using one single-ended probe connected to the Q input connector (available in the Basic mode)

I/Q measurement using two single-ended probes connected to the I and Q input connectors

- **600 Ω Balanced** - This is the measurement method of choice if balanced baseband signals having a 600 Ω impedance are available. The methods are as follows:

I only measurement using one differential probe or two single-ended probes connected to the I and \bar{I} inputs (available in the Basic mode)

Q only measurement using one differential probe or two single-ended probes connected to the Q and \bar{Q} inputs (available in the Basic mode)

I/Q measurement using two differential probes or four single-ended probes connected to the I, Q, \bar{I} , and \bar{Q} input connectors

- **1 M Ω Unbalanced** - High input impedance is the measurement method of choice if single-ended or unbalanced baseband signals to be measured lie in a trace on a circuit board and are sensitive to loading by the probe. This is the default input connector setting.

When making 1 M Ω measurements, the reference input impedance may be adjusted. For details refer to [“I/Q Setup Key Menu” on page 260](#). The 1 M Ω unbalanced measurements may be made as follows:

I only measurement using one single-ended probe connected to the I input connector (available in the Basic mode)

Q only measurement using one single-ended probe connected to the Q input connector (available in the Basic mode)

I/Q measurement using two single-ended probes connected to the I and Q input connectors

- **1 M Ω Balanced** - High input impedance measurements may also be made if differential or balanced signals are available. The 1 M Ω balanced measurements may be made as follows:

I only measurement using one differential probe or two single-ended probes connected to the I and \bar{I} inputs (available in the Basic mode)

Q only measurement using one differential probe or two single-ended probes connected to the Q and \bar{Q} inputs (available in the Basic mode)

I/Q measurement using two differential probes or four single-ended probes connected to the I, Q, \bar{I} , and \bar{Q} input connectors

This is the measurement method of choice if differential or balanced baseband signals to be measured lie in a trace on a circuit board and are sensitive to loading by the probe. When making 1 M Ω measurements, the reference input impedance may be adjusted. For details refer to “[I/Q Setup Key Menu](#)” on page 260.

The following table lists the probes currently available from Agilent, which are suitable for use under various measurement conditions:

Table 5-5

Agilent Probes - Balanced and Unbalanced

| Probe Type | Description |
|------------------------------|---|
| Unbalanced (single-ended) | 1144A 800 MHz Active Probe ^{abc} 54701A 2.5 GHz Active Probe ^{bcd} 1145A 750 MHz 2-Channel Active Probe ^{abc} 85024A High Frequency Probe ^{be} 41800A Active Probe ^{bf} 10020A Resistive Divider Probe ^{bc} 54006A 6 GHz Passive Divider Probe ^g |
| Balanced (differential) | 1141A 200 MHz Active Differential Probe ^{abc} N1025A 1 GHz Active Differential Probe ^{bh} |

- a. Not compatible with 3-wire power interface. Needs 1142A power supply. For two channels, you need either two 1142A power supplies or one 1142A power supply and one 01144-61604 1-input, two-output adapter cable.
- b. Two probes needed to cover both I and Q inputs.
- c. Output connector is BNC-type.
- d. Not compatible with 3-wire power interface. Requires use of 1143A power supply that can power two 54701A probes.
- e. 85024A bandwidth is 300 kHz to 3 GHz. Output connector is N-type. Power is 3-wire connector (+15 V, -12.6 V, ground).
- f. 41800A bandwidth is 5 Hz to 500 MHz. Output connector is N-type. Power is 3-wire connector (+15 V, -12.6 V, ground).
- g. 54006A output connector is 3.5 mm
- h. 3.5 mm output connector, requires ± 15 V supply.

Refer to the current Agilent data sheet for each probe for specific information regarding frequency of operation and power supply requirements.

The E4406A Transmitter Tester provides one “three-wire” probe power connector on the front panel. Typically, it can energize one probe. If you plan on operating more than one probe, make sure you provide sufficient external power sources as required.

Baseband I/Q Measurement Views

Measurement result views made in the Basic mode, or by other compatible optional personalities, are available for baseband signals if they relate to the nature of the signal itself. Many measurements which relate to the characteristics baseband I and Q signals have when mixed and upconverted to signals in the RF spectrum can be made as well. However, measurements which relate to the characteristics of an

upconverted signal that lie beyond the bandwidth available to the Baseband I/Q Input circuits can not be measured (the limits are up to 5 MHz bandwidth for individual I and Q signals, and up to 10 MHz for composite I/Q signals).

Some measurement views are appropriate for use with both RF and baseband I/Q signals without any modification, while other views must be altered. Some examples of measurements with identical results views are QPSK EVM, Code Domain, and CCDF. For Spectrum measurements, identical views include the I and Q Waveform view and the I/Q Polar view. For Waveform measurements, identical views include the I/Q Waveform view, the Signal Envelope view, and the I/Q Polar view.

At RF frequencies, power measurements are conventionally displayed on a logarithmic vertical scale in dBm units, whereas measurements of baseband signals using Baseband I/Q inputs may be conveniently displayed as voltage using a linear vertical scale as well as a log scale.

Spectrum Views and 0 Hz Center Frequency

Some views must be altered to account for the fundamental difference between RF and baseband I/Q signals. For Spectrum measurements of I/Q signals this includes using a center frequency of 0 Hz for Spectrum views and the Spectrum Linear view. Occupied Bandwidth and Channel Power results are also displayed using a center frequency of 0 Hz.

The center frequency of baseband I/Q Spectrum displays is 0 Hz. Frequencies higher than 0 Hz are displayed as “positive” and those below 0 Hz are “negative”. The “negative” portion of a multi-channel baseband signal below 0 Hz corresponds to the portion of the signal that would lie below the carrier center frequency when it is upconverted, if no spectral inversion occurs. As 0 Hz is a fixed center frequency, the **FREQUENCY Channel** front-panel key has no active menu for baseband I/Q Spectrum measurements.

Waveform Views for Baseband I/Q Inputs

For Waveform measurements, two new displays are available exclusively for baseband I/Q input signals; the I and Q Waveform view, which separates the individual I and Q traces, and the I/Q Polar view. Since the horizontal axis for Waveform measurements is Time, the **FREQUENCY Channel** front-panel key has no active menu for baseband I/Q Waveform measurements. Use **Span** to change horizontal scale. A **Linear Envelope** view is also available to display baseband signals that employs linear voltage units on the vertical axis.

Waveform Signal Envelope Views of I only or Q only

To view the Signal Envelope display of I only or Q only signals, use the Waveform measurement capability in Basic Mode.

Comparing RF and Baseband I/Q Measurement Views

The following table compares the measurement views for RF inputs and baseband I/Q inputs.

Table 5-6 RF vs. Baseband I/Q Input Measurement Views by Measurement

| Measurement | Views for RF Input Measurements | Views for Baseband I/Q Inputs Measurements | Mods to RF View for Baseband I/Q Inputs |
|------------------------|--|---|--|
| Channel Power | Channel Power | Channel Power | Center Freq = 0 Hz |
| ACP | FFT, Fast Bar Graph, Spectrum | Measurement Not Available | n/a |
| Power Stat CCDF | CCDF | CCDF | none |
| Spectrum (Freq Domain) | Spectrum Spectrum Linear I and Q Waveform I/Q Polar | Spectrum Spectrum Linear I and Q Waveform I/Q Polar | Center Freq = 0 Hz (Spectrum Views) Y axis = V, dBm (Spectrum Linear) |
| Waveform (Time Domain) | Signal Envelope I/Q Waveform I/Q Polar | Signal Envelope I/Q Waveform I/Q Polar Linear Envelope I and Q Waveform | Y axis = V, dBm (Linear Envelope) |

Results screens for the above measurements unique to baseband I/Q inputs are shown in the section [“Baseband I/Q Measurement Result Examples”](#) on page 132.

Other Sources of Measurement Information

Additional measurement application information is available through your local Agilent Technologies sales and service office. The following application notes treat digital communications measurements in much greater detail than discussed in this measurement guide.

- Application Note 1298
Digital Modulation in Communications Systems - An Introduction
part number 5965-7160E
- Application Note 1312
Understanding GSM Transmitter Measurements for Base
Transceiver Stations and Mobile Stations
part number 5966-2833E

Instrument Updates at www.agilent.com

These web locations can be used to access the latest information about the instrument, including the latest firmware version.

<http://www.agilent.com/find/vsa>

<http://www.agilent.com/find/psa>

6

Menu Maps

These menu maps are in alphabetical order by the front panel key label or oval cross-reference label. You can locate detailed information about each key/function at the page number listed in the figure title for each menu.

EDGE and GSM Measurement Key Flow

The key flow diagrams, shown in a hierarchical manner on the following pages, will help you understand the overall functional relationships for the front-panel keys and the keys displayed at the extreme right side of the screen. The diagrams are:

- “MODE Selection Key Flow” on page 569
- “Mode Setup/FREQUENCY Channel Key Flow (1 of 3)” on page 570
- “Measurement Selection Key Flow” on page 573
- “Transmit Power Measurement Key Flow” on page 574
- “GMSK Power vs. Time Measurement Key Flow” on page 575
- “GMSK Phase & Frequency Error Measurement Key Flow (1 of 2)” on page 576
- “GMSK Output RF Spectrum Measurement Key Flow (1 of 2)” on page 578
- “GMSK Tx Band Spur Measurement Key Flow” on page 580
- “EDGE Power vs. Time Measurement Key Flow” on page 581
- “EDGE EVM Measurement Key Flow (1 of 2)” on page 582
- “EDGE Output RF Spectrum Measurement Key Flow (1 of 3)” on page 584
- “EDGE Tx Band Spur Measurement Key Flow” on page 587
- “Spectrum (Freq Domain) Measurement Key Flow (1 of 3)” on page 588
- “Waveform (Time Domain) Measurement Key Flow (1 of 2)” on page 591

Use these flow diagrams as follows:

- There are some basic conventions:

Meas Setup

An oval represents one of the front-panel keys.

EDGE EVM

This box represents one of the keys displayed.

<for EVM>

This represents an explanatory description on its specific key.

Avg Bursts 20 On|Off

This box shows how the key default condition is displayed. Default parameters or values are underlined wherever possible.

- Start from the upper left corner of each measurement diagram. Go to the right, and go from the top to the bottom.
- When changing a key from auto (with underline) to manual, just

press that key one time.

- When entering a numeric value of **FREQUENCY Channel**, for example, use the numeric keypad and terminate the entry with the appropriate unit selection from the softkeys displayed.
- When entering a numeric value without a unit, like **Avg Number**, use the numeric keypad and terminate the entry with the **Enter** front-panel key.
- Instead of using the numeric keypad to enter a value, it may be easier to use the RPG knob or **Up/Down** keys.

Figure 6-1 **MODE Selection Key Flow**

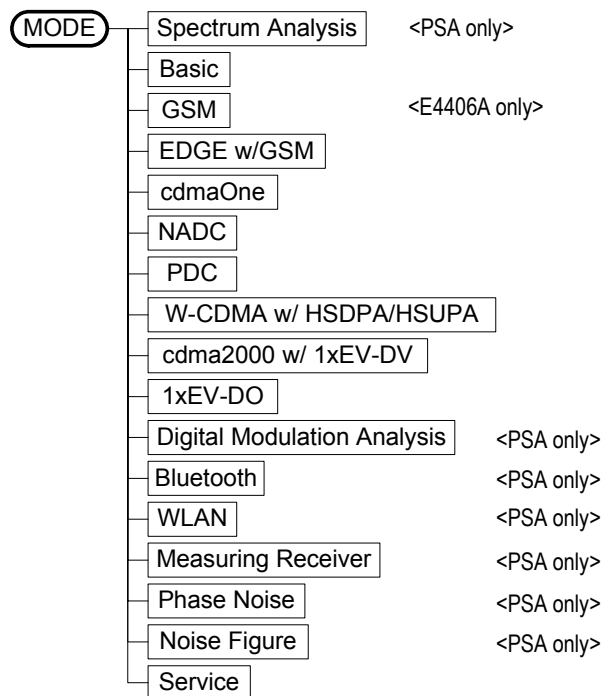

Figure 6-2 Mode Setup/FREQUENCY Channel Key Flow (1 of 3)

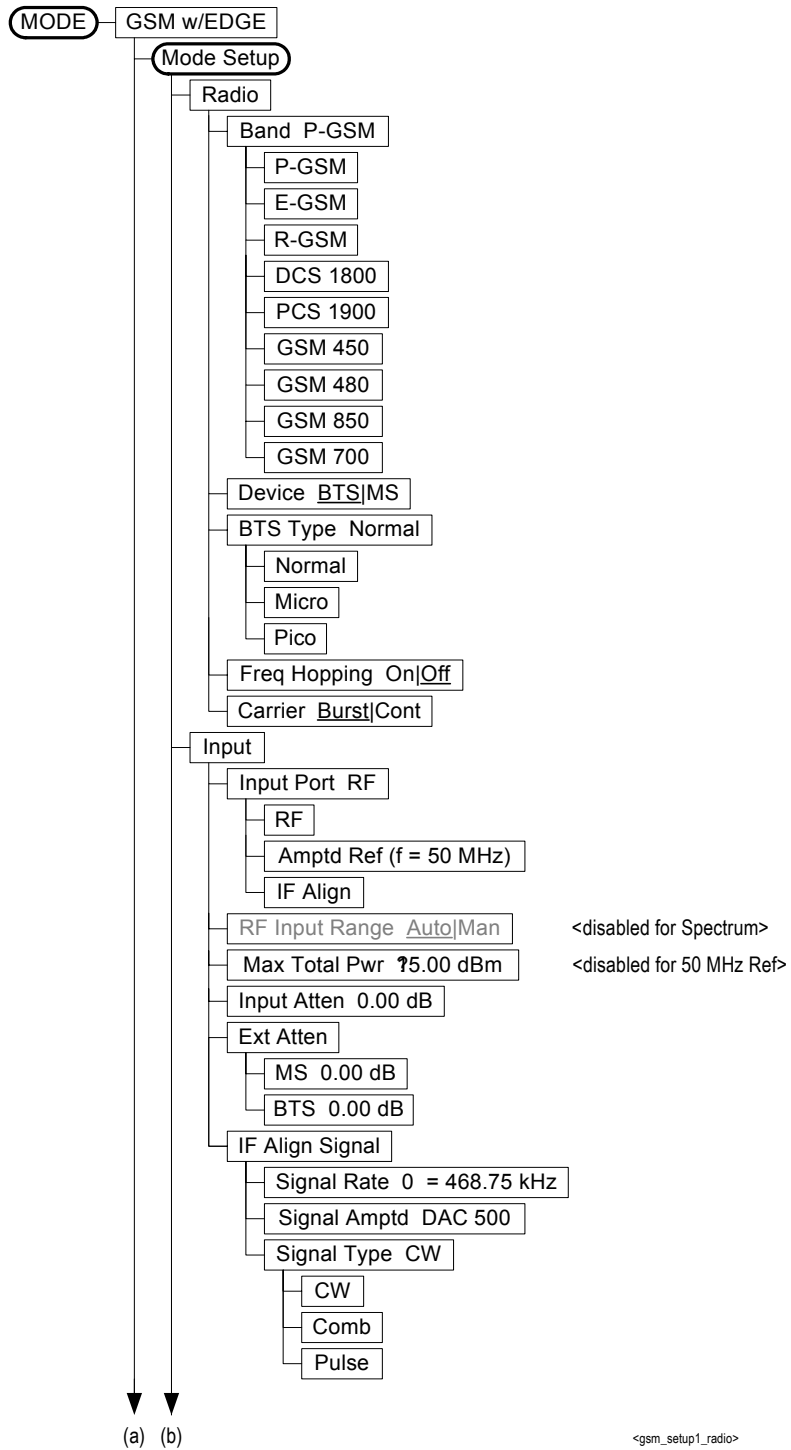

Figure 6-3 Mode Setup/FREQUENCY Channel Key Flow (2 of 3)

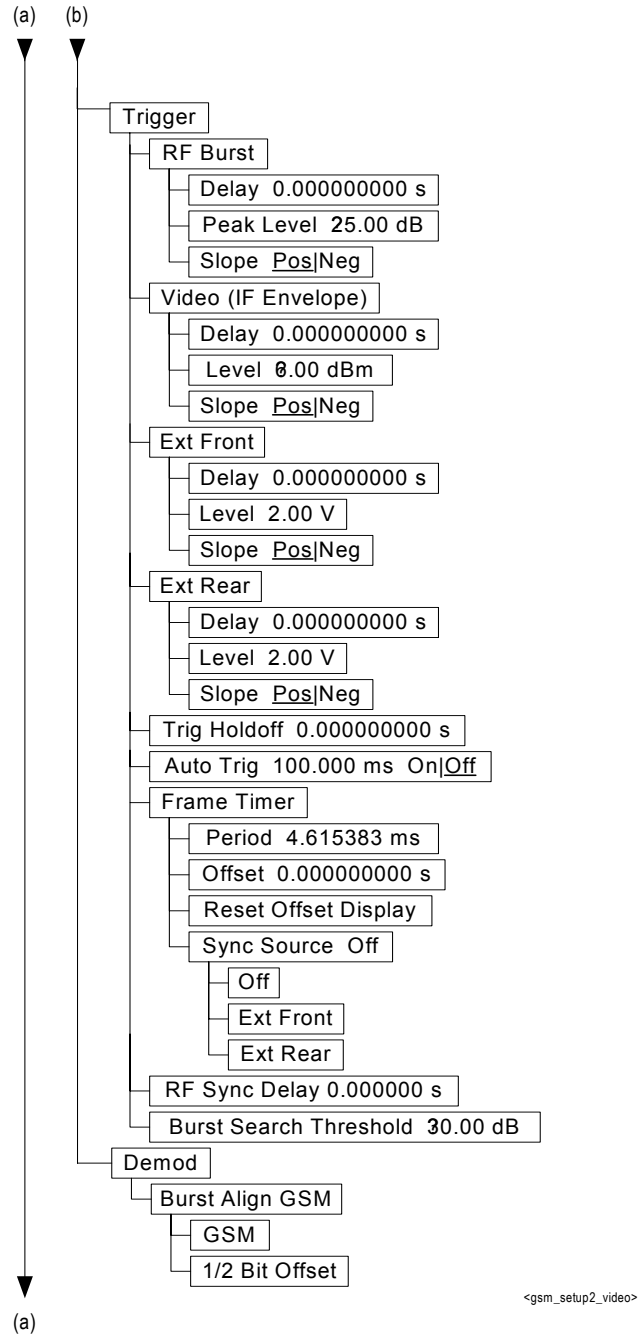

Figure 6-4 Mode Setup/FREQUENCY Channel Key Flow (3 of 3)

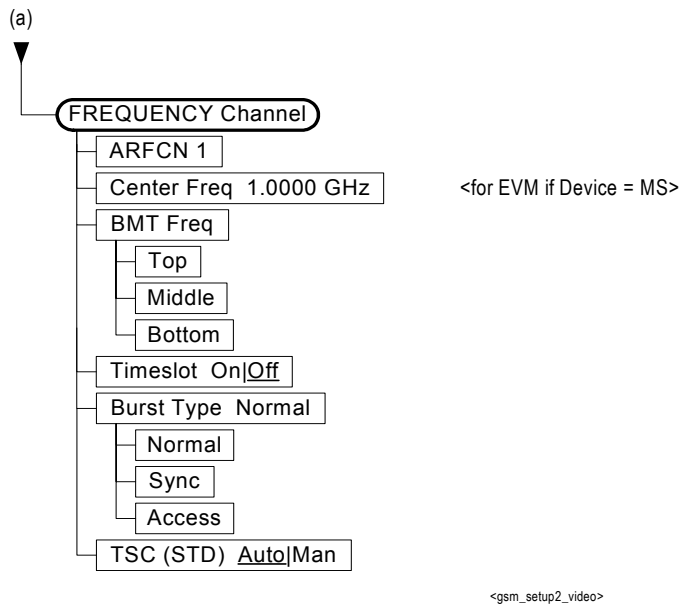

Figure 6-5 Measurement Selection Key Flow

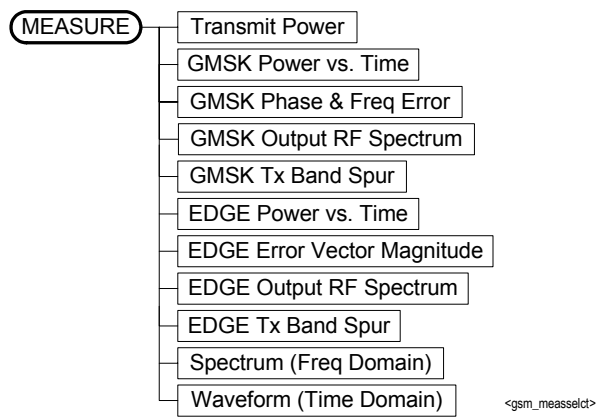

Figure 6-6 Transmit Power Measurement Key Flow

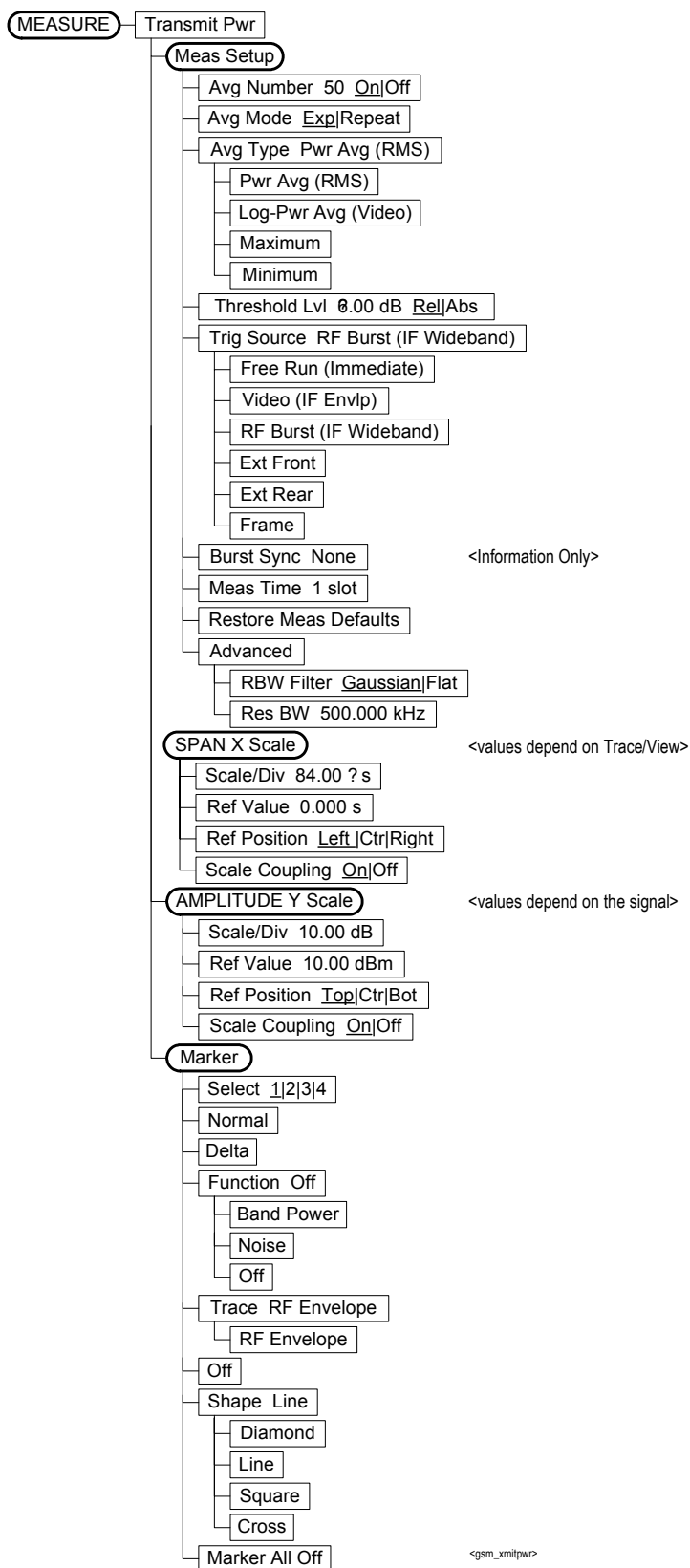

Figure 6-7 GMSK Power vs. Time Measurement Key Flow

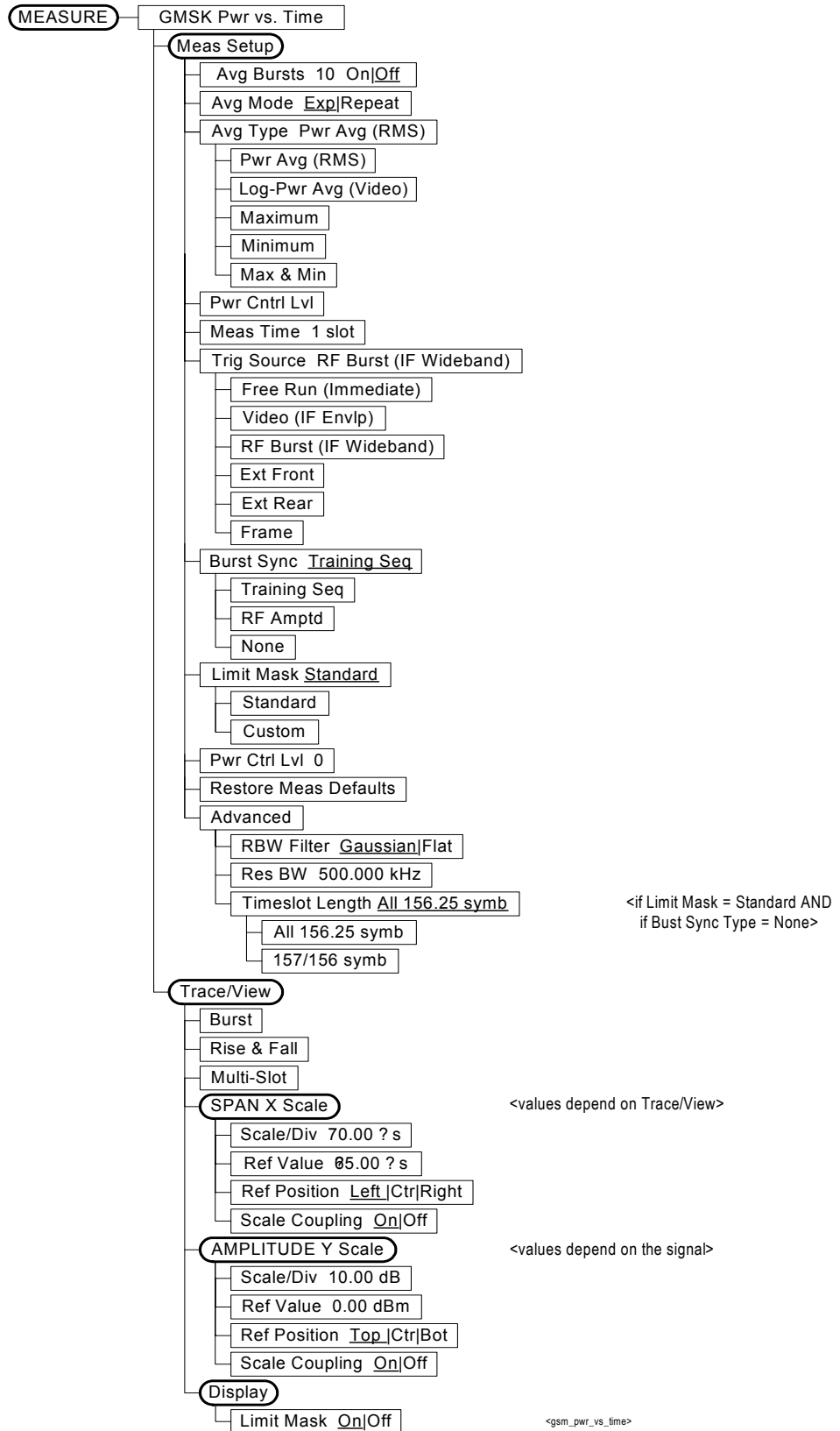

Figure 6-8 GMSK Phase & Frequency Error Measurement Key Flow (1 of 2)

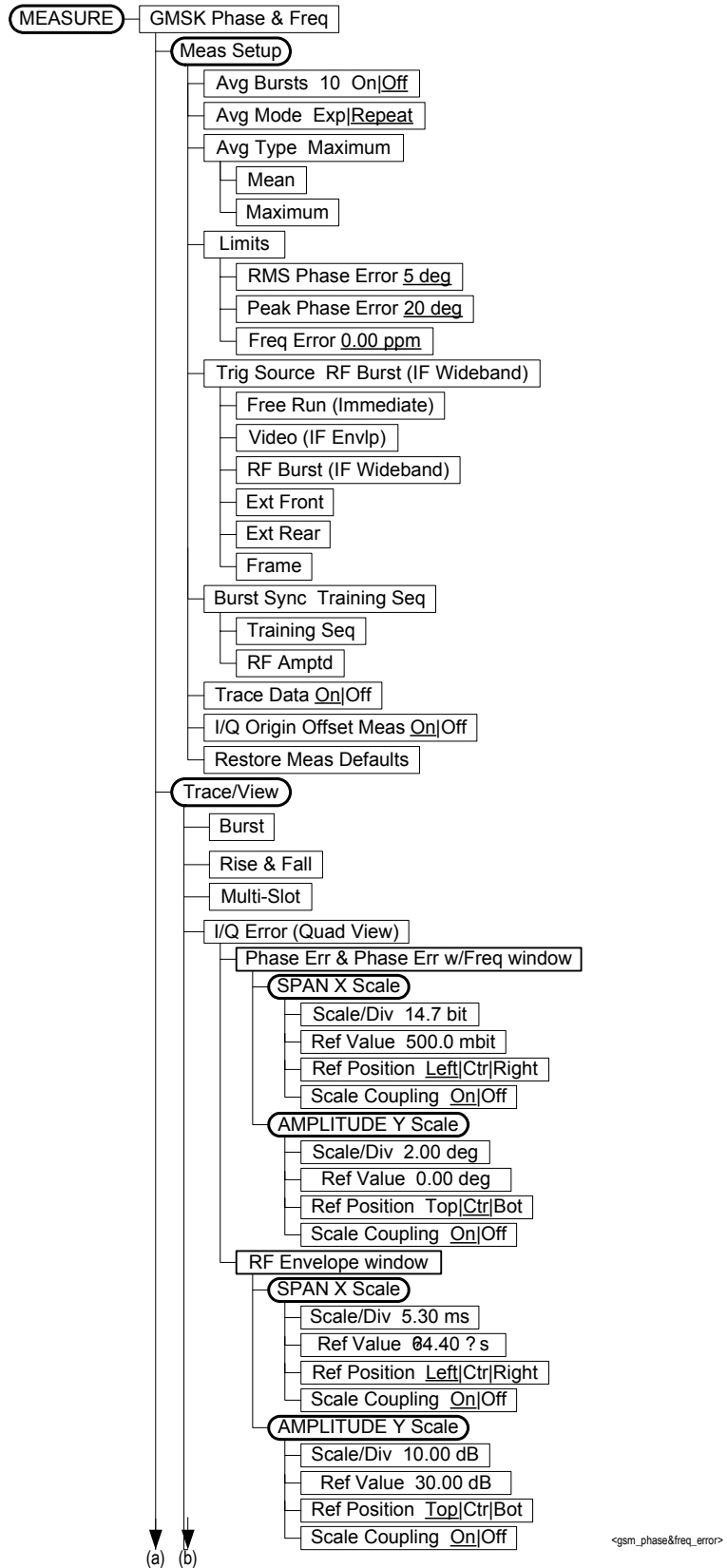
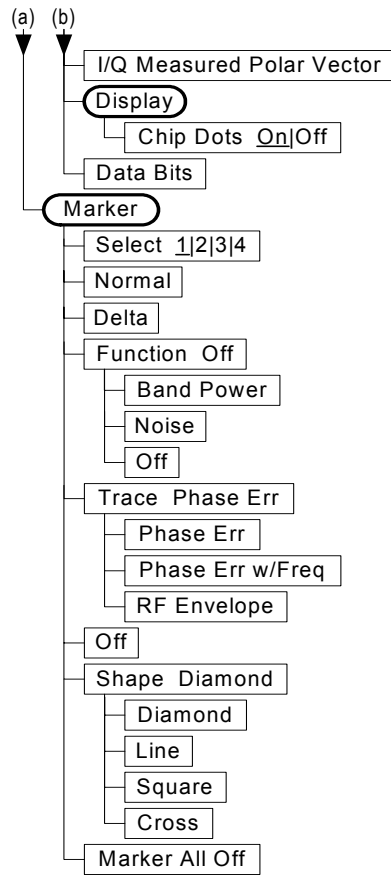

Figure 6-9 GSMK Phase & Frequency Error Measurement Key Flow (2 of 2)



<gsm_phase&freq_error2>

Figure 6-10 GMSK Output RF Spectrum Measurement Key Flow (1 of 2)

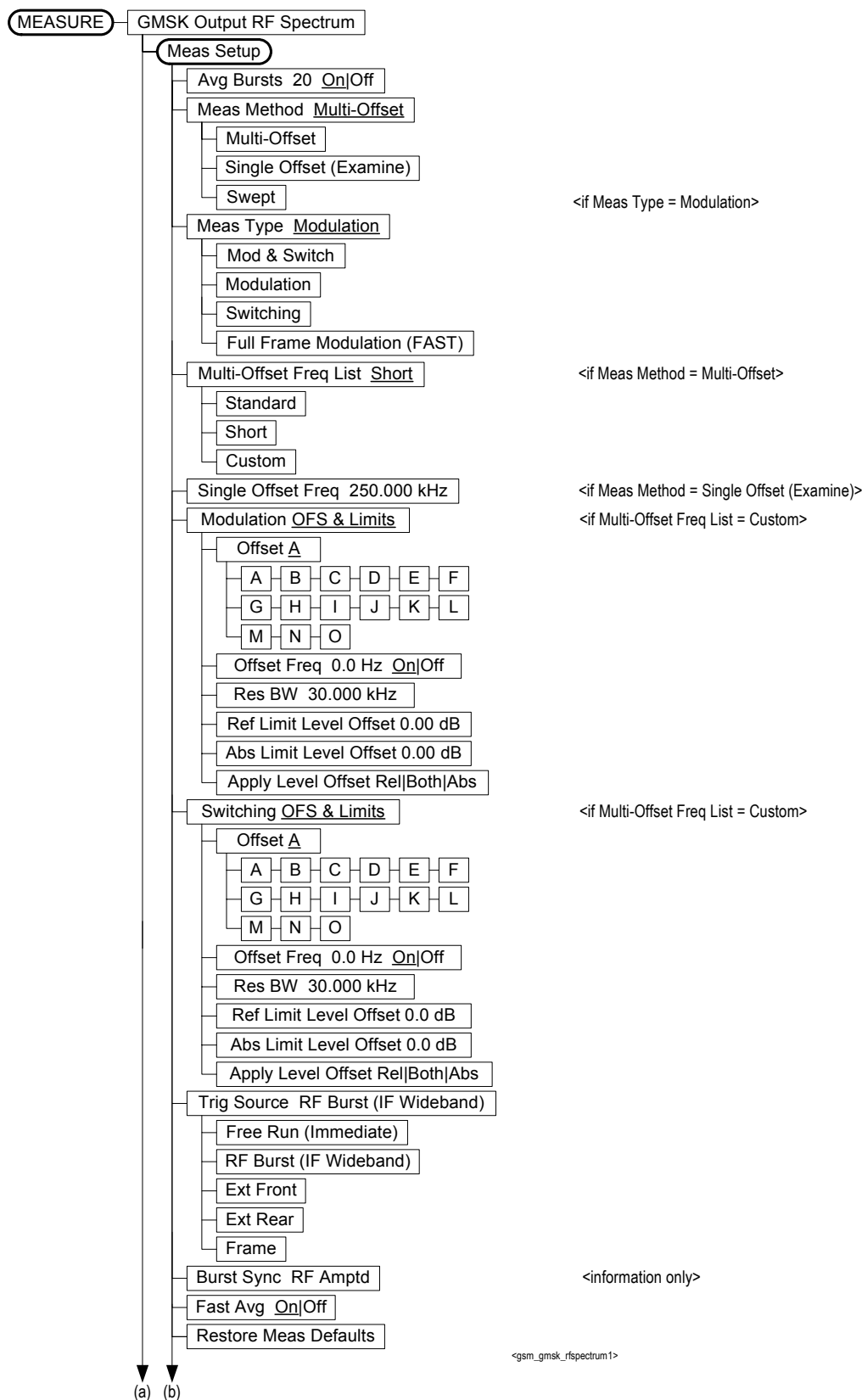
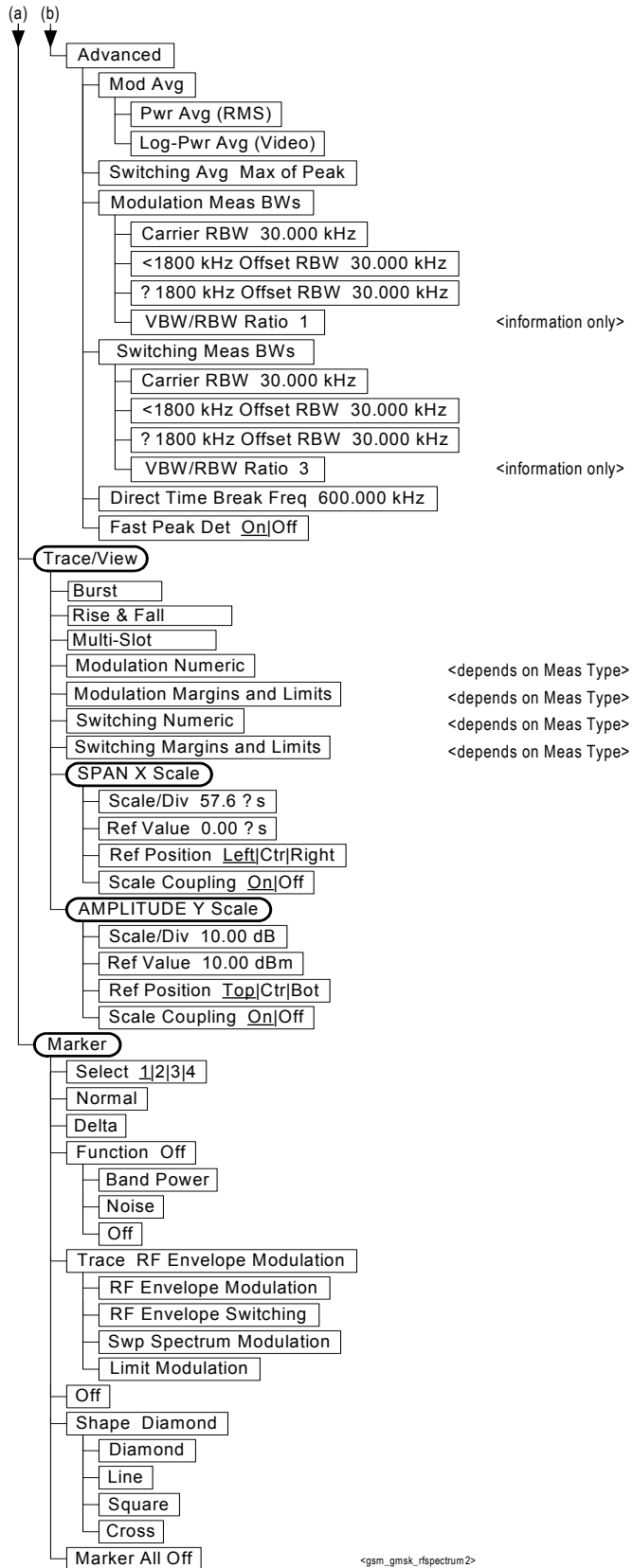

Figure 6-11 GMSK Output RF Spectrum Measurement Key Flow (2 of 2)



<gsm_gmsk_rfspectrum2>

Figure 6-12 GMSK Tx Band Spur Measurement Key Flow

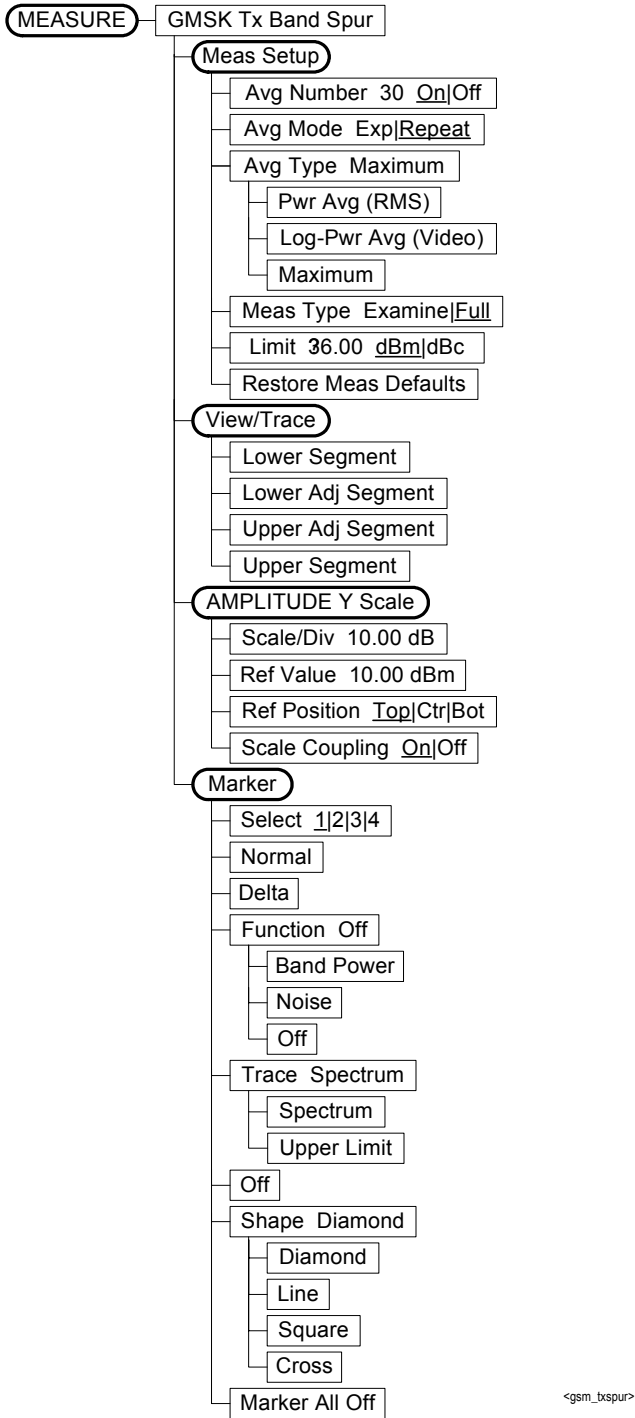

Figure 6-13 EDGE Power vs. Time Measurement Key Flow

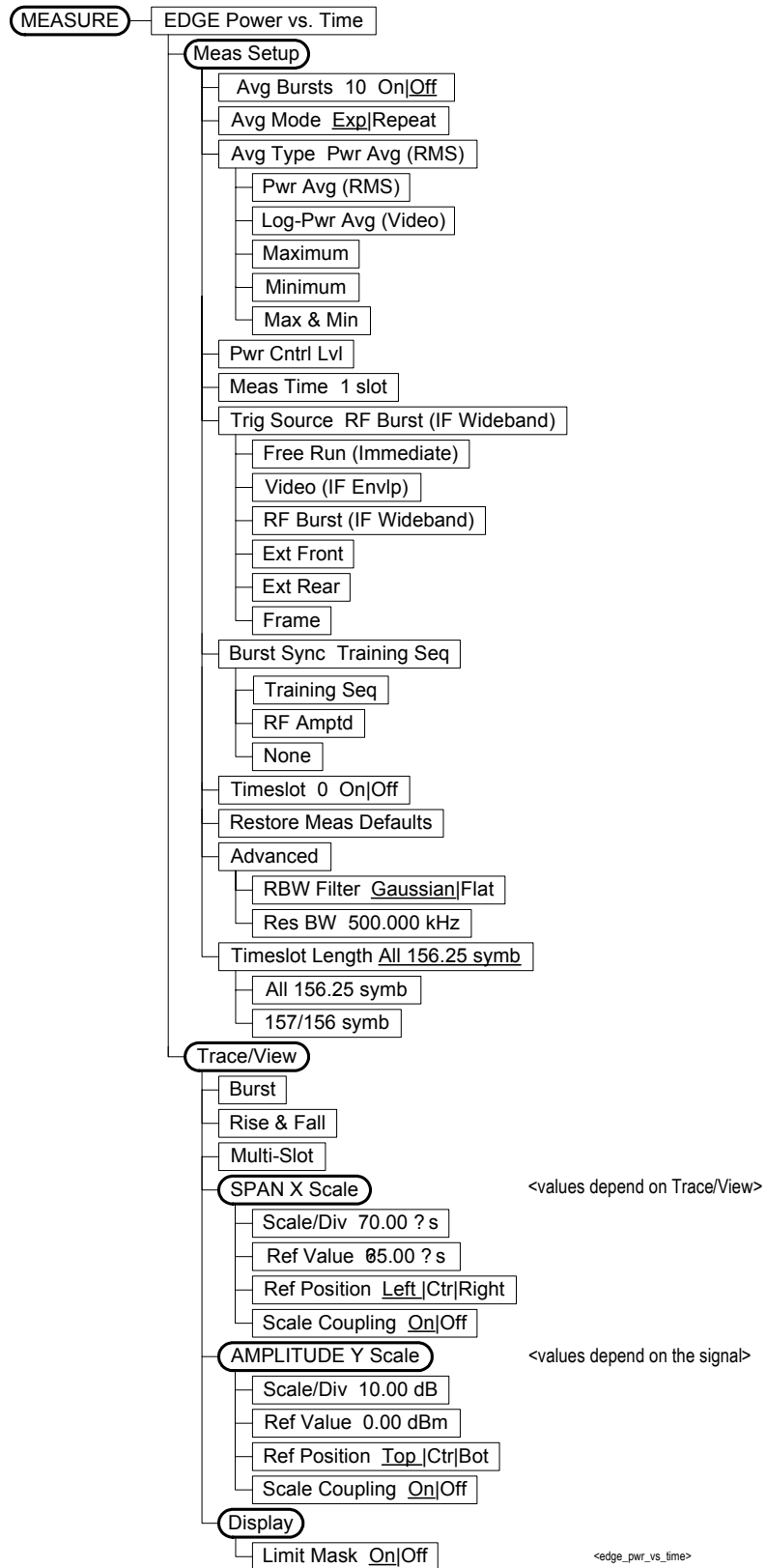
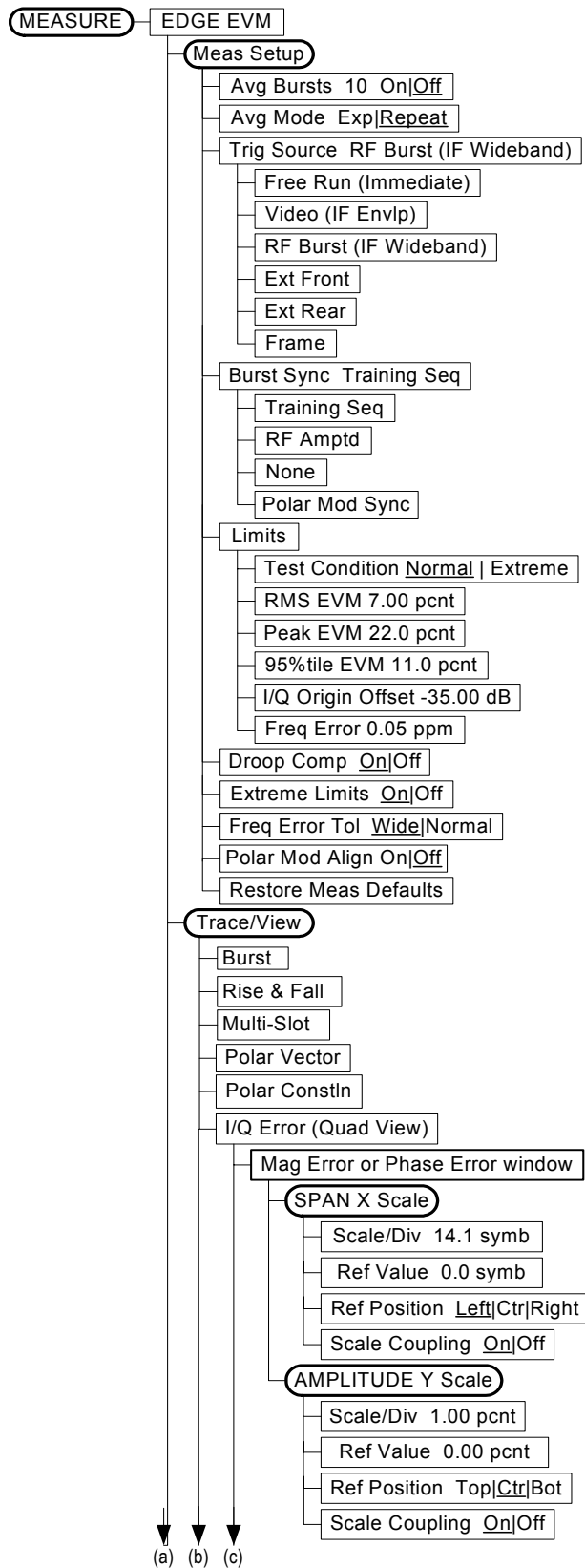

Figure 6-14 EDGE EVM Measurement Key Flow (1 of 2)



<edge_evm1>

Figure 6-15 EDGE EVM Measurement Key Flow (2 of 2)

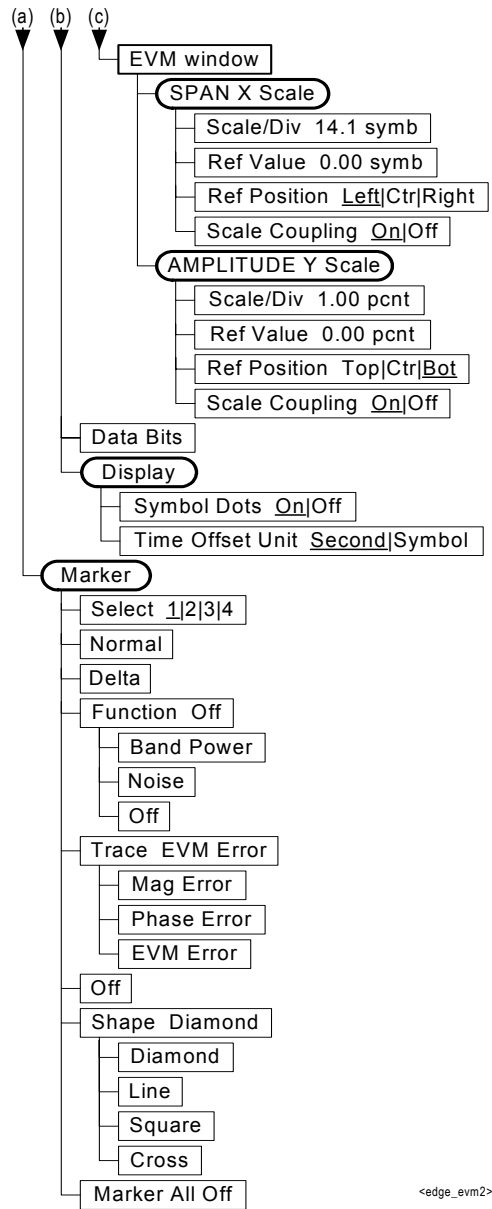

Figure 6-16 EDGE Output RF Spectrum Measurement Key Flow (1 of 3)

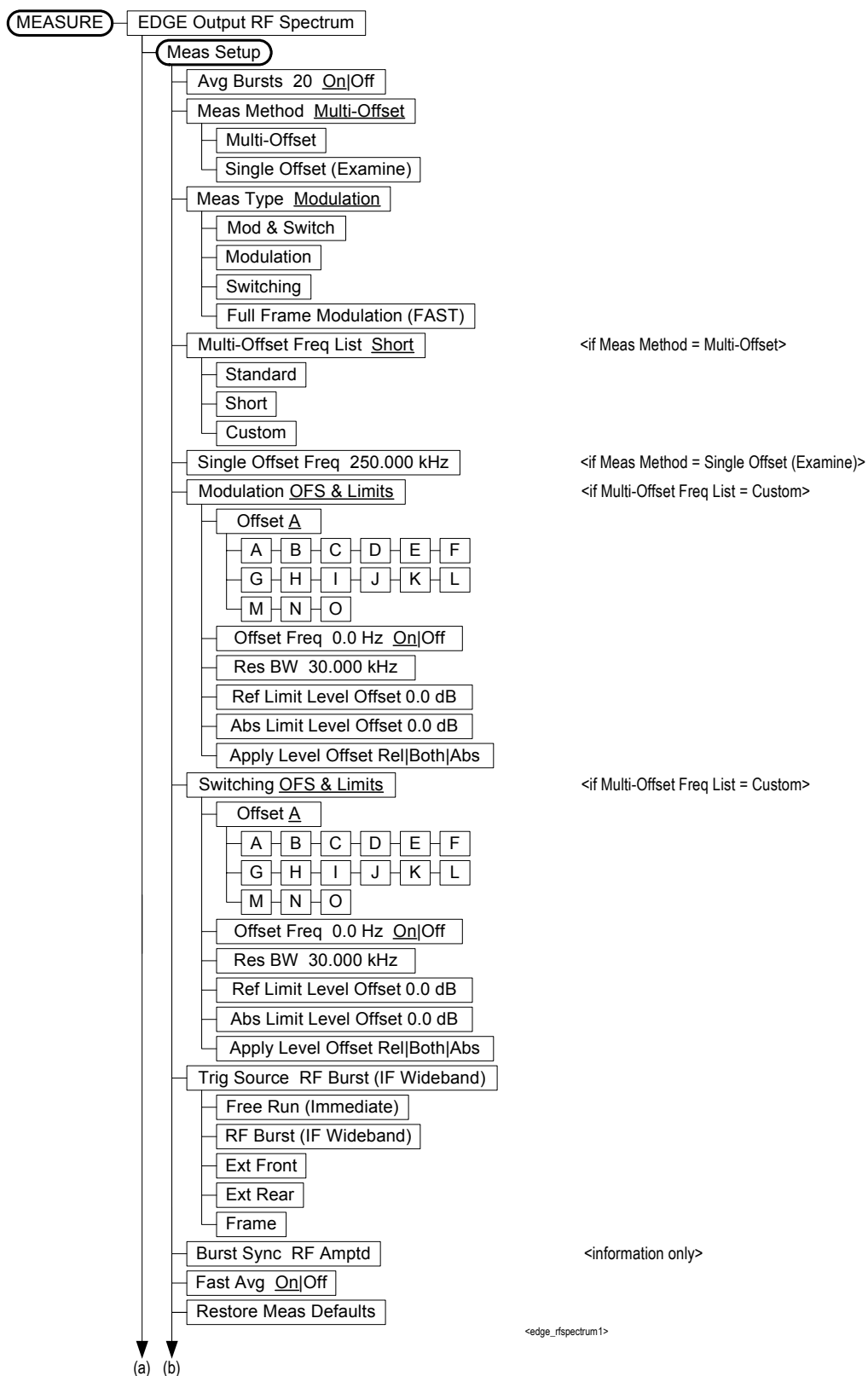

Figure 6-17 EDGE Output RF Spectrum Measurement Key Flow (2 of 3)

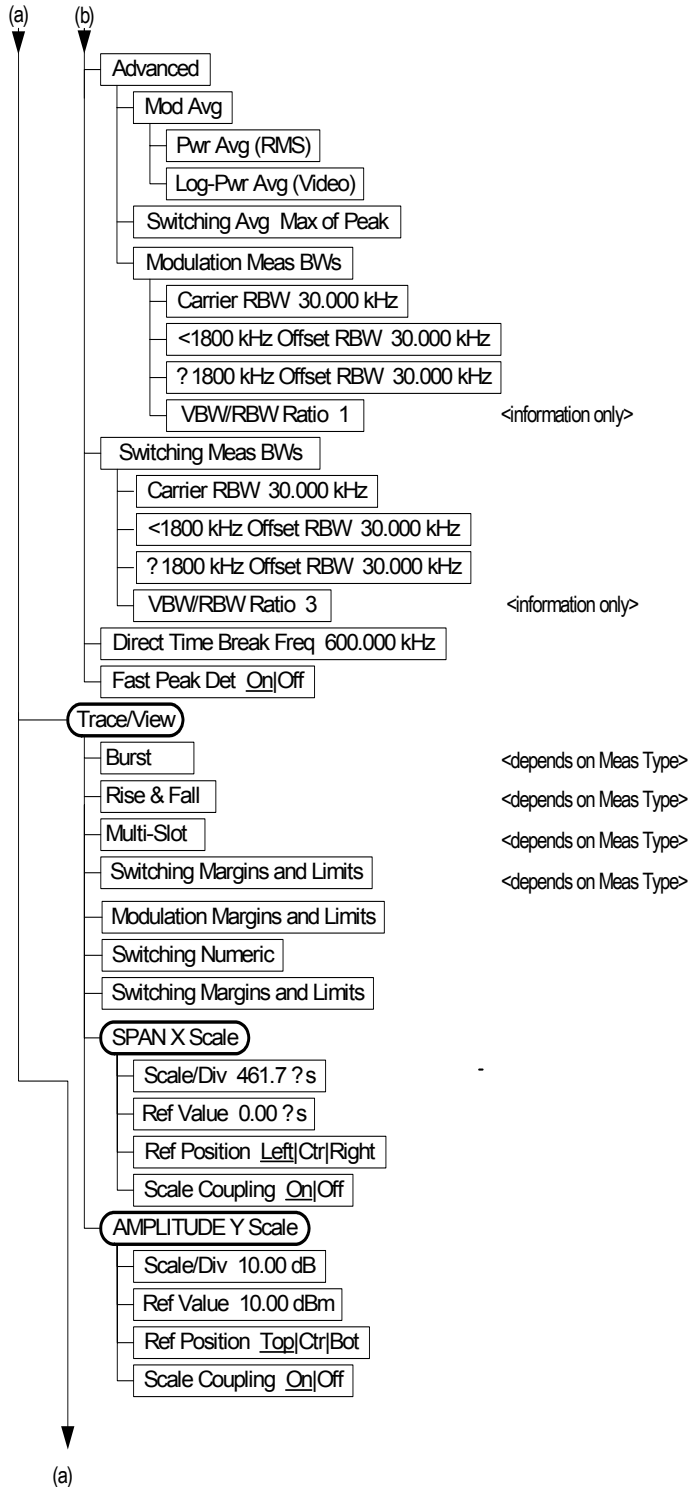

Figure 6-18 EDGE Output RF Spectrum Measurement Key Flow (3 of 3)

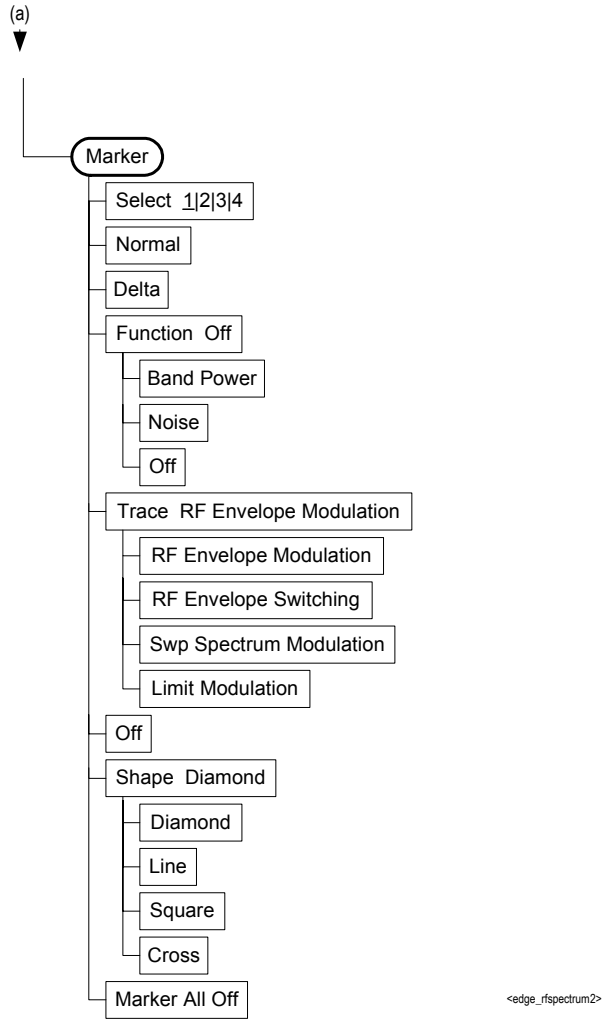

Figure 6-19 EDGE Tx Band Spur Measurement Key Flow

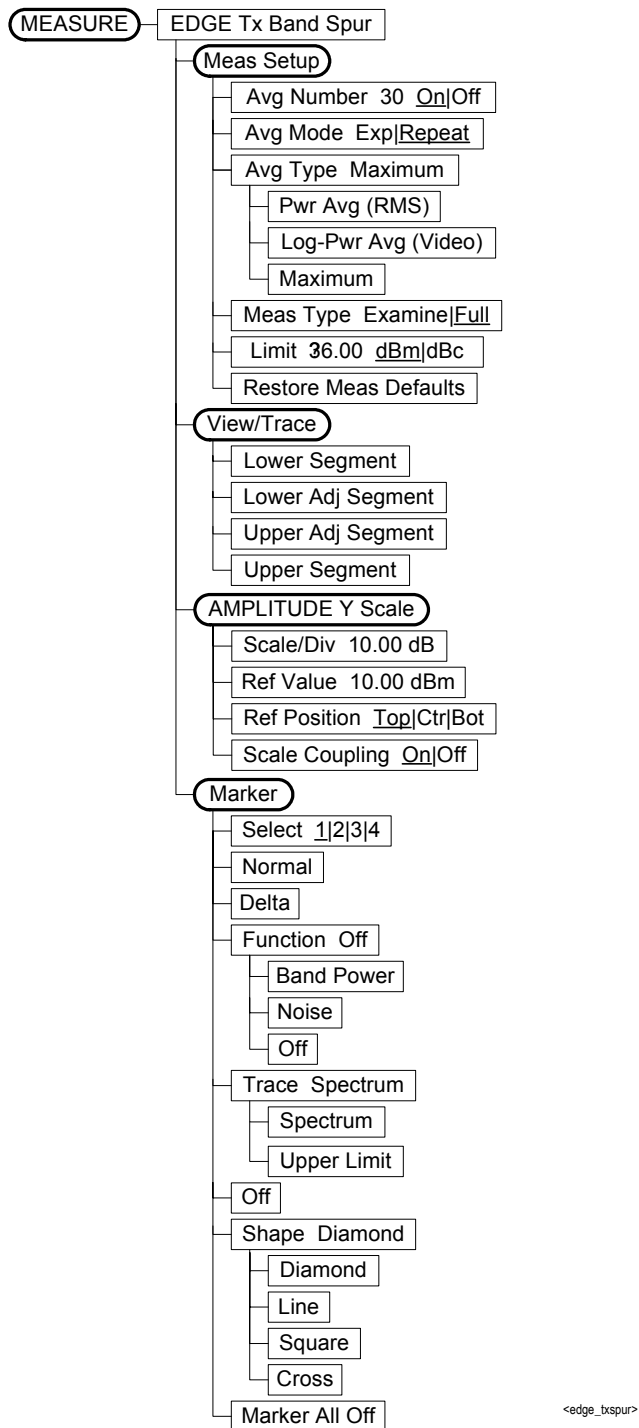

Figure 6-20 Spectrum (Freq Domain) Measurement Key Flow (1 of 3)

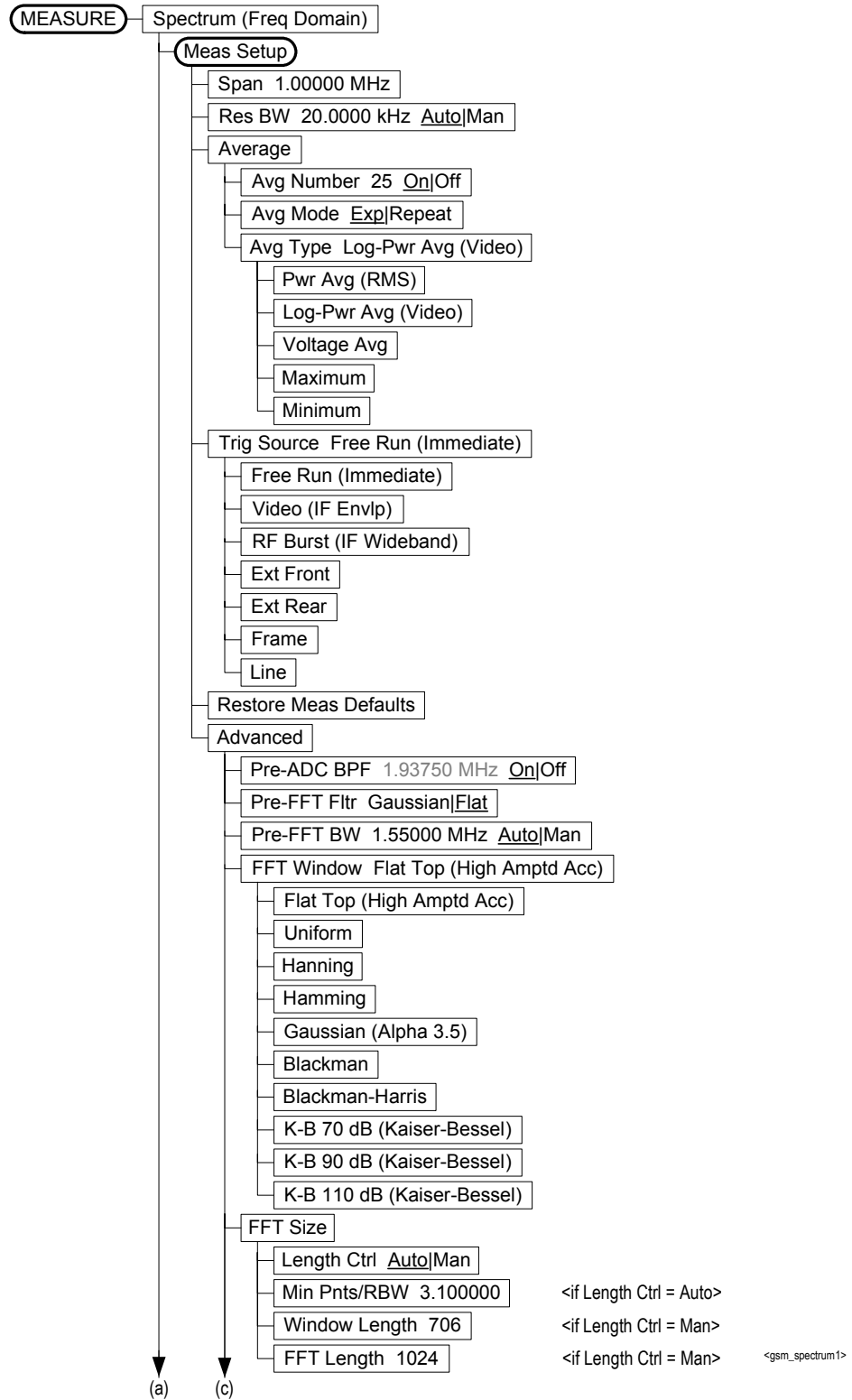

Figure 6-21 Spectrum (Freq Domain) Measurement Key Flow (2 of 3)

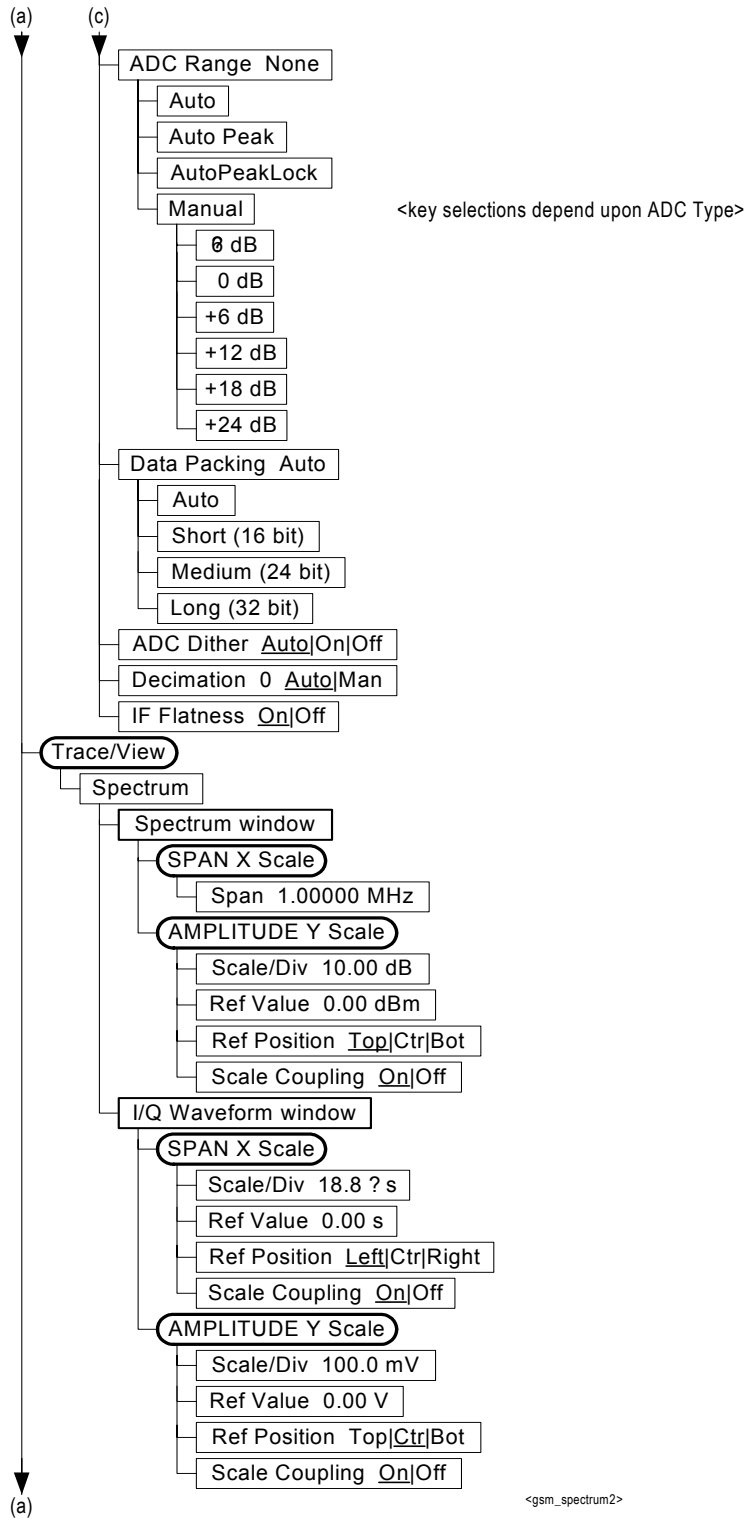

Figure 6-22 Spectrum (Freq Domain) Measurement Key Flow (3 of 3)

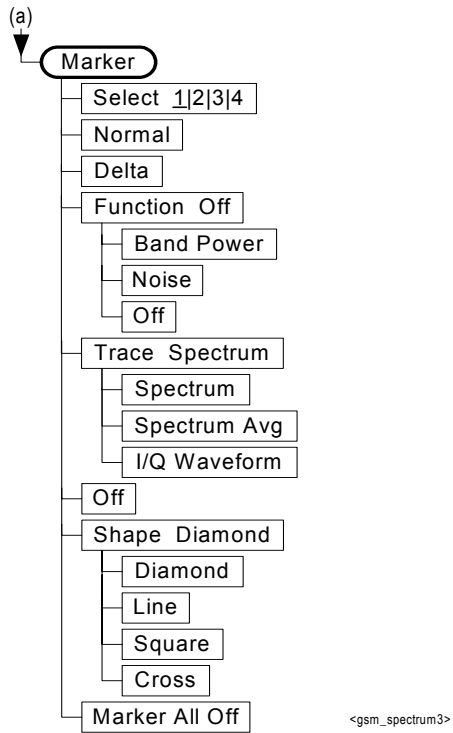
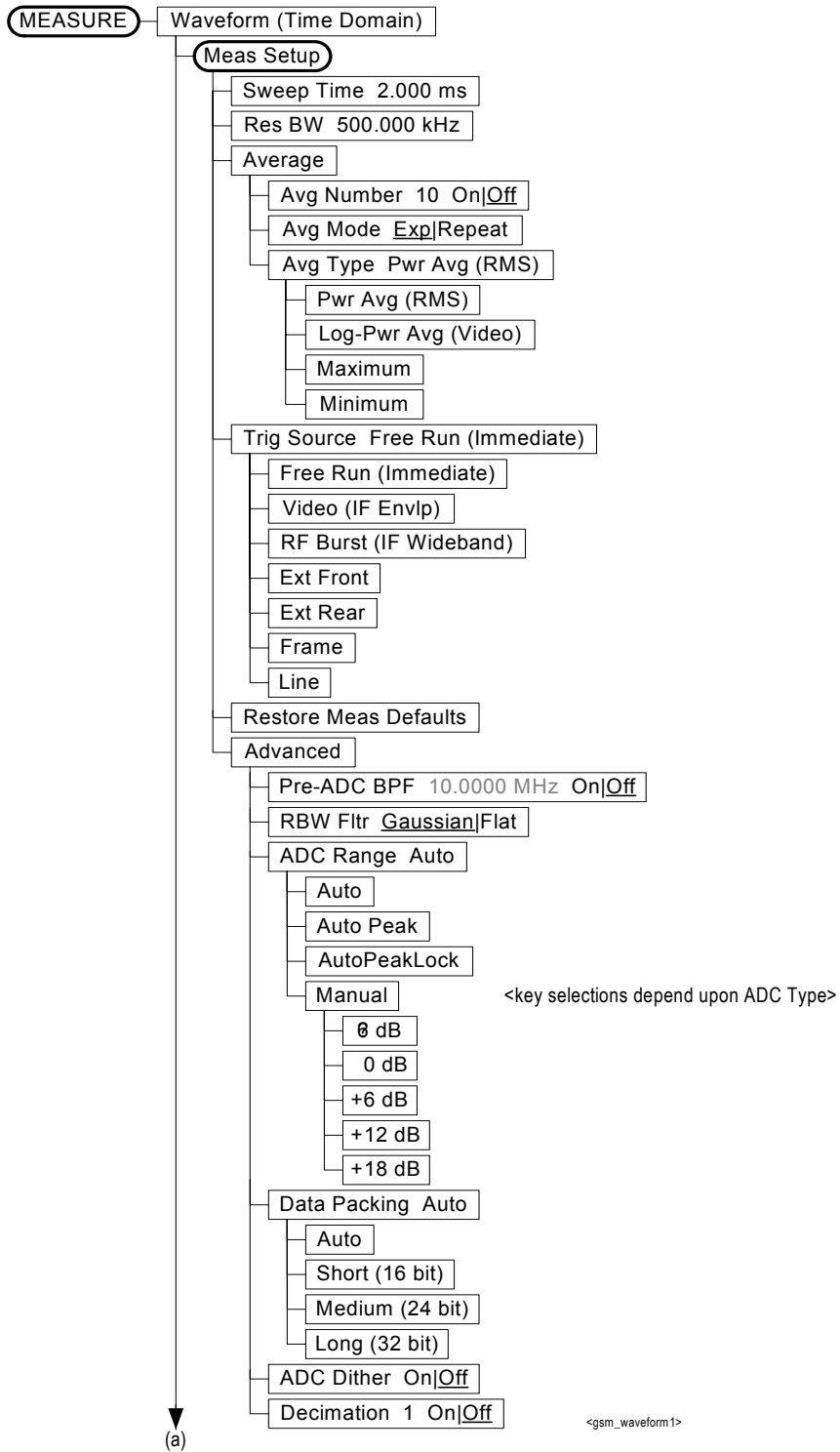
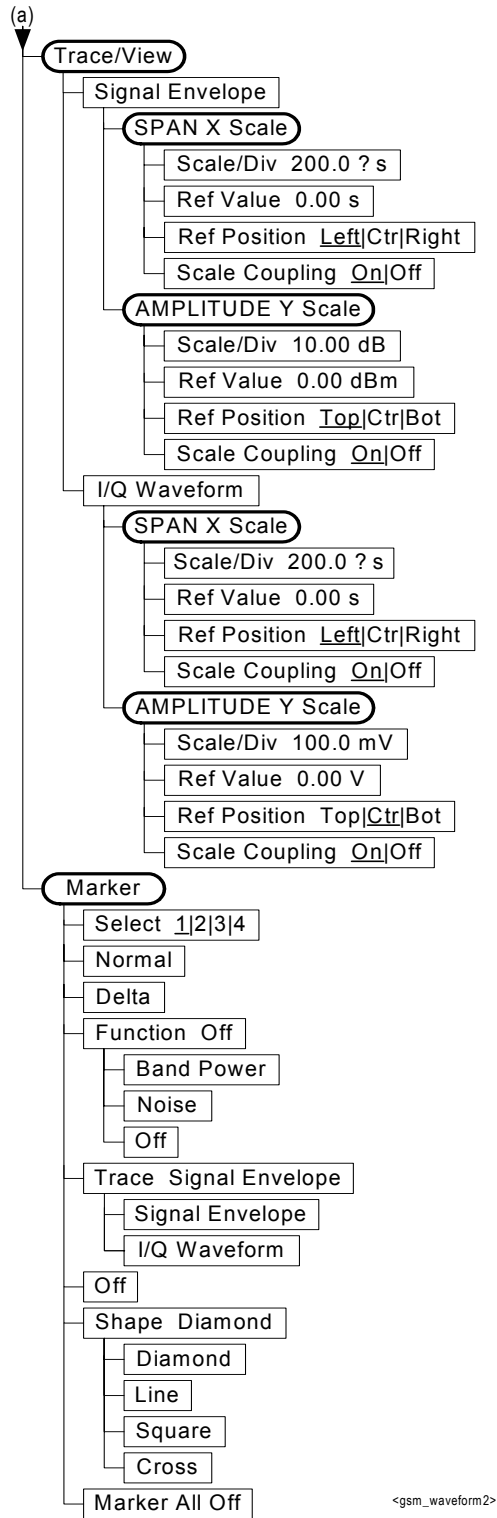

Figure 6-23 Waveform (Time Domain) Measurement Key Flow (1 of 2)



(a)

Figure 6-24 Waveform (Time Domain) Measurement Key Flow (2 of 2)



Numerics

- 1 Mohm balanced, 153
- 1 Mohm unbalanced, 153
- 50 MHz reference adjustment, 352
- 50 ohm unbalanced, 153
- 600 ohm balanced, 153

A

- ACP
 - view of data, 320
- acquisition packing
 - WAVeform, 506
- active license key, 41
 - how to locate, 41
- ADC Dither key
 - spectrum measurement, 221
- ADC dithering
 - SPECTrum, 484, 506
- ADC filter
 - WAVeform, 507
- ADC range
 - SPECTrum, 485
 - WAVeform, 507
- ADC Range key
 - spectrum measurement, 220
- ADC ranging function
 - automatic control, 242
 - automatic peak control, 242
 - automatic peak lock, 243
 - manual control, 243
- adjust timebase frequency, 381
- adjustment
 - 50 MHz reference, 352
- Advanced menu
 - spectrum, 219
- advanced menu
 - ADC dither, 243
 - ADC ranging function, 242
 - decimation, 243
 - pre-ADC bandpass filter, 242
 - resolution bandwidth filter, 242
- align 50 MHz reference, 352
- amplitude
 - input range, 460
 - maximizing input signal, 460
- ANSI standards, 525
- applications
 - currently available, 343
 - applications, selecting, 343, 345
- ARFCN definition, 525
- ARFCN setting, 390, 391, 392
- ASCII data format, 339
- attenuation
 - setting, 459
- averaging
 - CSPur, 434, 500

- EVM, 396
- ORFSpectrum, 402, 403, 439, 440
- output RF spectrum, 402, 403, 439, 440
- phase & frequency error, 455, 456
- phase and frequency error measurement, 455
- power vs. time, 419, 420, 462, 463
- SPECTrum, 486, 487
- transmit band spurs, 388, 389, 433, 458, 499, 500, 508
- transmit power, 502, 503
- WAVeform, 508, 509
- averaging state
 - power vs. time, 419, 462

B

- bandwidth
 - ORFSpectrum, 403, 405, 408, 441, 442, 444
 - output RF spectrum, 404, 405, 406, 441, 442, 443, 444
 - power vs. time, 420, 464
- PVTime, 421, 465
- SPECTrum, 490, 491
- transmit power, 503
- TXPower, 503
- WAVeform, 510, 511
- base station testing, 479
- base transmit station
 - loss correction, 395
- Baseband I/Q inputs
 - key access table, 263
 - key entries, 263
 - key path, 263
- Baseband IQ measurements, 131
- basic mode, 136
- binary data order, 339
- burst carriers, 479
- burst search threshold, 498
- burst trigger
 - level, 519
- byte order of data, 339

C

- carrier
 - type, 478, 479
- carrier selection, 478
- center frequency setting, 437
- center frequency step size, 437
- changing
 - instrument settings, 388
- channel burst type, 392
- channel number

- ARFCN, 390, 391, 392
- Choose Option key, 40
- code, programming
 - compatibility across PSA modes, 267, 269
 - compatibility, PSA series versus VSA, 270
- commands
 - compatibility across PSA modes, 267, 269
 - CONFigure, 350
 - FETCH, 350
 - INITiate, 351
 - MEASure, 349
 - PSA series versus VSA
 - compatibility, 270
 - READ, 351
- compatibility, programming
 - across PSA modes, 267
 - PSA series versus VSA, 270
- CONFigure command use, 347
- CONFigure commands, 350
- Continuous carrier GMSK Phase and Freq measurements, 534
- continuous carriers, 479
- continuous vs. single
 - measurement mode, 341
- control measurement commands, 341
- correction
 - base transmit station loss, 395
 - mobile station loss, 395
- Current Data, EDGE PvT, 52, 96, 210, 532
- current measurement, 319
- curve fit the data, 282

D

- data
 - querying, 272, 282
- data decimation, 491
 - WAVeform, 511, 512
- data format, 339
- data from measurements, 347
- Data Packing
 - spectrum measurement, 220, 243
- DCS1800, 480
- Decimation
 - spectrum measurement, 221
- decimation
 - SPECTrum, 491
- decimation of data
 - WAVeform, 511, 512
- default states, 48, 146
- default values, setting remotely, 350

Index

- deleting an
 - application/personality, 35
 - delta markers, 305
 - display
 - on/off, 320
 - PVT limits, 321, 328
 - spectrum window, 329, 330, 335, 336
 - tiling, 327
 - trace, 331
 - window tile, 327
 - zoom, 327
 - display ACP data, 320
 - display commands, 320
 - dithering the ADC, 484, 506
 - downlink
 - definition of, 525
 - Droop amplitude, EDGE EVM, 158, 544
 - Droop Compensation key, 158
 - Droop Error, EDGE EVM, 354, 356
 - Dynamic Range Not Optimum message, 153
- E**
- EDGE error vector magnitude, Meas Setup Key Menu, 156
 - EDGE EVM
 - Polar Mod Align key, 158
 - Polar Mod Sync key, 158
 - time offset unit key, 163
 - EDGE EVM, Droop amplitude, 158, 544
 - EDGE EVM, TSC (Training Sequence) Burst Sync, 159
 - EDGE EVM, Droop Error, 354, 356
 - EDGE ORFS
 - burst sync setup, 169
 - fast averaging setup, 169
 - meas method
 - multi-offset, 64, 166
 - single offset, 64
 - single offset (examine), 167
 - swept, 65, 167
 - meas type
 - Full Frame (FAST), 64, 166
 - mod & switch, 64, 166
 - modulation, 64, 166
 - switching, 64, 166
 - modulation offsets & limits
 - Abs limit level offset setup, 168, 188
 - apply level offset setup, 168, 188
 - offset freq setup, 167, 188
 - offset setup, 167, 188
 - Rel limit level offset setup, 168, 188
 - Res BW setup, 167, 188
 - modulation offsets & limits setup, 167, 188
 - multi-offset freq list, 167, 188
 - offsets & limits
 - offset freq setup, 168
 - switching offsets & limits
 - Abs limit level offset setup, 168, 189
 - apply level offset setup, 168, 189
 - offset freq setup, 168, 189
 - offset setup, 168, 189
 - Rel limit level offset setup, 168, 189
 - Res BW setup, 168, 189
 - trigger source setup, 169
 - EDGE PvT, Current Data, 52, 96, 210, 532
 - EDGE transmit band spurs measurement, 433
 - EGSM
 - RGSM
 - DCS, 480
 - error vector magnitude
 - measuring, 56, 544
 - error vector magnitude measurement, 353, 396
 - error vector measurement
 - See also EVM
 - ETSI standards, 34
 - EVM
 - averaging, 396
 - symbol dots, 398, 399, 400
 - trigger source, 400
 - EVM Limits menu, 158
 - external reference, 482
 - external trigger
 - delay, 515
 - level, 515
 - slope, 516
 - Extreme Limits menu, 158
- F**
- fast averaging
 - EDGE ORFS, 169
 - GMSK ORFS, 190
 - Fast Peak Det, EDGE mode, 171, 191
 - FETCh command use, 347
 - FETCh commands, 350
 - FFT
 - SPECTrum, 492, 493, 494, 495
 - FFT bandwidth, SPECTrum, 489, 490
 - FFT Length key, 220
 - FFT Size menu, 220
 - FFT Window key, 219
 - format, data, 339
 - frame trigger adjustment, 516, 517
 - frame trigger period, 516
 - frame trigger sync mode, 517
 - frequency
 - carrier setting, 478
 - center, 437
 - step size, 437
 - frequency offsets
 - ORFSpectrum, 411
 - output RF spectrum, 447
 - frequency span
 - SPECTrum, 495
 - Full Frame Modulation (FAST), 64, 79, 166
 - GMSK ORFS, 187
 - Full Screen key, 321, 322, 323, 324, 325, 326, 328
- G**
- GMSK ORFS
 - average bursts setup, 187
 - burst sync setup, 189
 - fast averaging setup, 190
 - meas method
 - multi-offset, 79
 - multi-offset (list mode), 187
 - setup, 187
 - single offset (examine), 79, 187
 - swept, 80, 187
 - meas type
 - full frame (FAST), 79
 - full frame modulation (FAST), 187
 - mod & switch, 79, 187
 - modulation, 79, 187
 - switching, 79, 187
 - measurement results
 - Multi-Offset Modulation Margin & Limits view, 174, 194
 - Multi-Offset Modulation Power view, 173, 193
 - Multi-Offset Switching Margin & Limits view, 176, 196
 - Multi-Offset Switching Power view, 175, 195
 - measurement type setup, 187
 - offset freq setup, 189

- trigger source setup, 189
- GMSK Phase and Freq measurements, Continuous carrier, 534
- GPRS signals, making PvT measurements, 529
- GSM measurement, 410, 415, 419, 445, 449, 462, 502
- GSM standards
 - DCS 1800, 147, 523
 - E-GSM, 147, 523
 - GSM 1900, 147, 523
 - GSM 450, 147, 523
 - GSM 480, 147, 523
 - GSM 700, 147, 523
 - GSM 850, 147, 523
 - GSM 900, 147, 523
 - PCS 1900, 147, 523
 - P-GSM, 147, 523
 - R-GSM, 147, 523
- GSM450, 480
- GSM480, 480
- GSM850, 480
- H**
- hopping carriers, 478
- I**
- I and Q waveform view
 - I or Q waveform window, 231
 - I waveform window, 256
 - Q waveform window, 256
- I offset, 152
- I or Q waveform window
 - amplitude Y scale, 231
 - reference position, 232
 - reference value, 232
 - scale coupling, 232
 - scale per division, 232
- span X scale
 - reference position, 230, 253
 - reference value, 230, 253
 - scale coupling, 231, 253
 - scale per division, 230, 253
- I origin
 - I/Q polar window, 253, 254, 257
- I Origin key, 231, 232
- I waveform window
 - amplitude Y scale, 256
 - reference position, 257
 - scale coupling, 257
 - scale per division, 256
- I/Q data output, 136
- I/Q data results, 378, 385
- I/Q impedance reference, 153
- I/Q input impedance, 152
- I/Q marker query, 316, 317
- I/Q origin offset
 - phase & frequency error, 456
- I/Q origin offset meas, phase and freq measurement, 199
- I/Q Polar view
 - waveform measurement, 253, 257
- I/Q polar view
 - I/Q polar window, 231, 232, 253, 257
- I/Q polar window
 - amplitude Y scale, 232
 - I/Q scale per division, 231, 232
 - Q Origin, 231, 232
 - I origin, 253, 254, 257
 - I/Q scale per division, 253, 254, 257
 - Q origin, 253, 254, 257
 - span X scale, 231, 232
 - I Origin, 231, 232
- I/Q scale per division
 - I/Q polar window, 253, 254, 257
- I/Q Scale/Div key, 231, 232
- I/Q setup, 152
- I/Q waveform view
 - I/Q waveform window, 256
- I/Q waveform window, 253
 - amplitude Y scale, 256
 - reference position, 257
 - reference value, 256
 - scale coupling, 257
 - scale per division, 256
- IF Flatness
 - advanced spectrum feature, 221
- IF trigger delay, 518
- IF trigger level, 518
- IF trigger slope, 519
- improving measurement speed, 64, 79, 166, 187
- initial signal connection, 48
- INITiate commands, 351
- initiate measurement, 341, 342
- input
 - external attenuator, 154
 - attenuation for BTS tests, 154
 - attenuation for MS tests, 154
 - input attenuator, 154, 155
 - input port, 152
 - 50 MHz reference, 152
 - Baseband Align Signal, 152
 - rf, 152
 - max total power, 154
 - maximum total power, 153
 - RF input range, 153
- input attenuation, 459
- Input Key, 152
- input port
 - 50 MHz reference, 152
 - I only, 152
 - I/Q, 152
 - IF align, 152
 - Q only, 152
- input port selection, 435
- input power
 - maximum, 460
 - range, 460
- Install Now key, 40
- Installing and Obtaining a license key, 39
- installing measurement personalities, 35
- instrument configuration, 343
- internal reference, 482
- internal reference selection, 435
- Internal RF Preamp, 154
- IQ input selection, 435
- IQ port selection, 435
- K**
- key flow diagram
 - EDGE EVM Measurement, 568
 - EDGE ORFS Measurement, 568
 - EDGE PVT Measurement, 568
 - EDGE Tx Band Spur Measurement, 568
 - GMSK ORFS Measurement, 568
 - GMSK Phase and Freq. Measurement, 568
 - GMSK PVT Measurement, 568
 - Measurement selection, 568
 - Mode selection, 568
 - mode setup / frequency channel, 568
 - spectrum (frequency domain), 568
 - Transmit Power Measurement, 568
 - Tx Band Spur, 568
 - waveform (time domain), 568
- L**
- Length Ctrl key, 220
- Length key, 220
- license key
 - obtaining and installing, 39
- limit line testing, 272
- limit testing
 - TSPur, 300, 317
- linear envelope view
 - linear envelope window, 255
 - phase window, 256
- linear envelope window, 253
 - amplitude Y scale, 255

Index

- reference position, 255
 - reference value, 255
 - scale coupling, 256
 - scale per division, 255
 - linear spectrum window
 - amplitude Y scale
 - reference position, 231
 - reference value, 231
 - scale coupling, 231
 - scale per division, 231
 - span, 230
 - loading an
 - application/personality, 35
- M**
- major functional keys, 140
 - making measurements, 347
 - marker
 - I/Q query, 316, 317
 - markers, 301
 - assigning them to traces, 306
 - maximum, 304
 - minimum, 305
 - off, 306
 - trace assignment, 310, 311
 - turn off, 304
 - type, 305
 - valid measurement, 301
 - value, 311
 - value of, 304
 - x-axis location, 310, 311
 - y-axis, 311
 - masks
 - power vs. time, 422, 423, 424, 425, 426, 427, 428, 467, 468, 469, 470, 471, 472, 473
 - maximum value of trace data, 282
 - Mean Transmit Power, PvT
 - measurement, 52, 96, 209, 532
 - Mean Transmit Pwr, PvT
 - measurement, 52, 96, 210, 532
 - mean value of trace data, 282
 - MEASure command use, 347
 - MEASure commands, 349
 - measure setup
 - restore measurement defaults, 219, 242
 - measurement
 - error vector magnitude, 396
 - markers, 301
 - output RF spectrum, 402, 438
 - phase and frequency error, 454
 - power vs. time, 419, 462
 - query current, 319
 - spectrum (frequency domain), 484
 - transmit band spurs, 433, 499
 - transmit power, 502
 - waveform (time domain), 506
 - measurement key flow, 568
 - measurement method
 - output RF spectrum, 416, 452
 - measurement modes
 - currently available, 343
 - selecting, 343, 345
 - measurement setup
 - averaging mode, 217, 240
 - exponential, 217, 240
 - averaging number, 217, 240
 - averaging type, 218, 241
 - log power average (video), 218, 241
 - maximum voltage average, 218, 241
 - minimum voltage average, 218, 241
 - power average (rms), 218, 241
 - voltage average, 218, 241
 - measurement type
 - transmit band spurs, 434, 501
 - measurements
 - CONF/FETC/MEAS/READ
 - commands, 347
 - control of, 341
 - error vector magnitude, 353
 - getting results, 347
 - output RF spectrum, 357, 366
 - phase and frequency error, 370
 - power vs. time, 361, 373
 - setting default values remotely, 350
 - single/continuous, 341
 - spectrum (frequency domain), 378
 - transmit band spurs, 364, 382
 - transmit power, 383
 - waveform (time domain), 385
 - measuring I/Q data, 378, 385
 - measuring in the time domain, 129
 - Min Pts in RBW key, 220
 - minimum value of trace data, 282
 - missing options, 35
 - mobile station
 - loss correction, 395
 - mobile station testing, 479
- N**
- normal marker, 305
- O**
- offset frequency
 - output RF spectrum, 416, 453
 - options
 - loading/deleting, 35
 - options not in instrument
 - memory, 35
 - ORFS, 64, 79, 166, 171, 187, 191
 - ORFSpectrum
 - bandwidth, 408, 444, 449
 - bandwidth, 414
 - l offset
 - output RF spectrum
 - measurement, 410, 415, 445, 449
 - measurement type, 417, 454
 - offsets, 411, 415, 452
 - output RF spectrum
 - resolution bandwidth for
 - switching transients at close offsets, 405, 442
 - trigger source, 416, 453
 - output RF spectrum - averaging control, 403, 440
 - output RF spectrum - number of bursts averaged, 402, 439
 - output RF spectrum - offset frequency, 416, 453
 - output RF spectrum - offset frequency list, 447
 - output RF spectrum - resolution bandwidth for switching transients at far offsets, 406, 443, 444
 - output RF spectrum - resolution BW for modulation at close offsets, 404, 441
 - output RF spectrum - resolution BW for modulation at far offsets, 404, 442
 - output RF spectrum
 - measurement, 357, 366, 402, 438
 - See also ORFSpectrum
 - See also orfspectrum
 - output RF spectrum
 - measurement method, 416, 452
- P**
- packing
 - SPECTrum, 484
 - pass/fail test, 272
 - PCS, 480
 - PCS1900, 480
 - personalities
 - currently available, 343

- selecting, 343, 345
 - personality options not in instrument, 35
 - PGSM, 480
 - Phase & frequency error
 - I/Q origin offset, 456
 - phase & frequency error - averaging mode, 455
 - phase & frequency error - averaging state, 455
 - phase & frequency error - averaging type, 456
 - phase & frequency error - burst synchronization, 456
 - phase & frequency error - number of bursts averaged, 455
 - phase & frequency error - trace data, 457
 - phase & frequency error - trigger source, 457
 - phase and freq measurement, I/Q origin offset meas, 199
 - phase and freq measurement, Trace Data, 199
 - phase and frequency error measurement, 370, 454
 - See also PFERror
 - phase window, 253
 - amplitude Y scale, 256
 - reference position, 256
 - reference value, 256
 - scale per division, 256
 - Polar Mod Align key, 158
 - Polar Mod Sync key, 158
 - power threshold
 - setting, 498
 - power vs. time
 - averaging state, 419, 462
 - power vs. time - averaging mode, 419, 463
 - power vs. time - averaging type, 420, 463
 - power vs. time - custom limit masks, 428, 473
 - power vs. time - limit line mask display, 422, 467
 - power vs. time - lower mask
 - absolute amplitude levels, 423, 467
 - power vs. time - lower mask points, 423, 468
 - power vs. time - lower mask
 - relative amplitude levels, 424, 468
 - power vs. time - lower mask time points, 424, 469
 - power vs. time - number of bursts averaged, 419, 462
 - power vs. time - resolution
 - bandwidth, 420, 464
 - power vs. time - trigger source, 432, 476
 - power vs. time - upper mask
 - absolute amplitude levels, 425, 470
 - power vs. time - upper mask points, 426, 470
 - power vs. time - upper mask
 - relative amplitude levels, 426, 471
 - power vs. time - upper mask time points, 427, 472
 - power vs. time measurement, 361, 373, 419, 462
 - See also PVTime
 - pre-ADC bandpass filter
 - SPECTrum, 489
 - Pre-ADC BPF key
 - spectrum measurement, 219
 - Preamplifier
 - Setting the internal preamplifier, 154
 - pre-FFT bandwidth, SPECTrum, 489, 490
 - Pre-FFT BW key, 219
 - Pre-FFT Fltr key, 219
 - preset, 48
 - factory defaults, 48
 - preset states, 48, 146
 - procedure
 - using the waveform measurement, 129
 - programming
 - compatibility among PSA modes, 267, 269
 - compatibility, PSA series versus VSA, 270
 - PSA series versus VSA (programming compatibility), 270
 - PVT limits display, 321, 328
 - PvT measurement, Mean
 - Transmit Power, 52, 96, 209, 532
 - PvT measurement, Mean
 - Transmit Pwr, 52, 96, 210, 532
 - PvT measurements of GPRS
 - signals, 529
 - PVTime
 - bandwidth, 421, 465
 - sweep time, 431, 476, 504
- ## Q
- Q offset, 152
 - Q origin
 - I/Q Polar window, 253, 257
 - I/Q polar window, 254, 257
 - Q Origin key, 231, 232
 - Q waveform window
 - amplitude Y scale, 256
 - reference position, 257
 - reference value, 256
 - scale coupling, 257
 - scale per division, 256
 - query data, 272, 282
- ## R
- READ command use, 347
 - READ commands, 351
 - real number data format, 339
 - rear panel external trigger
 - delay, 515
 - slope, 516
 - reference
 - external, 482
 - internal, 482
 - reference, selecting internal, 435
 - Res BW key
 - spectrum measurement, 217
 - waveform measurement, 240
 - restart measurement, 342
 - results, waveform measurement, 557
 - return data, 272, 282
 - RF input selection, 435
 - RF input, selection, 435
 - RMS of trace data, 282
- ## S
- sampling trace data, 282
 - select the ARFCN - absolute RF channel number, 390
 - selecting channel, 392
 - sensors, temperature, 377
 - signal envelope view
 - signal envelope window, 255
 - signal envelope window, 253
 - amplitude Y scale, 255
 - reference position, 255
 - reference value, 255
 - scale coupling, 255
 - scale per division, 255
 - single vs. continuous
 - measurement mode, 341
 - slots, setting, 431, 476, 504
 - span
 - SPECTrum, 495
 - Span key

Index

- spectrum measurement, [217](#)
 - SPECTrum
 - acquisition packing, [484](#)
 - ADC range, [485](#)
 - data decimation, [491](#)
 - FFT length, [492](#), [493](#)
 - FFT resolution BW, [493](#)
 - FFT window, [494](#), [495](#)
 - FFT window delay, [494](#)
 - frequency span, [495](#)
 - sweep time, [496](#)
 - trigger source, [497](#)
 - spectrum
 - all traces, [230](#), [253](#)
 - averaged trace, [230](#), [253](#)
 - changing views, [106](#), [223](#)
 - current trace, [230](#), [253](#)
 - I signal trace, [230](#), [253](#)
 - next window selection, [223](#)
 - Q signal trace, [230](#), [253](#)
 - span X scale, [230](#)
 - trace display, [230](#), [253](#)
 - view/trace, [106](#), [223](#)
 - zoom a window, [223](#)
 - Spectrum (Frequency Domain)
 - key, [217](#), [556](#)
 - spectrum (frequency domain)
 - measurement, [378](#), [484](#)
 - See also SPECTrum
 - spectrum measurement
 - basic mode, [136](#)
 - method, [556](#)
 - results, [105](#), [223](#)
 - spectrum measurement display, [329](#), [330](#), [335](#), [336](#)
 - standard deviation of trace data, [282](#)
 - standard, selecting for GSM, [480](#)
 - start measurement, [341](#), [342](#)
 - state
 - changing, [388](#)
 - status
 - temperature measurement, [377](#)
 - sweep time
 - PVTime, [431](#), [476](#), [504](#)
 - SPECTrum, [496](#)
 - WAVEform, [512](#)
 - Sweep Time key, [240](#)
 - switching transients
 - ORFSpectrum, [414](#), [415](#), [449](#)
 - symbol dots
 - EVM, [398](#), [399](#), [400](#)
 - sync alignment, [498](#)
 - sync burst RF amplitude delay, [498](#)
 - synchronization, [498](#)
 - GSM, [498](#)
 - phase & frequency error, [456](#)
- T**
- T0 trig
 - burst sync, [178](#)
 - temperature sensor
 - measurement, [377](#)
 - test limits, [272](#)
 - tile the display, [327](#)
 - time domain measurement, [385](#), [506](#)
 - time domain measurements, [240](#), [557](#)
 - time offset unit key, [163](#)
 - time slot auto, [393](#)
 - time slot number, [393](#)
 - timebase frequency accuracy
 - measurement, [381](#)
 - timeslot
 - definition of, [525](#)
 - trace data
 - phase and frequency error
 - measurement, [457](#)
 - processing, [282](#)
 - Trace Data, phase and freq
 - measurement, [199](#)
 - trace display, [331](#)
 - trace format, [339](#)
 - trace names for markers, [306](#)
 - trace/view selection
 - magnitude & phase graph view, [124](#), [249](#)
 - training sequence code (TSC), [394](#)
 - training sequence code (TSC)
 - auto, [394](#)
 - training sequence code channel, [392](#)
 - training sequence code selection, [394](#)
 - transmit band spurs
 - limit testing, [300](#), [317](#)
 - transmit band spurs - average
 - count, [433](#), [499](#)
 - transmit band spurs - averaging
 - state, [388](#), [389](#), [433](#), [458](#), [500](#), [508](#)
 - transmit band spurs - averaging
 - termination control, [433](#), [500](#)
 - transmit band spurs - type, [434](#), [501](#)
 - transmit band spurs
 - measurement, [364](#), [382](#), [499](#)
 - transmit power
 - resolution bandwidth, [503](#)
 - transmit power - averaging mode, [502](#)
 - transmit power - averaging state, [502](#)
 - transmit power - averaging type, [503](#)
 - transmit power - number of bursts
 - averaged, [502](#)
 - transmit power measurement, [383](#), [502](#)
 - See also TXPower
 - Trigger
 - T0 burst sync, [178](#)
 - trigger
 - auto time, [514](#)
 - burst level, [519](#)
 - commands, [514](#)
 - delay, [515](#)
 - delay, IF, [518](#)
 - external, [515](#), [516](#)
 - frame adjustment, [516](#), [517](#)
 - frame period, [516](#)
 - frame sync mode, [517](#)
 - holdoff, [518](#)
 - level, [515](#)
 - level, IF, [518](#)
 - on/off, [514](#)
 - output RF spectrum, [416](#), [453](#)
 - phase & frequency error, [457](#)
 - power vs. time, [432](#), [476](#)
 - slope, [516](#)
 - slope, IF, [519](#)
 - SPECTrum, [497](#)
 - timeout, [514](#)
 - trigger source, [218](#), [241](#)
 - external front input, [218](#), [241](#)
 - external rear input, [218](#), [241](#)
 - frame clock, [218](#), [242](#)
 - free run (immediate), [218](#), [241](#)
 - line, [218](#), [242](#)
 - RF burst (wideband), [218](#), [241](#)
 - video (IF envelope), [218](#), [241](#)
 - TXPower, [505](#)
 - WAVEform, [513](#)
 - trigger measurement, [341](#), [342](#)
 - trigger source
 - EVM, [400](#)
 - triggering setup help, waveform
 - measurement, [129](#)
 - TSC (Training Sequence) Burst
 - Sync, EDGE EVM, [159](#)
 - TSPur
 - limit testing, [300](#), [317](#)
 - TXPower
 - trigger source, [505](#)
- U**
- Uninstall Now, [42](#)

uninstalling measurement personalities, 35

uplink
definition of, 525

V

view ACP data, 320

view commands, 320

view/trace

I/Q waveforms, 108, 227
linear spectrum and phase graphs, 107, 226
spectrum graph, 106, 223

view/trace selection

I and Q Waveform view, 124, 251

I and Q waveform view, 231

I/Q polar waveform view, 127, 252

I/Q waveform graph window, 106, 225

I/Q Waveform view, 124, 250

linear envelope and phase view, 121, 247

Spectrum I/Q Waveform view, 106, 225

spectrum linear

linear spectrum window, 230, 231

viewing the time domain, 129

VSA versus PSA series

(programming compatibility), 270

W

WAVEform

acquisition packing, 506

ADC filter, 507

ADC range, 507

data decimation, 511, 512

sweep time, 512

trigger source, 513

waveform

changing displays, 253

I and Q waveform view, 256

I/Q waveform view, 256

linear envelope view, 256

method, 557

resolution bandwidth, 240

results, 120

span X scale, 253

sweep time, 253

using markers, 257

Waveform (Time Domain) key, 557

Waveform (Time Domain) Key Menus, 240

waveform (time domain)

measurement, 385, 506

See also WAVEform

waveform measurement, 129, 240

basic mode, 136

display, 257

I/Q Polar view, 253, 257

results, 120

Window Length key, 220

Z

zero span measurement, 385, 506

zoom the display, 327

Index
